

NX100 OPERATOR'S MANUAL

FOR PAINTING

Upon receipt of the product and prior to initial operation, read these instructions thoroughly, and retain for future reference.

MOTOMAN INSTRUCTIONS

MOTOMAN-□□□ INSTRUCTIONS
NX100 INSTRUCTIONS
NX100 OPERATOR'S MANUAL
NX100 MAINTENANCE MANUAL

The NX100 operator's manuals above correspond to specific usage.
Be sure to use the appropriate manual.

YASKAWA ELECTRIC CORPORATION



 **MANDATORY**

- **This manual explains the various components of the NX100 system and general operations. Read this manual carefully and be sure to understand its contents before handling the NX100.**
- **General items related to safety are listed in Section 1: Safety of the NX100 Instructions. To ensure correct and safe operation, carefully read the NX100 Instruction before reading this manual.**

 **CAUTION**

- **Some drawings in this manual are shown with the protective covers or shields removed for clarity. Be sure all covers and shields are replaced before operating this product.**
- **The drawings and photos in this manual are representative examples and differences may exist between them and the delivered product.**
- **YASKAWA may modify this model without notice when necessary due to product improvements, modifications, or changes in specifications. If such modification is made, the manual number will also be revised.**
- **If your copy of the manual is damaged or lost, contact a YASKAWA representative to order a new copy. The representatives are listed on the back cover. Be sure to tell the representative the manual number listed on the front cover.**
- **YASKAWA is not responsible for incidents arising from unauthorized modification of its products. Unauthorized modification voids your product's warranty.**

Notes for Safe Operation

Read this manual carefully before installation, operation, maintenance, or inspection of the NX100.

In this manual, the Notes for Safe Operation are classified as “WARNING,” “CAUTION,” “MANDATORY,” or “PROHIBITED.”



WARNING

Indicates a potentially hazardous situation which, if not avoided, could result in death or serious injury to personnel.



CAUTION

Indicates a potentially hazardous situation which, if not avoided, could result in minor or moderate injury to personnel and damage to equipment. It may also be used to alert against unsafe practices.



MANDATORY

Always be sure to follow explicitly the items listed under this heading.



PROHIBITED

Must never be performed.

Even items described as “CAUTION” may result in a serious accident in some situations. At any rate, be sure to follow these important items.



NOTE To ensure safe and efficient operation at all times, be sure to follow all instructions, even if not designated as “CAUTION” and “WARNING.”



WARNING

- **Before operating the manipulator, check that servo power is turned OFF when the emergency stop buttons on the front door of the NX100 and programming pendant are pressed. When the servo power is turned OFF, the SERVO ON LED on the programming pendant is turned OFF.**

Injury or damage to machinery may result if the emergency stop circuit cannot stop the manipulator during an emergency. The manipulator should not be used if the emergency stop buttons do not function.

Emergency Stop Button



- **Once the emergency stop button is released, clear the cell of all items which could interfere with the operation of the manipulator. Then turn the servo power ON.**

Injury may result from unintentional or unexpected manipulator motion.

Release of Emergency Stop



- **Observe the following precautions when performing teaching operations within the P-point maximum envelope of the manipulator:**
 - **View the manipulator from the front whenever possible.**
 - **Always follow the predetermined operating procedure.**
 - **Ensure that you have a safe place to retreat in case of emergency.**

Improper or unintended manipulator operation may result in injury.

- **Confirm that no persons are present in the P-point maximum envelope of the manipulator and that you are in a safe location before:**
 - **Turning ON the NX100 power**
 - **Moving the manipulator with the programming pendant**
 - **Running the system in the check mode**
 - **Performing automatic operations**

Injury may result if anyone enters the P-point maximum envelope of the manipulator during operation. Always press an emergency stop button immediately if there are problems. The emergency stop buttons are located on the right of the front door of the NX100 and the programming pendant.



CAUTION

- **Perform the following inspection procedures prior to conducting manipulator teaching. If problems are found, repair them immediately, and be sure that all other necessary processing has been performed.**
 - Check for problems in manipulator movement.**
 - Check for damage to insulation and sheathing of external wires.**
- **Always return the programming pendant to the hook on the NX100 cabinet after use.**

The programming pendant can be damaged if it is left in the P-point maximum envelope of the manipulator, on the floor, or near fixtures.

- **Read and understand the Explanation of Warning Labels in the NX100 Instructions before operating the manipulator.**

Definition of Terms Used Often in This Manual

The MOTOMAN is the YASKAWA industrial robot product.

The MOTOMAN usually consists of the manipulator, the controller, the programming pendant, and manipulator cables.

In this manual, the equipment is designated as follows:

Equipment	Manual Designation
NX100 Controller	NX100
NX100 Programming Pendant	Programming Pendant
Cable between the manipulator and the controller	Manipulator cable

Descriptions of the programming pendant keys, buttons, and displays are shown as follows:

Equipment		Manual Designation
Programming Pendant	Character Keys	The keys which have characters printed on them are denoted with []. ex. [ENTER]
	Symbol Keys	The keys which have a symbol printed on them are not denoted with [] but depicted with a small picture. ex. page key  The cursor key is an exception, and a picture is not shown.
	Axis Keys Numeric Keys	"Axis Keys" and "Numeric Keys" are generic names for the keys for axis operation and number input.
	Keys pressed simultaneously	When two keys are to be pressed simultaneously, the keys are shown with a "+" sign between them, ex. [SHIFT]+[COORD]
	Displays	The menu displayed in the programming pendant is denoted with { }. ex. {JOB}

Description of the Operation Procedure

In the explanation of the operation procedure, the expression "Select •••" means that the cursor is moved to the object item and the SELECT key is pressed, or that the item is directly selected by touching the screen.

Registered Trademark

In this manual, names of companies, corporations, or products are trademarks, registered trademarks, or brand names for each company or corporation. The indications of (R) and TM are omitted.

1 Introduction

1.1	NX100 Overview	1-1
1.2	Programming Pendant	1-2
1.2.1	Programming Pendant Overview	1-2
1.2.2	Key Description	1-3
■	Character Keys	1-3
■	Symbol Keys	1-3
■	Axis Keys and Numeric Keys	1-3
■	Keys Pressed Simultaneously	1-3
1.2.3	Programming Pendant Keys	1-4
1.2.4	Programming Pendant Display	1-10
■	The Five Display Areas	1-10
■	General-purpose Display Area	1-11
■	Main Menu Area	1-12
■	Status Display Area	1-12
■	Human Interface Display Area	1-14
■	Menu Area	1-14
1.2.5	Screen Descriptions	1-14
■	Denotation	1-14
■	Screen	1-15
1.2.6	Character Input	1-15
■	Operation	1-16
■	Alphanumeric Input	1-17
■	Symbol Input	1-17
1.3	Modes	1-18
1.3.1	Teach Mode	1-18
1.3.2	Play Mode	1-18
1.3.3	Remote Mode	1-18
1.3.4	Teach Mode Priority	1-18
1.4	About the Security Mode	1-19
1.4.1	Types of Security Modes	1-19
1.4.2	Switching Security Modes	1-24

2 Manipulator Coordinate Systems and Operations

2.1	Control Groups and Coordinate Systems	2-1
2.1.1	Control Group	2-1
2.1.2	Types of Coordinate Systems	2-2
2.2	General Operations	2-3
■	Check Safety	2-3
■	Select Teach Mode	2-3
■	Select Control Group	2-3
■	Select Coordinate System	2-3
■	Select Manual Speed	2-3

■ Servo ON	2-4
■ Axis Operation	2-4
■ HIGH SPEED	2-4
2.3 Coordinate Systems and Axis Operation	2-5
2.3.1 Joint Coordinates	2-5
2.3.2 Cartesian Coordinates	2-6
2.3.3 Cylindrical Coordinates	2-7
2.3.4 Tool Coordinates	2-8
■ Selecting the Tool	2-9
2.3.5 User Coordinates	2-10
■ Selecting User Coordinates	2-12
■ Examples of User Coordinate Utilization	2-13
2.3.6 External Axis	2-13
2.3.7 Control Point Operation	2-14
2.3.8 Control Point Change	2-16

3 Teaching

3.1 Preparation for Teaching	3-1
3.1.1 Checking Emergency Stop Buttons	3-1
3.1.2 Setting the Teach Lock	3-1
3.1.3 Registering a Job	3-2
■ Registering Job Names	3-2
■ Registering Comments	3-3
■ Registering Control Groups	3-3
■ Switching to the Teaching Window	3-3
3.2 Teaching Operation	3-4
3.2.1 The Teaching Window	3-4
3.2.2 Interpolation Type and Play Speed	3-5
■ Joint Interpolation	3-5
■ Linear Interpolation	3-6
■ Circular Interpolation	3-7
■ Spline Interpolation	3-8
3.2.3 Teaching Steps	3-9
■ Registering Move Instructions	3-9
■ Registering Reference Point Instructions	3-15
■ Registering Timer Instructions	3-16
3.2.4 Overlapping the First and Last Steps	3-18
3.3 Checking Steps	3-19
3.3.1 FWD/BWD Key Operations	3-19
■ Precautions When Using FWD / BWD Operations	3-19
■ Selecting Manual Speed	3-21
■ Moving to Reference Point	3-22
■ Test Operations	3-22
3.4 Modifying Steps	3-23
3.4.1 Displaying the JOB CONTENT Window for Editing	3-27
■ Currently Called Up Job	3-27

■ Calling Up Other Jobs	3-27
3.4.2 Inserting Move Instructions	3-28
3.4.3 Deleting Move Instructions	3-29
3.4.4 Modifying Move Instructions	3-30
■ Modifying Position Data	3-30
■ Modifying Interpolation Type	3-30
3.4.5 Undo Operation	3-31
3.4.6 Modifying Reference Point Instructions	3-31
■ Deleting Reference Point Instructions	3-31
■ Modifying Reference Point Instructions	3-32
3.4.7 Modifying Timer Instructions	3-32
■ Deleting Timer Instructions	3-32
■ Modifying Timer Instructions	3-33
3.5 Modifying Jobs	3-34
3.5.1 Calling Up a Job	3-34
3.5.2 Windows Related to Job	3-34
■ JOB HEADER Window	3-34
■ JOB CONTENT Window	3-36
■ COMMAND POSITION Window	3-37
■ JOB CAPACITY Window	3-38
3.6 Editing Instructions	3-39
3.6.1 Instruction Group	3-39
3.6.2 Inserting Instructions	3-41
3.6.3 Deleting Instructions	3-44
3.6.4 Modifying Instructions	3-44
3.6.5 Modifying Additional Numeric Data	3-47
3.6.6 Modifying Additional Items	3-48
3.6.7 Inserting Additional Items	3-49
3.6.8 Deleting Additional Items	3-50
3.7 Editing Jobs	3-51
3.7.1 Selecting the Range	3-53
3.7.2 Copying	3-54
3.7.3 Cutting	3-54
3.7.4 Pasting	3-55
3.7.5 Reverse Pasting	3-56
3.8 Test Operations	3-57
3.9 Other Job-editing Functions	3-58
3.9.1 Editing Play Speed	3-58
■ Modification of Speed Type	3-58
■ Relative Modification	3-58
■ Modification by TRT (Traverse Time)	3-60
3.9.2 Editing Interpolation Type	3-62
3.9.3 Editing Condition Files	3-63
3.9.4 User Variables	3-64
■ Setting Byte, Integer, Double Precision Integer, and Real Type Variables	3-66
■ Setting Character Type Variables	3-67
■ Registering Variable Name	3-68

■	Displaying Position Variables	3-69
■	Setting Position Variables	3-70
■	Setting Position Variables Using the Numeric Keys	3-71
■	Setting Position Variables Using the Axis Keys	3-73
■	Deleting Data Set of Position Variables	3-74
■	Checking Positions by Position Variables	3-75
■	Manipulator Types	3-76
3.9.5	Editing Local Variables	3-80
■	Setting the Number of Local Variables	3-82
3.9.6	Searching	3-83
■	Line Search	3-84
■	Step Search	3-84
■	Label Search	3-85
■	Instruction Search	3-86
■	Tag Search	3-87

4 Playback

4.1	Preparation for Playback	4-1
4.1.1	Selecting a Job	4-1
■	Calling a Job	4-1
■	Registering the Master Job	4-2
■	Calling the Master Job	4-3
4.1.2	The PLAYBACK Window	4-5
■	Display of Cycle Time	4-6
■	Operation Cycle	4-6
4.2	Playback	4-8
4.2.1	Playback Operation	4-8
■	Selecting the Start Device	4-9
■	Servo On	4-9
■	Start Operation	4-9
4.2.2	Special Playback Operations	4-9
■	Low Speed Operation	4-10
■	Limited Speed Operations	4-10
■	Dry-run Speed Operations	4-11
■	Machine Lock Operation	4-11
■	Check Mode Operation	4-12
■	Weaving Prohibit Setting during Check Mode Operation	4-12
■	Cancel All Special Operations	4-12
4.3	Stop and Restart	4-13
4.3.1	Hold	4-13
■	Using the Programming Pendant	4-13
■	Using an External Input Signal (System Input)	4-13
4.3.2	Emergency Stop	4-14
■	Restart After Emergency Stop	4-15
4.3.3	Stop by Alarm	4-16
4.3.4	Others	4-17

■ Temporary Stop by Mode Change	4-17
■ Temporary Stop by the PAUSE Instruction	4-17
4.4 Modifying Play Speed	4-18
4.4.1 Speed Override	4-18
■ Setting Speed Overrides	4-20
■ Modifying Play Speed	4-21
■ Releasing Speed Override Settings	4-21
4.5 Playback with Reserved Start	4-22
4.5.1 Preparation for Reserved Start	4-22
■ Enabling Reserved Start	4-23
■ Registering Reserved Start I/O Signal	4-24
■ Registering Jobs to Stations	4-25
■ Deleting Registered Jobs from Stations	4-26
4.5.2 Playback from Reserved Start	4-27
■ Start Operation	4-27
■ Checking Job Reservation Status	4-28
■ Resetting Job Reservation	4-29
4.5.3 Hold Operation	4-30
■ [HOLD] on the Programming Pendant	4-30
■ Hold by External Input Signal (System Input)	4-30
■ Hold at the Station	4-31
4.6 Displaying Job Stack	4-32

5 Editing Jobs

5.1 Copying Jobs	5-2
5.1.1 Copying Jobs on the JOB CONTENT Window	5-2
5.1.2 Copying Jobs on the JOB LIST Window	5-4
5.2 Deleting Jobs	5-6
5.2.1 Deleting Jobs on the JOB CONTENT Window	5-6
5.2.2 Deleting Jobs on the JOB LIST Window	5-7
5.3 Modifying Job Names	5-8
5.3.1 Modifying Job Names on the JOB CONTENT Window	5-8
5.3.2 Modifying Job Names on the JOB LIST Window	5-10
5.4 Editing Comments	5-11
5.5 Setting Edit Lock on Individual Job Units	5-12
5.6 Enabling the Modification of Position Data Only ...	5-13

6 Convenient Functions

6.1 One-touch Operation “Direct Open”	6-1
6.2 Parallel Shift Function	6-3
6.2.1 Function Overview	6-3

6.2.2	Setting the Shift Value	6-5
■	Registering Position Variables	6-5
■	Coordinate Systems	6-5
■	Setting the Shift Value	6-6
6.2.3	Registering Shift Instructions	6-7
■	SFTON Instruction	6-8
■	SFTOF Instruction	6-10
■	MSHIFT Instruction	6-10
6.2.4	Continuation of the Parallel Shift Function	6-13
6.2.5	Examples of Use	6-14
■	Example of Use of Shift Addition/Subtraction	6-14
■	Example of Use of MSHIFT Instruction	6-15
6.3	Parallel Shift Job Conversion Function	6-16
6.3.1	Function Overview	6-16
6.3.2	Coordinate Systems for Conversion	6-17
6.3.3	Executing the Parallel Shift Job Conversion	6-22
■	Window Display	6-22
■	Parallel Shift Job Conversion Operation	6-23
6.3.4	Specifying the Shift Value by Position Variables	6-29
■	Window Display	6-29
■	Jobs Targeted for Conversion	6-30
■	Conversion of Coordinated Jobs	6-31
■	Operation Procedure	6-34
6.4	PAM Function	6-35
6.4.1	Function Overview	6-35
■	Input Ranges for Adjustment Data	6-35
6.4.2	Operating Methods	6-37
■	Setting Adjustment Data	6-37
■	Executing the Adjustment	6-39
■	Editing Data	6-40
6.5	Mirror Shift Function	6-43
6.5.1	Function Overview	6-43
6.5.2	Pulse Mirror-shift Function	6-43
■	Parameter Setting	6-43
■	Object Job	6-44
■	Group Axes Specification	6-44
■	Position Variables	6-44
6.5.3	Robot-coordinates Mirror-shift Function	6-44
■	Object Job	6-44
■	Group Axes Specification	6-44
■	Position Variables	6-45
6.5.4	User-coordinates Mirror-shift Function	6-45
■	Object Job	6-45
■	Group Axes Specification	6-45
■	Position Variables	6-45
6.5.5	Notes on the Mirror Shift Function	6-46
6.5.6	Operation Procedures	6-47
■	Calling Up the JOB CONTENT Window	6-47
■	Mirror Shift Conversion	6-47

■ Explanation of the Mirror Shift Window	6-48
--	------

7 External Memory Devices

7.1 Memory Devices	7-1
7.1.1 Compact Flash (CF Cards)	7-2
■ Recommended Compact Flash Cards	7-2
■ Notes on handling Compact Flash	7-3
■ Inserting a Compact Flash	7-4
7.2 Handling Data	7-5
7.2.1 Normal Mode Data Classification	7-5
7.2.2 Collective Backup	7-8
■ CMOS.BIN	7-8
■ CMOSBK.BIN	7-8
■ CMOSxx.HEX	7-8
■ ALCMSxx.HEX	7-8
7.2.3 File Existence	7-9
■ Saving by Overwriting	7-9
7.3 Operation Flow	7-10
■ Operating a Folder	7-11
■ Saving Data	7-15
■ Loading Data	7-27
■ Verifying Data	7-38
■ Deleting Data	7-41
■ Job Selection Mode	7-43

8 Parameter

8.1 Parameter Configuration	8-1
8.2 Motion Speed Setting Parameters	8-2
■ S1CxG000: IN-GUARD SAFE OPERATION MAX. SPEED	8-2
■ S1CxG001: DRY-RUN SPEED	8-2
■ S1CxG002 to S1CxG009: JOINT SPEED FOR REGISTRATION	8-2
■ S1CxG010 to S1CxG017: LINEAR SPEED FOR REGISTRATION	8-2
■ S1CxG018 to S1CxG025: POSITION ANGLE SPEED	8-3
■ S1CxG026 to S1CxG029: JOG OPERATION ABSOLUTE VALUE SPEED	8-3
■ S1CxG030 to S1CxG032: INCHING MOVE AMOUNT	8-3
■ S1CxG033 to S1CxG040: POSITIONING ZONE	8-3
■ S1CxG044: LOW-SPEED START	8-4
■ S1CxG045 to S1CxG048: JOG OPERATION LINK SPEED	8-5
■ S1CxG056: WORK HOME POSITION RETURN SPEED	8-5

■ S1CxG057: SEARCH MAX. SPEED	8-5
■ S2C153: POSTURE CONTROL AT CARTESIAN OPERATION OF JOG.....	8-5
■ S2C154: OPERATION IN USER COORDINATE SYSTEM (WHEN EXTERNAL REFERENCE POINT CONTROL FUNCTION USED).....	8-5
■ S2C238: CONTROLLED GROUP JOB TEACHING POSITION CHANGE.....	8-6
■ S2C324, S2C325: OPERATION AFTER RESET FROM PATH DEVIATION.....	8-6
■ S2C326: DEVIATED POSITION.....	8-8
■ S2C327: CIRCULAR INTERPOLATION TOOL POSITION CONTROL	8-8
■ S2C515: EMERGENCY STOP CURSOR ADVANCE CONTROL FUNCTION.....	8-9
■ S2C516: EMERGENCY STOP CURSOR ADVANCE CONTROL FUNCTION CONT PROCESS COMPLETION POSITION	8-9
■ S2C517: EMERGENCY STOP ADVANCE CONTROL FUNCTION WORK START INSTRUCTION STEP MOTION COMPLETION DELAY TIME	8-10
■ S2C560: BASE AXIS OPERATION KEY ALLOCATION SETTING	8-10
■ S3C806 to S3C808: POSITION CORRECTING FUNCTION DURING PLAYBACK	8-10
8.3 Mode Operation Setting Parameters.....	8-11
■ S2C147: SECURITY MODE WHEN CONTROL POWER SUPPLY IS TURNED ON.....	8-11
■ S2C148: SELECTION OF CARTESIAN/CYLINDRICAL.....	8-11
■ S2C149: COORDINATE SWITCHING PROHIBITED	8-11
■ S2C150: EXECUTION UNITS AT “FORWARD” OPERATION.....	8-12
■ S2C151: INSTRUCTION (EXCEPT FOR MOVE) EXECUTION AT “FORWARD” OPERATION	8-12
■ S2C155: CHANGING STEP ONLY	8-12
■ S2C156: MANUAL SPEED STORING FOR EACH COORDINATE	8-12
■ S2C158: ADDITIONAL STEP POSITION.....	8-13
■ S2C159: MASTER JOB CHANGING OPERATION.....	8-13
■ S2C160: CHECK AND MACHINE-LOCK KEY OPERATION IN PLAY MODE	8-14
■ S2C161: RESERVED WORK JOB CHANGING OPERATION.....	8-14
■ S2C162: MASTER OR SUBMASTER CALL OPERATION IN PLAY MODE	8-14
■ S2C163: LANGUAGE LEVEL.....	8-14
■ S2C166: INSTRUCTION INPUT LEARNING FUNCTION	8-15
■ S2C167: ADDRESS SETTING WHEN CONTROL	

POWER IS TURNED ON.	8-15
■ S2C168: JOB LIST DISPLAY METHOD AT JOB SELECTION.	8-15
■ S2C169: INITIAL OPERATION OF MANIPULATOR	8-15
■ S2C170: PLAYBACK EXECUTION AT CYCLE MODE "1- STEP"	8-16
■ S2C171: EXTERNAL START	8-16
■ S2C172: PROGRAMMING PENDANT START.	8-16
■ S2C173: SPEED DATA INPUT FORM	8-16
■ S2C174: RESERVED START.	8-17
■ S2C176: JOB SELECTION AT REMOTE FUNCTION (PLAY MODE)	8-17
■ S2C177: EXTERNAL MODE SWITCH	8-17
■ S2C179: EXTERNAL CYCLE SWITCHING	8-17
■ S2C180: PROGRAMMING PENDANT CYCLE SWITCHING	8-17
■ S2C181: SERVO ON FROM EXTERNAL PP PROHIBITION	8-18
■ S2C182: PROGRAMMING PENDANT OPERATION WHEN "IO" IS SELECTED FOR REMOTE MODE	8-18
■ S2C186: STEP REGISTRATION AT TOOL NO. CHANGE	8-18
■ S2C211: REMOTE FIRST CYCLE MODE	8-19
■ S2C212: LOCAL FIRST CYCLE MODE	8-19
■ S2C230: POWER ON FIRST CYCLE MODE	8-19
■ S2C231: TEACH MODE FIRST CYCLE MODE	8-19
■ S2C232: PLAY MODE FIRST CYCLE MODE	8-19
■ S2C297: SIGNAL NAME ALIAS FUNCTION	8-20
■ S2C298: VARIABLE NAME ALIAS FUNCTION	8-21
■ S2C299: I/O VARIABLE CUSTOMIZE FUNCTION	8-22
■ S2C317 to S2C321: TIME RESET	8-23
■ S2C333: TOOL NO. SWITCHING.	8-23
■ S2C335: POSITION TEACHING BUZZER	8-23
■ S2C336: JOB LINKING DESIGNATION (When Twin Synchronous Function Used)	8-24
■ S2C339: PLAYBACK OPERATION CONTINUATION FUNCTION	8-25
8.4 Parameters according to Interference Area	8-26
■ S1CxG200 to S1CxG215: PULSE SOFT LIMIT	8-26
■ S2C001: CUBE SOFT LIMIT CHECK.	8-27
■ S2C002: S-AXIS INTERFERENCE CHECK.	8-27
■ S2C003 to S2C050: CUBE/AXIS INTERFERENCE CHECK.	8-28
■ S2C051 to S2C114: CUBE USING METHOD.	8-30
■ S2C188 to S2C193: ROBOT INTERFERENCE CHECK	8-32
■ S3C000 to S3C023: CUBE SOFT LIMIT.	8-32
■ S3C024 to S3C031: S-AXIS INTERFERENCE AREA	8-33
■ S3C032 to S3C543: CUBIC INTERFERENCE AREA.	8-33
■ S3C801 to S3C804: ROBOT INTERFERENCE AREA.	8-33

■ S3C805: A SIDE LENGTH OF WORK-HOME-POSITION CUBE	8-33
8.5 Parameters according to Status I/O	8-33
■ S2C187: USER OUTPUT RELAY WHEN CONTROL POWER IS ON	8-33
■ S4C000 to S4C007: PARITY OF USER INPUT GROUPS	8-34
■ S4C008 to S4C015: PARITY OF USER OUTPUT GROUPS	8-35
■ S4C016 to S4C023: DATA OF USER INPUT GROUPS	8-36
■ S4C024 to S4C031: DATA OF USER OUTPUT GROUPS	8-37
■ S4C032 to S4C039: USER OUTPUT GROUP TO BE INITIALIZED AT SWITCHING MODE	8-38
■ S4C126: USER OUTPUT NO. WHEN MANIPULATOR DROP ALLOWABLE RANGE ERROR OCCURS	8-38
8.6 Parameters according to Coordinated or Synchronized Operation	8-38
■ S2C164: +MOV or +SMOV INSTRUCTION SPEED INPUT	8-39
■ S2C165: +MOV INSTRUCTION INTERPOLATION INPUT	8-39
■ S2C183: OPERATION METHOD AT FWD/BWD OPERATION OR TEST RUN BY INDEPENDENT CONTROL	8-39
■ S2C184: JOB AT CALLING MASTER OF SUBTASK 1, 2, 3, 4, 5, 6, 7 BY INDEPENDENT CONTROL	8-40
■ S2C194: STATION AXIS CURRENT VALUE DISPLAY FUNCTION	8-40
■ S2C195 to S2C206: STATION AXIS DISPLAYED UNIT ..	8-40
■ S2C322: POSTURE CONTROL OF SYNCHRONIZED MANIPULATOR (When Twin Synchronous Function Used)	8-41
■ S2C323: POSTURE CONTROL OF MANIPULATOR IN MULTI-JOB (When Twin Synchronous Function Used)	8-41
■ S2C549: OPERATION OF JOB WITHOUT CONTROL GROUP SPECIFICATION	8-41
■ S2C550: EXECUTION OF "BWD" OPERATION	8-42
■ S3C809: MAXIMUM DEVIATION ANGLE OF CURRENT STATION POSITION (When Twin Synchronous Function Used)	8-42
8.7 Parameters for Other Functions or Applications ...	8-43
■ S1CxG049 to S1CxG051: SMALL CIRCLE CUTTING ...	8-43
■ S1CxG052 to S1CxG053: SMALL CIRCLE CUTTING DIRECTION LIMIT VALUE	8-43

■	S1CxG054 to S1CxG055: SMALL CIRCLE CUTTING OVERLAP VALUE	8-43
■	S1CxG063, S1CxG064: PATTERN CUTTING DIMENSION	8-43
■	S1CxG065: MIRROR SHIFT SIGN INVERSION	8-43
■	S2C332: RELATIVE JOB OPERATION METHOD	8-44
■	S3C819 to S3C898: ANALOG OUTPUT FILTER CONSTANT (When analog output corresponding to speed function is used)	8-44
■	S3C899: CUT WIDTH CORRECTION VALUE (When form cutting function is used)	8-44
8.8	Hardware Control Parameters	8-44
■	S2C508: ANTICIPATOR FUNCTION	8-44
■	S2C646 to S2C648: COOLING FAN ALARM DETECTION	8-45
■	S4C181 to S4C212: SETTING OF OPERATING RELAY NO.	8-45
■	S4C213 to S4C244: OPERATING METHOD OF RELAYS	8-46
■	S2C649 to S2C651: COOLING FAN ALARM 1 OPERATION	8-46
■	S2C652 to S2C654: COOLING FAN ALARM 2 OPERATION	8-46
■	S2C655 to S2C657: COOLING FAN ALARM 3 OPERATION	8-46
■	S2C658 to S2C660: FAN ALARM 1 POWER SOURCE STATUS	8-47
■	S2C661 to S2C663: FAN ALARM 2 POWER SOURCE STATUS	8-47
■	S2C664 to S2C666: FAN ALARM 3 POWER SOURCE STATUS	8-47
8.9	TRANSMISSION PARAMETERS	8-47
■	RS000: COMMUNICATION PROTOCOL	8-47
8.9.1	Basic Protocol	8-47
■	RS030: NUMBER OF DATA BITS	8-47
■	RS031: NUMBER OF STOP BITS	8-47
■	RS032: PARITY	8-47
■	RS033: TRANSMISSION SPEED	8-47
■	RS034: RESPONSE WAITING TIMER (TIMER A)	8-47
■	RS035: TEXT TERMINATION MONITORING TIMER (TIMER B)	8-47
■	RS036: NUMBER OF ENQ RE-TRANSMISSION RETRIES	8-48
■	RS037: NUMBER OF DATA RE-TRANSMISSION RETRIES	8-48
■	RS038: BLOCK CHECK METHOD	8-48
8.9.2	FC1 Protocol	8-48
■	RS050: NUMBER OF DATA BITS	8-48
■	RS051: NUMBER OF STOP BITS	8-48

■ RS052: PARITY	8-48
■ RS053: TRANSMISSION SPEED	8-48
■ RS054: RESPONSE WAITING TIMER (TIMER A)	8-48
■ RS055: TEXT TERMINATION MONITORING TIMER (TIMER B)	8-48
■ RS056: NUMBER OF ENQ RE- TRANSMISSION RETRIES	8-48
■ RS057: NUMBER OF DATA RE- TRANSMISSION RETRIES	8-49
■ RS058: FC2 FORMAT SPECIFICATION	8-49
■ RS059: EXTERNAL MEMORY FILE OVERWRITE SPECIFICATION	8-49
8.10 Application Parameters	8-49
8.10.1 Arc Welding	8-49
■ AxP000: APPLICATION	8-49
■ AxP003: WELDING ASSIGNMENT OF WELDING START CONDITION FILE	8-49
■ AxP004: WELDING ASSIGNMENT OF WELDING END CONDITION FILES	8-49
■ AxP005: WELDING SPEED PRIORITY	8-50
■ AxP009: WORK CONTINUING	8-50
■ AxP010: WELDING INSTRUCTION OUTPUT	8-50
■ AxP011, AxP012: MANUAL WIRE OPERATION SPEED ..	8-50
■ AxP013, AxP014: WELDING CONTROL TIME	8-50
■ AxP015 to AxP017: NUMBER OF WELDING CONTROL ..	8-50
■ AxP026 to AxP029: TOOL ON/OFF USER OUTPUT NO. (Jigless system)	8-50
8.10.2 Handling Application	8-50
■ AxP002, AxP004: f1 KEY FUNCTION	8-50
■ AxP003, AxP005: f2 KEY FUNCTION	8-51
8.10.3 Spot Welding	8-51
■ AxP003: MAXIMUM NUMBERS OF CONNECTED POWER SOURCES	8-51
■ AxP004: GUN FULL OPEN STROKE ON/OFF SIGNAL ..	8-51
■ AxP005: STROKE CHANGE ANSWER TIME LIMIT	8-51
■ AxP006: PARITY SPECIFICATION FOR WELDING CONDITIONS	8-51
■ AxP007: ANTICIPATE TIME	8-51
■ AxP015: WELDING ERROR RESET OUTPUT TIME	8-52
■ AxP016, AxP017: ELECTRODE WEAR AMOUNT ALARM VALUE	8-52
8.10.4 General-purpose Application	8-52
■ AxP009: WORK CONTINUE PROHIBIT	8-52

9 Painting Application

9.1 Function Keys	9-1
9.2 Outline of Operations and Painting Functions	9-3

9.2.1	Example of Painting System Configuration	9-3
9.2.2	Settings for Panting System When Using a Spray Gun	9-4
9.2.3	Settings for Painting System When Using a Bell Gun	9-4
9.3	Teaching for Painting Operations	9-5
9.4	Anticipation Output Function	9-7
9.4.1	Example	9-7
9.4.2	Notes on Anticipation Output Function	9-8
9.5	Registering Work Instructions	9-9
9.5.1	SPYON	9-9
■	Registering the SPYON Instruction	9-9
■	Registering the SPYON Instruction in a One-touch Operation	9-13
9.5.2	Notes on the SPYON Instruction	9-14
9.5.3	SPYOF	9-15
■	Registering the SPYOF Instruction	9-15
■	Registering the SPYOF Instruction in a One-touch Operation	9-19
9.5.4	Notes on the SPYOF Instruction	9-20
9.5.5	PAINTSET	9-21
■	Registering the PAINSET Instruction	9-21
9.5.6	CALL	9-27
■	What Is the Job Registration Table?	9-27
■	Registering the Job Registration Table	9-29
■	Registering the CALL Instruction (JET)	9-31
9.6	Painting Condition File	9-37
9.7	Managing Painting Condition Files	9-37
9.8	Editing Painting Condition Files	9-39
9.8.1	Calling Up Painting Condition Files	9-39
9.8.2	Registering Painting Condition Files	9-40
9.9	Painting System Setting File	9-42
9.9.1	Calling Up Painting System Setting Files	9-44
9.9.2	Editing Painting System Setting Files	9-45
9.10	Painting System Characteristics Setting File	9-47
9.10.1	Editing Painting System Characteristics Setting Files	9-49
9.10.2	ON Timing of the Work Start Instruction for the SPYON Instruction	9-51
9.10.3	OFF Timing of the Work Start Instruction for the SPYOF Instruction	9-51
9.10.4	Notes on the ON/OFF Timing of the Work Start Instruction	9-52
9.11	Work Instruction List	9-54

10 Table of Basic Instructions

10.1	Move Instructions	10-1
-------------	-----------------------------	------

10.2	I/O Instructions	10-5
10.3	Control Instructions	10-8
10.4	Shift Instructions	10-11
10.5	Operating Instructions	10-12

11 Error

11.1	Error Message List	11-1
11.1.1	System and General Operation	11-2
11.1.2	Editing	11-5
11.1.3	Job Defined Data	11-5
11.1.4	External Memory Equipment	11-9
11.1.5	Concurrent I/O	11-15
11.1.6	Maintenance Mode	11-16

1 Introduction

1.1 NX100 Overview

The main power switch and the door lock are located on the front of the NX100 controller. The emergency stop button is installed in the upper right corner of the cabinet door and the programming pendant hangs from a hook below the button. For information on setup, installation, and connection of the NX100 system, refer to the “NX100 INSTRUCTIONS.”

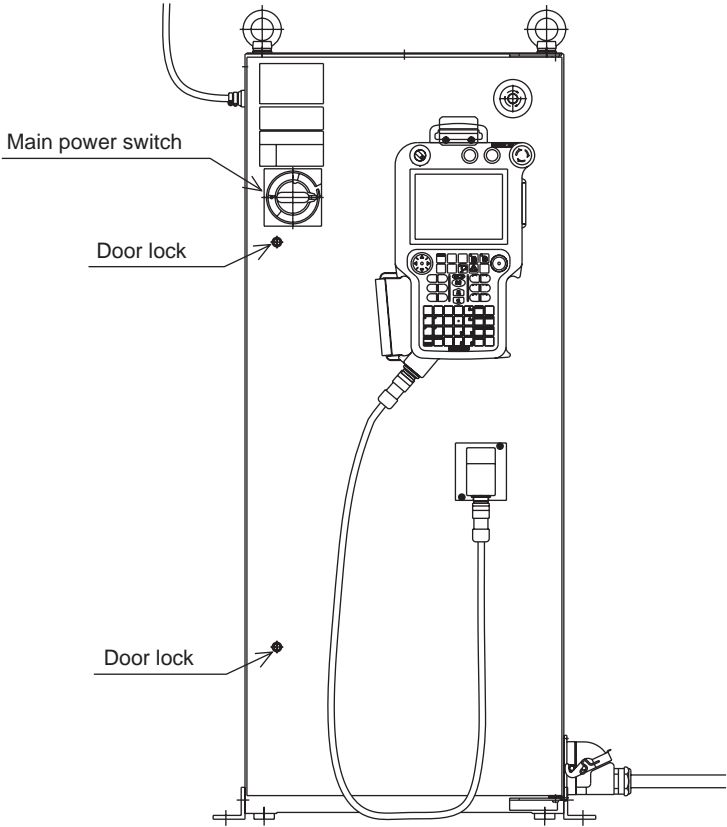

NX100 Front View

1.2 Programming Pendant

1.2.1 Programming Pendant Overview

The programming pendant is equipped with the keys and buttons used to conduct manipulator teaching operations and to edit jobs.

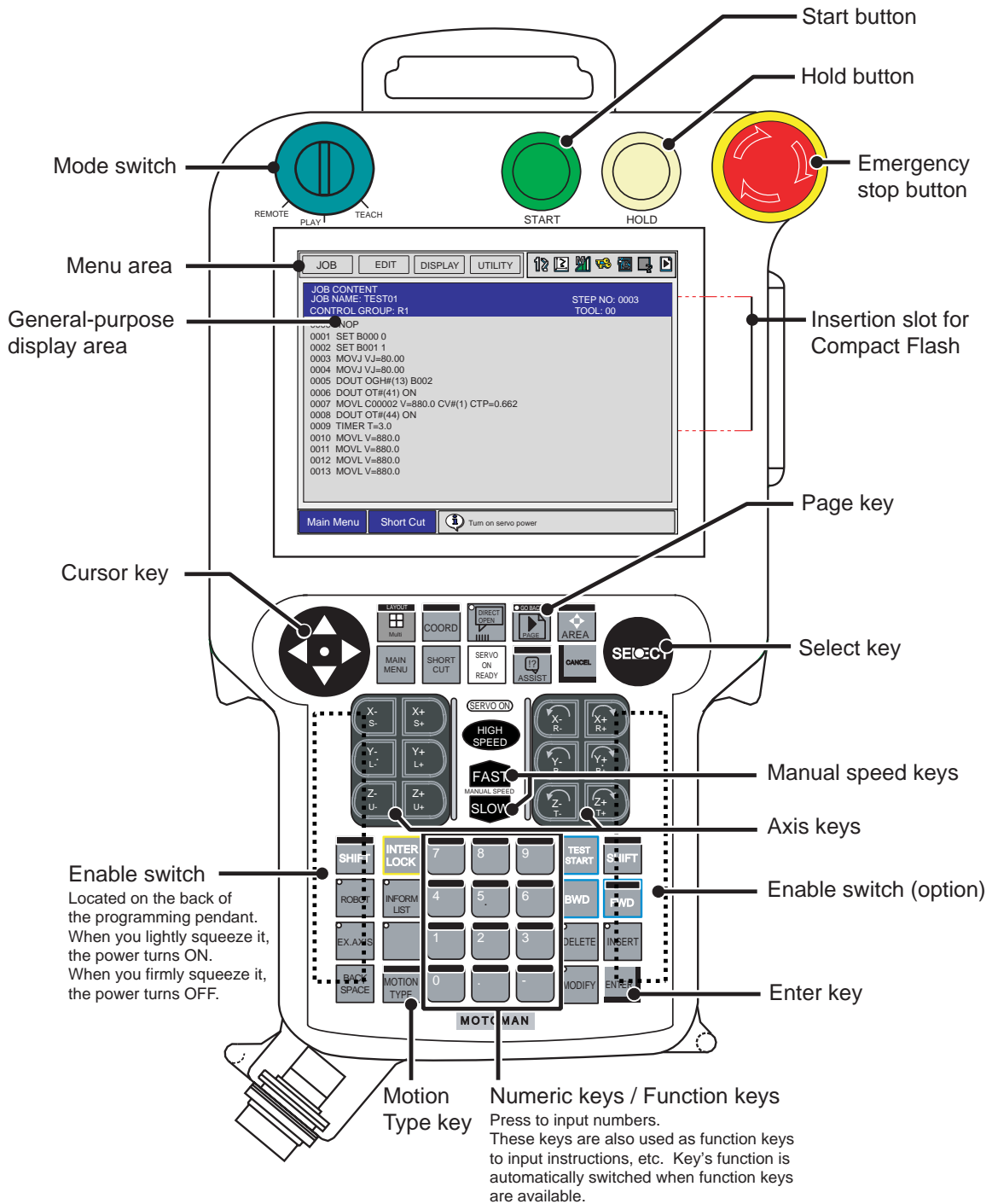

1.2.2 Key Description

■ Character Keys

The keys which have characters printed on them are denoted with []. For example,  is shown as [ENTER].

The Numeric keys have additional functions along with their number values. Dual function keys are used in the context of the operation being performed. For example:  may be described in the text as [1] or [TIMER].

■ Symbol Keys

The keys which have a symbol printed on them are not denoted with [] but depicted with a small picture, with the exception of the cursor key, which is not shown with a picture.



Cursor



Emergency Stop button



Direct Open key



Page key

■ Axis Keys and Numeric Keys

The keys pictured in the following are referred to as the axis keys and Numeric keys when described.

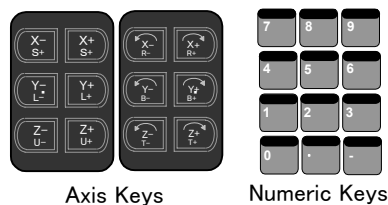





Axis Keys







Numeric Keys





■ Keys Pressed Simultaneously









When two keys are to be pressed simultaneously, the keys are shown with a “+” sign between them, such as [SHIFT]+[COORD].







1.2.3 Programming Pendant Keys





<p>E.STOP Button</p> 	<p>Turns OFF the servo power. When the servo power is turned OFF, the SERVO ON LED on the programming pendant will extinguish. An emergency stop message is displayed on the screen.</p>
<p>Enable Switch</p> 	<p>Turns ON the servo power. The Enable switch is active only when the SERVO ON LED is blinking, the safety plug is ON, and the Mode Switch is set to "TEACH." When this switch is lightly squeezed, the power turns ON. When firmly squeezed, the power turns OFF.</p>
<p>Cursor</p> 	<p>Moves the cursor in the direction of the arrow. The size of the cursor and the range/place where the cursor can move will vary depending on the window. If the UP cursor button is pressed when the cursor is on the first line, the cursor will move to the last line of the job. Conversely, if the cursor is on the last line of the job and the DOWN cursor button is pressed, the cursor will jump to the first line of the job.</p> <ul style="list-style-type: none"> • [SHIFT] + UP Scrolls the screen upward. • [SHIFT] + DOWN Scrolls the screen downward. • [SHIFT] + RIGHT Scrolls the screen to the right. • [SHIFT] + LEFT Scrolls the screen to the left.
<p>[SELECT]</p> 	<p>Selects menu items such as main menu, pull-down menu, etc.</p>
<p>[MAIN MENU]</p> 	<p>Displays the main menu. When pressed while the main menu is displayed, the main menu disappears.</p>

<p>[AREA]</p> 	<p>Moves the cursor between “Menu Area” and “General Purpose Display Area.” When [SHIFT] is pressed simultaneously:</p> <ul style="list-style-type: none"> • [SHIFT] + [AREA] The language can be switched when the bilingual function is valid. (Bilingual function is optional.) • DOWN cursor button + [AREA] Moves the cursor to the operation button on the screen if displayed. • UP cursor button + [AREA] Moves the cursor to the general-purpose display area when the cursor is on the operation button.
<p>[PAGE]</p> 	<p>Displays the next page.</p> <p>[SHIFT] + [PAGE] The previous page is displayed.</p> <p>The page can be changed when  appears in the status area on the screen.</p>
<p>[DIRECT OPEN]</p> 	<p>Displays the content related to the current line.</p> <p>To display the content of a CALL job or condition file, move the cursor to the next line and press [DIRECT OPEN]. The file will be displayed for the selected line. Display content will vary depending on the type of instruction used in the job.</p> <p>Example: For a CALL instruction, the content of the called job will be displayed. For a work instruction, the content of the condition file will be displayed. For Input/output instructions, the input/output condition will be displayed.</p>
<p>[COORD]</p> 	<p>Select the operation coordinate system when the manipulator is operated manually.</p> <p>Five coordinate systems (joint, cartesian, cylindrical, tool and user) can be used. Each time this key is pressed, the coordinate system is switched in the following order: "JOINT"→"WLD/CYL"→"TOOL"→"USER" The selected coordinate system is displayed on the status display area.</p> <p>[SHIFT] + [COORD] The coordinate number can be changed when the "TOOL" or "USER" coordinate system is selected.</p>
<p>MANUAL SPEED keys</p> 	<p>Sets the speed for manual operation.</p> <p>This speed is also valid for operations with [FWD] and [BWD]. There are four speed levels (slow, medium, fast, and inching). Each time [FAST] is pressed, manual speed changes in the following order: "INCH"→" SLOW"→"MED"→"FST" Each time [SLOW] is pressed, manual speed changes in the following order: "FST"→" MED"→"SLOW"→"INCH" The selected speed is displayed on the status area.</p>
<p>[HIGH SPEED]</p> 	<p>Changes the speed of axis operation when the axis button is pressed.</p> <p>The speed of the manipulator will change to high regardless of the programmed speed while this key is pressed. The speed for [HIGH SPEED] is specified in advance.</p>

<p>[MOTION TYPE]</p> 	<p>Selects the interpolation type for playback operation. The selected interpolation type is shown in the status display area on the screen.</p> <p>Each time this key is pressed, the interpolation type changes in the following order: "MOVJ" → " MOVL" → "MOV C" → "MOV S"</p> <p>[SHIFT] + [MOTION TYPE] The interpolation mode changes in the following order: "STANDARD" → " EXTERNAL REFERENCE POINT"* → " CONVEYOR"*</p> <p>Interpolation type can be changed in any mode.</p> <p>*: These modes are purchased options.</p>
<p>[ROBOT]</p> 	<p>Enables the robot axis operation.</p> <p>[ROBOT] is active for the system where multiple manipulators are controlled by one NX100 or the system with external axes.</p>
<p>[EX.AXIS]</p> 	<p>Enables the external axis (base axis or station axis) operation.</p> <p>[EX.AXIS] is active for the system with external axes.</p>
<p>Axis Key</p> 	<p>Moves specified axes on manipulator. The manipulator axes only move while the key is held down. Multiple axes can be operated simultaneously by pressing two or more keys at the same time.</p> <p>The manipulator operates in the selected coordinate system at the selected manual speed. Make sure that the selected coordinate system and the manual speed are the desired ones before starting the axis operation.</p>
<p>[TEST START]</p> 	<p>Moves the manipulator through taught steps in a continuous motion when [TEST START] and [INTERLOCK] are simultaneously pressed. The manipulator can be moved to check the path of taught steps. The manipulator operates according to the currently selected operation cycle: "AUTO," "1CYCLE," or "STEP." The manipulator operates at the taught speed. However, if the taught speed exceeds the maximum teaching speed, the operation proceeds at the maximum teaching speed. Operation stops immediately when this key is released.</p>

<p>[FWD]</p> 	<p>Moves the manipulator through the taught steps while this key is pressed. Only move instructions are executed (one instruction at a time, no welding instructions).</p> <p>[INTERLOCK] + [FWD] All instructions are executed.</p> <p>[REFP] + [FWD] Moves to the reference point of the cursor line. See "■ Moving to Reference Point" in " 3.3.1 FWD/BWD Key Operations ".</p> <p>The manipulator operates at the selected manual speed. Make sure that the selected manual speed is the desired one before starting operation.</p>
<p>[BWD]</p> 	<p>Moves the manipulator through the taught steps in the reverse direction while this key is pressed. Only move instructions are executed (no weld commands).</p>
<p>[INFORM LIST]</p> 	<p>Displays instruction lists of commands available for job editing.</p>
<p>[CANCEL]</p> 	<p>Cancels data input and resets errors.</p>
<p>[DELETE]</p> 	<p>Deletes registered instructions and data. Deletion completes when [ENTER] is pressed while this key lamp is lit.</p>
<p>[INSERT]</p> 	<p>Inserts new instructions or data. Insertion completes when [ENTER] is pressed while this key lamp is lit.</p>
<p>[MODIFY]</p> 	<p>Modifies taught position data, instructions, and data. Modification completes when [ENTER] is pressed while this key lamp is lit.</p>
<p>[ENTER]</p> 	<p>Registers instructions, data, current position of the manipulator, etc. When [ENTER] is pressed, the instruction or data displayed in the input buffer line moves to the cursor position to complete a registration, insertion, or modification.</p>

<p>[SHIFT]</p> 	<p>Changes the functions of other keys by pressing together. Can be used with [MAIN MENU], [COORD], [MOTION TYPE], cursor key, Numeric key, page key  to access alternate functions. Refer to the description of each key for the alternate [SHIFT] functions.</p>
<p>[INTERLOCK]</p> 	<p>Changes the functions of other keys by pressing together. Can be used with [TEST START], [FWD], Numeric key (Numeric key customize function). Refer to the description of each key for the alternate [INTERLOCK] functions.</p>
<p>Numeric Key</p> 	<p>Enters the number or symbol when the ">" prompt appears on the input line. "." is the decimal point. "-" is a minus sign or hyphen. The Numeric keys are also used as function keys. Refer to the explanation of each function for details.</p>
<p>[START]</p>  <p>START</p>	<p>Starts the manipulator motion in playback operation. The lamp on this button is lit during the playback operation. The lamp also lights when the playback operation is started by the system input START signal. The lamp turns OFF when the playback operation is stopped by alarm occurrence, HOLD signal, or mode change.</p>
<p>[HOLD]</p>  <p>HOLD</p>	<p>Holds the manipulator motion. This button is enabled in any mode. The lamp on this button is lit only while the button is being pressed. Although the lamp turns OFF when the button is released, the manipulator stays stopped until a START command is input. The HOLD lamp automatically lights in the following cases to indicate that the system is in HOLD status. The start and axis operations are disabled while the lamp is lit.</p> <ul style="list-style-type: none"> • The HOLD signal of system input is ON. • The HOLD request is being sent from an external device in remote mode. • In HOLD status caused by an error occurred in working process such as wire sticking at arc welding
<p>Mode Switch</p> 	<p>Selects the Play mode, Teach mode, or Remote mode.</p> <p>PLAY: Play Mode The playback of taught job is enabled. The START signal from an external device is disabled.</p> <p>TEACH: Teach Mode The axis operation and edition from the programming pendant are enabled. The START signal from an external device is disabled.</p> <p>REMOTE: Remote Mode The operation by external signals is enabled. [START] is invalid during the remote mode.</p>

<p>[MAIN MENU]</p> 	<p>Displays the main menu.</p> <p>If this button is pressed while the main menu is displayed, the main menu disappears.</p> <p>[SHIFT] + [MAIN MENU]</p> <p>While a window opens, the window is switched in the following order: Window → Sub-menu → Main menu</p>
<p>[SERVO ON READY]</p> 	<p>Enables the servo power supply to be turned ON.</p> <p>Press this button to enable the servo power supply to be turned ON if the servo power supply is shut OFF by the emergency stop or overrun signal. When this button is pressed:</p> <ul style="list-style-type: none"> • In the play mode, the servo power supply is turned ON if the safeguarding is securely closed. • In the teach mode, the SERVO ON lamp flashes and the servo power supply is turned ON when the Enable switch is ON. • The SERVO ON lamp is lit while the servo power is ON.
<p>[ASSIST]</p> 	<p>Displays the menu to assist the operation for the currently displayed window.</p> <p>Pressing this button with [SHIFT] or [INTERLOCK] displays the help guidance for the operation.</p> <ul style="list-style-type: none"> • [SHIFT] + [ASSIST] The function list of key combinations with [SHIFT] appears. • [INTERLOCK] + [ASSIST] The function list of key combinations with [INTERLOCK] appears.
<p>[BACK SPACE]</p> 	<p>Deletes the last character while typing characters.</p>

1.2.4 Programming Pendant Display

■ The Five Display Areas

The programming pendant display is a 6.5 inch color display. Alphanumeric characters can be used.

The general display area, menu area, human interface display area, and main menu area among the following five areas can be moved by pressing [AREA], or can be selected by directly touching the screen.

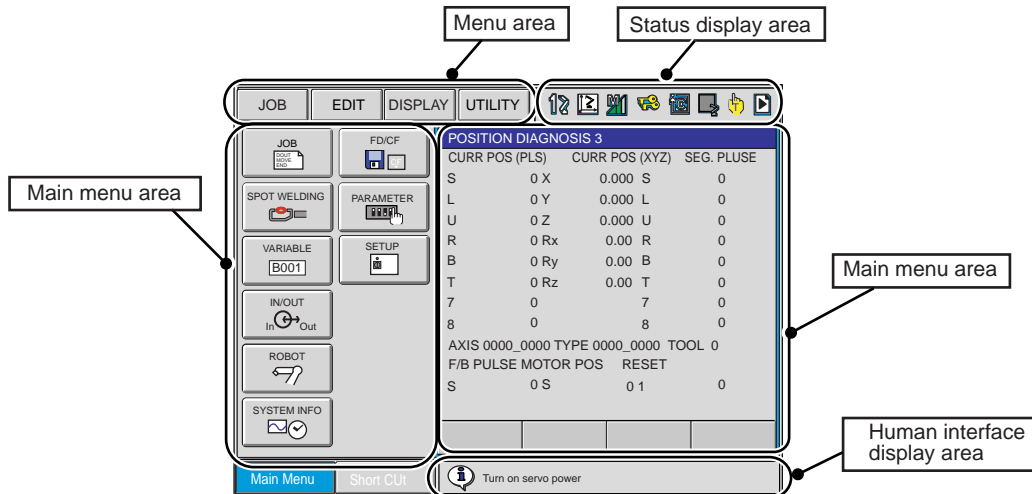

Each window displayed during operations is provided with its name on the upper left of the general display area.

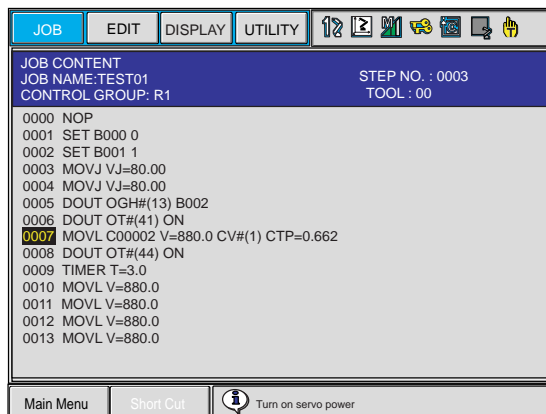

■ General-purpose Display Area

On the general-purpose display area, various settings and contents such as jobs and characteristics files can be displayed and edited.

The operation buttons are also displayed at the bottom of the window according to the window contents.

- To move the cursor to the operation button, press [AREA] + DOWN cursor key.
- To move the cursor to the general-purpose display area, press [AREA] + UP cursor key or press [CANCEL].
- To move the cursor between the operation buttons, use the RIGHT or LEFT cursor key.
- To execute the operation button, move the cursor to the button and press [SELECT].

EXECUTE: Continues operation with the displayed contents.

CANCEL: Cancels the displayed contents and returns to the previous window.

COMPLETE: Completes the setting operation displayed on the general-purpose display area.

STOP: Stops operation when loading, saving, or verifying with an external memory device.

RELEASE: Releases the overrun and shock sensor function.

RESET: Resets an alarm. (Cannot reset major alarms.)

DIRECT PAGE: Jumps to the appropriate page if the page can be switched.

- When the page can be switched by specifying the page number, the following input box appears when "DIRECT PAGE" is selected. Directly type the desired page number and press [ENTER].

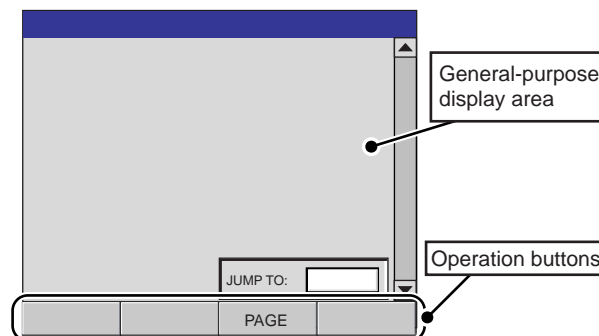

- When the page can be switched by selecting an item, the following selection list appears when "DIRECT PAGE" is selected. Select a desired item using the UP and DOWN cursor key and press [ENTER].

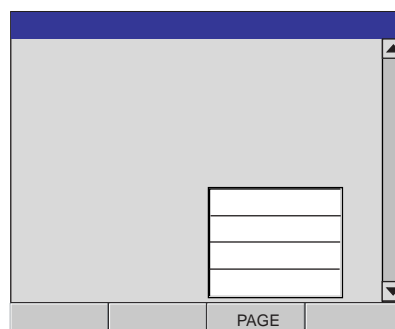

■ Main Menu Area

Each menu and submenu are displayed in the main menu area. Press [MAIN MENU] or touch {Main Menu} on the left bottom of the window to display the main menu.

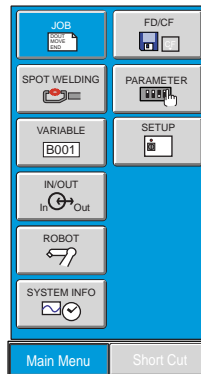

■ Status Display Area

The Status Display area shows controller status. The displayed information will vary depending on the controller mode (Play/Teach).

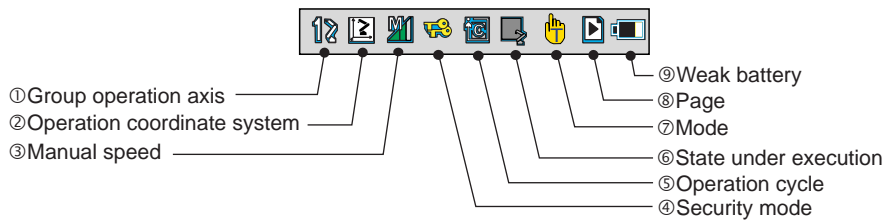

① Control Group

Displays the active control group for systems equipped with station axes or several robot axes.

to : Robot Axes

to : Base Axes

to : Station Axes

② Operation Coordinate System

Displays the selected coordinate system. Switched by pressing [COORD].

: Joint Coordinates

: Cartesian Coordinates

: Cylindrical Coordinates

: Tool Coordinates

: User Coordinates

③ Manual Speed

Displays the selected speed. For details, refer to “■ Select Manual Speed.”

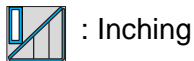

: Inching



: Low Speed



: Medium Speed



: High Speed

④ Security Mode

: Operation Mode



: Edit Mode



: Management Mode

⑤ Operation Cycle

Displays the present operation cycle.



: Step



: Cycle



: Continuous

⑥ State Under Execution

Displays the present system status (STOP, HOLD, ESTOP, ALARM, or RUN).



: Stop Status



: Hold Status



: Emergency Stop Status



: Alarm Status



: Operating Status

⑦ Mode (NS3.00 or later)

: Teach mode



: Play mode

⑧ Page

: Displayed when the page can be switched.

⑨ Weak Battery of Memory

: Displayed when the battery of memory is weak.

■ Human Interface Display Area

When two or more errors or messages are displayed,  appears in the human interface display area.

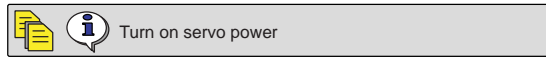

To view the list of current errors or messages, activate the human interface display area and press [SELECT]. To close the error list, press [CANCEL].

When two or more errors occur,  appears in the message display area. Activate the message display area and press [SELECT] to view the list of current errors.

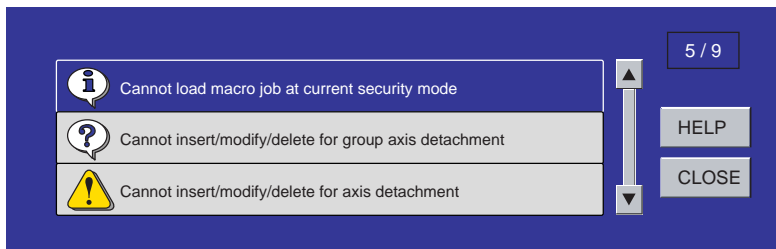

To close the error list, select "CLOSE" or press [CANCEL].

■ Menu Area

The menu area is used to edit a job, manage jobs, and execute various utilities.



1.2.5 Screen Descriptions

■ Denotation

The menu displayed in the programming pendant is denoted with { }.



The above menu items are denoted with {DATA}, {EDIT}, {DISPLAY}, AND {UTILITY}.

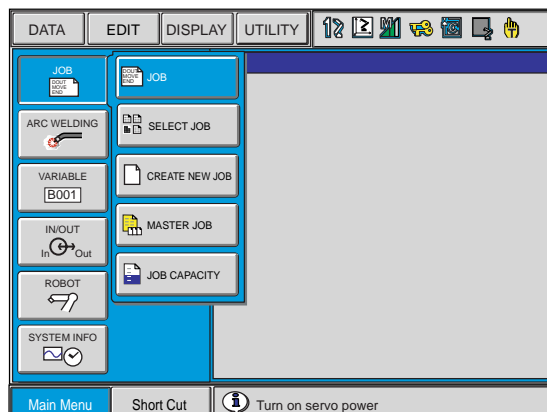

The pull-down menu commands are denoted in the same manner.

■ Screen

The window can be displayed according to the view desired.

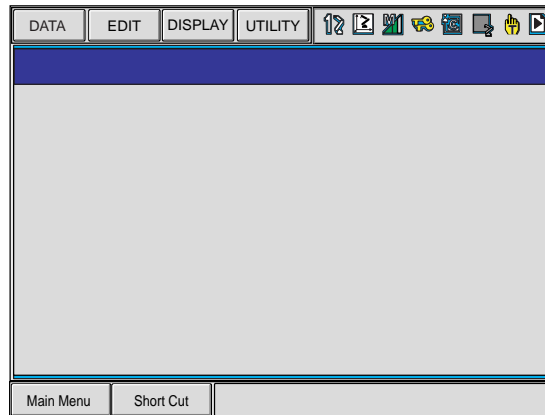

Full Window View

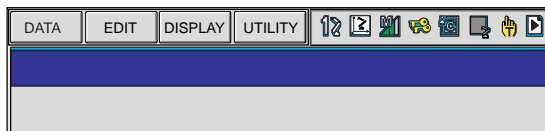

Upper Window View

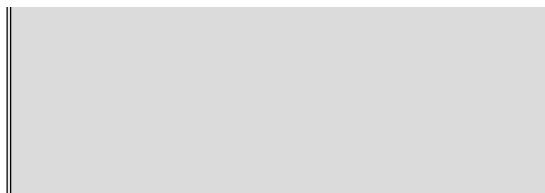

Middle Window View











Lower Window View

1.2.6 Character Input

To input characters, display the software keypad on the programming pendant display. Move the cursor to the data for which characters are to be input, and press [SELECT] to display the software keypad.

There are three types of software keypads: the alphanumeric keypads each for upper-case and lower-case characters and the symbol keypad. To switch between the alphanumeric keypads and the symbol keypad, touch the button tab on the screen or press [PAGE]. To switch the alphanumeric keypads between upper-case and lower-case characters, touch "CapsLock OFF" or "CapsLock ON."

■ Operation

Keypad	Button on the Programming Pendant	Explanation
Cursor		Moves the cursor (focus).
[SELECT]		Selects a character.
[CANCEL]		Clears all the characters being typed. Pressing this second time cancels the software keypad.
[BACK SPACE]		Deletes the last one character.
[ENTER]		Enters the input characters.
Button Tab		Switches the keypads displayed on the programming pendant.
		Closes the software keypad.
Numeric Keys	 to 	Enters numbers.

■ Alphanumeric Input

Number input is performed with the Numeric keys or on the following alphanumeric input window. Numbers include 0 to 9, the decimal point (.), and the minus sign/hyphen (-).

Note however, that the decimal point cannot be used in job names.

Press the page key  to display the alphanumeric input window. Move the cursor to the desired letter and press [SELECT] to enter the letter.

For Numbers and Upper-case Characters

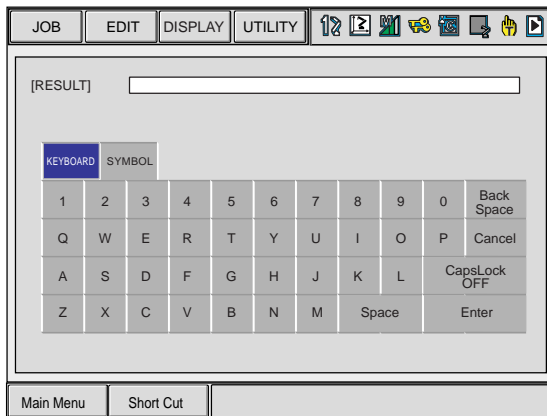

For Numbers and Lower-case Characters

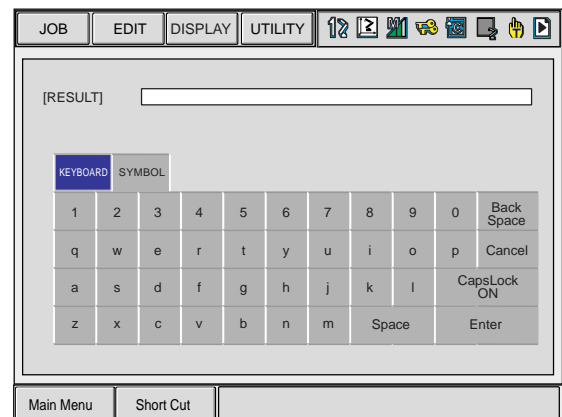

■ Symbol Input

Press the page key  to display the symbol input window.

Move the cursor to the desired symbol and press [SELECT] to enter the symbol.

Note that only some symbols are available for naming jobs.

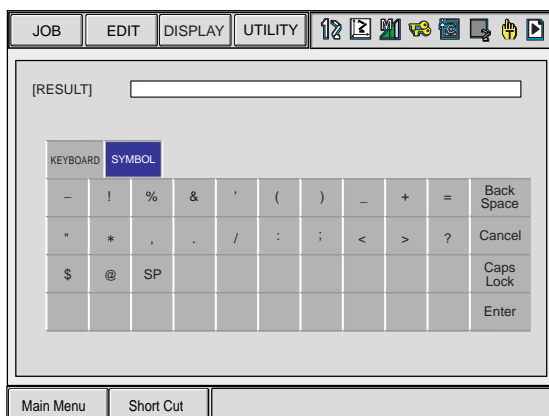

SP: Space

1.3 Modes

The following three modes are available for NX100.

- Teach Mode
- Play Mode
- Remote Mode

1.3.1 Teach Mode

In the teach mode, the following can be done.

- Preparation and teaching of a job
- Modification of a registered job
- Setting of various characteristic files and parameters

1.3.2 Play Mode

In the play mode, the following can be done.

- Playback of a taught job
- Setting, modification, or deletion of various condition files

1.3.3 Remote Mode

In the remote mode, the operations such as Servo ON Ready, Start, Cycle Change, Call Master Job can be commanded by external input signals.

The operations by external input signals become enabled in the remote mode, while [START] on the programming pendant becomes disabled.

The data transmission function (optional function) is also available in the remote mode.

The following table shows how each operation is input in each mode.

Note: "PP" indicates the programming pendant.

	Teach Mode	Play Mode	Remote Mode
Servo ON Ready	PP	PP	External input signal
Start	Invalid	PP	External input signal
Cycle Change	PP	PP	External input signal
Call Master Job	PP	PP	External input signal

1.3.4 Teach Mode Priority

In the teach mode, following operations are disabled:

- 1) Playback using [START].
- 2) Playback from external input signals.

1.4 About the Security Mode

1.4.1 Types of Security Modes

The following three types of security modes are available for NX100.

Any operations in the edit mode and the management mode require a password. The password must contain between 4 and 8 letters, numbers, or symbols.

- **Operation Mode**

The operator can monitor the line operation and start and stop the manipulator. Repairs, etc. can be performed if any abnormalities are detected.

- **Edit Mode**

Teaching, robot jog operations, and editing of jobs and various condition files can be performed in addition to the operations enabled in the operation mode.

- **Management Mode**

The operator who performs setup and maintenance for the system can set the machine control parameter, set the time, change the password, etc. in addition to the operations enabled in the edit mode.

1.4 About the Security Mode

Menu & Security Mode

Main Menu	Sub Menu	Security Mode	
		DISPLAY	EDIT
JOB	JOB	Operation	Edit
	SELECT JOB	Operation	Operation
	CREATE NEW JOB ^{*1}	Edit	Edit
	MASTER JOB	Operation	Edit
	JOB CAPACITY	Operation	-
	RES. START(JOB) ^{*1}	Edit	Edit
	RES. STATUS ^{*2}	Operation	-
	CYCLE	Operation	Operation
VARIABLE	BYTE	Operation	Edit
	INTEGER	Operation	Edit
	DOUBLE	Operation	Edit
	REAL	Operation	Edit
	STRING	Operation	Edit
	POSITION(ROBOT)	Operation	Edit
	POSITION(BASE)	Operation	Edit
	POSITION(ST)	Operation	Edit
	LOCAL VARIABLE	Operation	-
IN/OUT	EXTERNAL INPUT	Operation	-
	EXTERNAL OUTPUT	Operation	-
	UNIVERSAL INPUT	Operation	-
	UNIVERSAL OUTPUT	Operation	Edit
	SPECIFIC INPUT	Operation	-
	SPECIFIC OUTPUT	Operation	-
	RIN	Operation	-
	CPRIN	Operation	-
	REGISTER	Operation	-
	AUXILIARY RELAY	Operation	-
	CONTROL INPUT	Operation	-
	PSEUDO INPUT SIG	Operation	Management
	NETWORK INPUT	Operation	-
	NETWORK OUTPUT	Operation	-
	ANALOG OUTPUT	Operation	-
	SV POWER STATUS	Operation	-
	LADDER PROGRAM	Management	Management
	I/O ALARM	Management	Management
I/O MESSAGE	Management	Management	

^{*1} Displayed in the teach mode only.

^{*2} Displayed in the play mode only.

Menu & Security Mode

Main Menu	Sub Menu	Security Mode	
		DISPLAY	EDIT
ROBOT	CURRENT POSITION	Operation	-
	COMMAND POSITION	Operation	-
	SERVO MONITOR	Management	-
	WORK HOME POS	Operation	Edit
	SECOND HOME POS	Operation	Edit
	DROP AMOUNT	Management	Management
	POWER ON/OFF POS	Operation	-
	TOOL	Edit	Edit
	INTERFERENCE	Management	Management
	SHOCK SENS LEVEL	Operation	Management
	USER COORDINATE	Edit	Edit
	HOME POSITION	Management	Management
	MANIPULATOR TYPE	Management	-
	ROBOT CALIB	Edit	Edit
	ANALOG MONITOR	Management	Management
	OVERRUN&S-SENSOR ^{*1}	Edit	Edit
	LIMIT RELEASE ^{*1}	Edit	Management
	ARM CONTROL ^{*1}	Management	Management
	SHIFT VALUE	Operation	-
SYSTEM INFO	VERSION	Operation	-
	MONITORING TIME	Operation	Management
	ALARM HISTORY	Operation	Management
	I/O MSG HISTORY	Operation	Management
	SECURITY	Operation	Operation
FD/CF	LOAD	Edit	-
	SAVE	Operation	-
	VERIFY	Operation	-
	DELETE	Operation	-
	DEVICE	Operation	Operation
	FOLDER	Edit	Edit
	FORMAT ^{*5}	Operation	Operation

^{*1} Displayed in the teach mode only.

^{*5} For FC1/FC2 Floppy disk

1.4 About the Security Mode

Menu & Security Mode

Main Menu	Sub Menu	Security Mode	
		DISPLAY	EDIT
PARAMETER	S1CxG	Management	Management
	S2C	Management	Management
	S3C	Management	Management
	S4C	Management	Management
	A1P	Management	Management
	A2P	Management	Management
	A3P	Management	Management
	A4P	Management	Management
	RS	Management	Management
	S1E	Management	Management
	S2E	Management	Management
	S3E	Management	Management
	S4E	Management	Management
SETUP	TEACHING COND	Edit	Edit
	OPERATE COND	Management	Management
	DATE/TIME	Management	Management
	GRP COMBINATION	Management	Management
	RESERVE JOB NAME	Edit	Edit
	USER ID	Edit	Edit
	SET SPEED	Management	Management
	KEY ALLOCATION ^{*1}	Management	Management
	RES. START(CNCT)	Management	Management
	AUTO BACKUP SET ^{*3}	Management	Management
	WRONG DATA LOG ^{*4}	Operation	Management
ARC WELDING	ARC START COND.	Operation	Edit
	ARC END COND.	Operation	Edit
	ARC AUX COND.	Operation	Edit
	POWER SOURCE COND.	Operation	Edit
	ARC WELD DIAG.	Operation	Edit
	WEAVING	Operation	Edit
	ARC MONITOR	Operation	-
HANDLING	HANDLING DIAG.	Operation	Edit
SPOT WELDING	WELD DIAGNOSIS	Operation	Edit
	I/O ALLOCATION	Management	Management
	GUN CONDITION	Management	Management
	SPOT POWER SOURCE COND.	Management	Management

^{*1} Displayed in the teach mode only.

^{*3} From NS3.20

^{*4} From NS3.21

Menu & Security Mode

Main Menu	Sub Menu	Security Mode	
		DISPLAY	EDIT
SPOT WELDING (MOTOR GUN)	WELD DIAGNOSIS	Operation	Edit
	GUN PRESSURE	Edit	Edit
	PRESSURE	Edit	Edit
	I/O ALLOCATION	Management	Management
	GUN CONDITION	Management	Management
	CLEARANCE SETTING	Operation	Edit
	SPOT POWER SOURCE COND.	Management	Management
GENERAL	WEAVING	Operation	Edit
	GENERAL DIAGNOSIS	Operation	Edit
ALL COMMON APPLICATION	I/O-VARIABLE CUSTOMIZE	Operation	Operation

1.4.2 Switching Security Modes

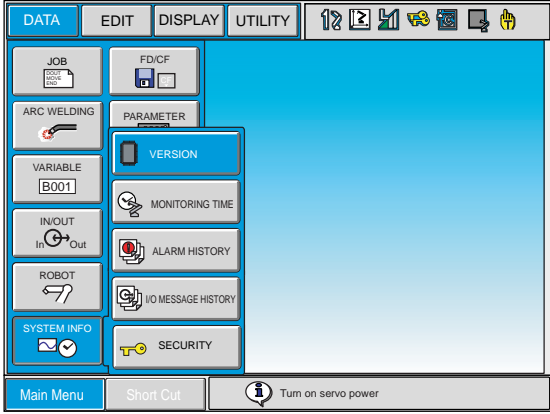
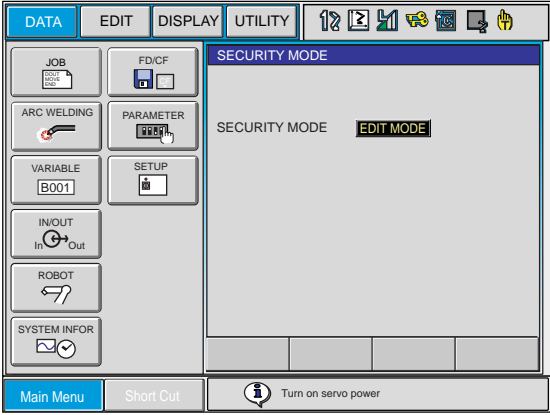
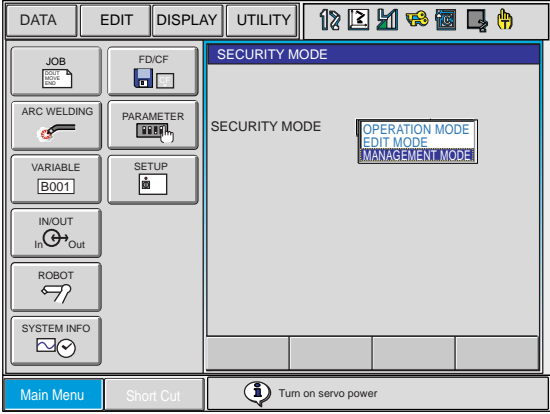
	Operation	Explanation
1	Select {SYSTEM INFO} under the main menu.	<p>The sub menu appears.</p>  <p>The screenshot shows a control panel interface with a top navigation bar containing 'DATA', 'EDIT', 'DISPLAY', and 'UTILITY'. Below this is a grid of menu items including 'JOB', 'ARC WELDING', 'VARIABLE', 'IN/OUT', 'ROBOT', 'SYSTEM INFO', 'FD/CF', 'PARAMETER', 'VERSION', 'MONITORING TIME', 'ALARM HISTORY', and 'I/O MESSAGE HISTORY'. The 'SYSTEM INFO' item is highlighted with a blue border. At the bottom, there are buttons for 'Main Menu', 'Short Cut', and a 'Turn on servo power' indicator.</p>
2	Select {SECURITY}.	 <p>The screenshot shows the 'SECURITY MODE' menu. The 'SECURITY MODE' title is at the top. Below it, the text 'SECURITY MODE' is displayed next to a highlighted 'EDIT MODE' button. The rest of the interface, including the top navigation bar and bottom buttons, remains the same as in the previous screenshot.</p> <p>The security mode can be selected from operation mode, edit mode, or management mode.</p>  <p>The screenshot shows the 'Security Mode Selection Dialog Box'. It features a list of three options: 'OPERATION MODE', 'EDIT MODE', and 'MANAGEMENT MODE'. The 'OPERATION MODE' option is currently selected and highlighted with a blue border. The background of the dialog box is a light gray color.</p> <p style="text-align: center;">Security Mode Selection Dialog Box</p>
3	Select the desired security mode.	When the selected security mode is higher than the currently set mode, the user ID input status window appears.

	Operation	Explanation
4	Input user ID as required.	At the factory, the user ID number is preset as follows: <ul style="list-style-type: none">• Edit Mode: [00000000]• Management Mode: [99999999]
5	Press [ENTER].	The selected security mode's input ID is checked. If the correct user ID is input, the security mode is changed.

2 Manipulator Coordinate Systems and Operations

2.1 Control Groups and Coordinate Systems

2.1.1 Control Group

For the NX100, a group of axes to be controlled at a time is called “Control Group”, and the group is classified into three units: “ROBOT” as a manipulator itself, “BASE” that moves the manipulator in parallel, and “STATION” as jigs or tools other than “ROBOT” and “BASE”. BASE and STATION are also called external axes.

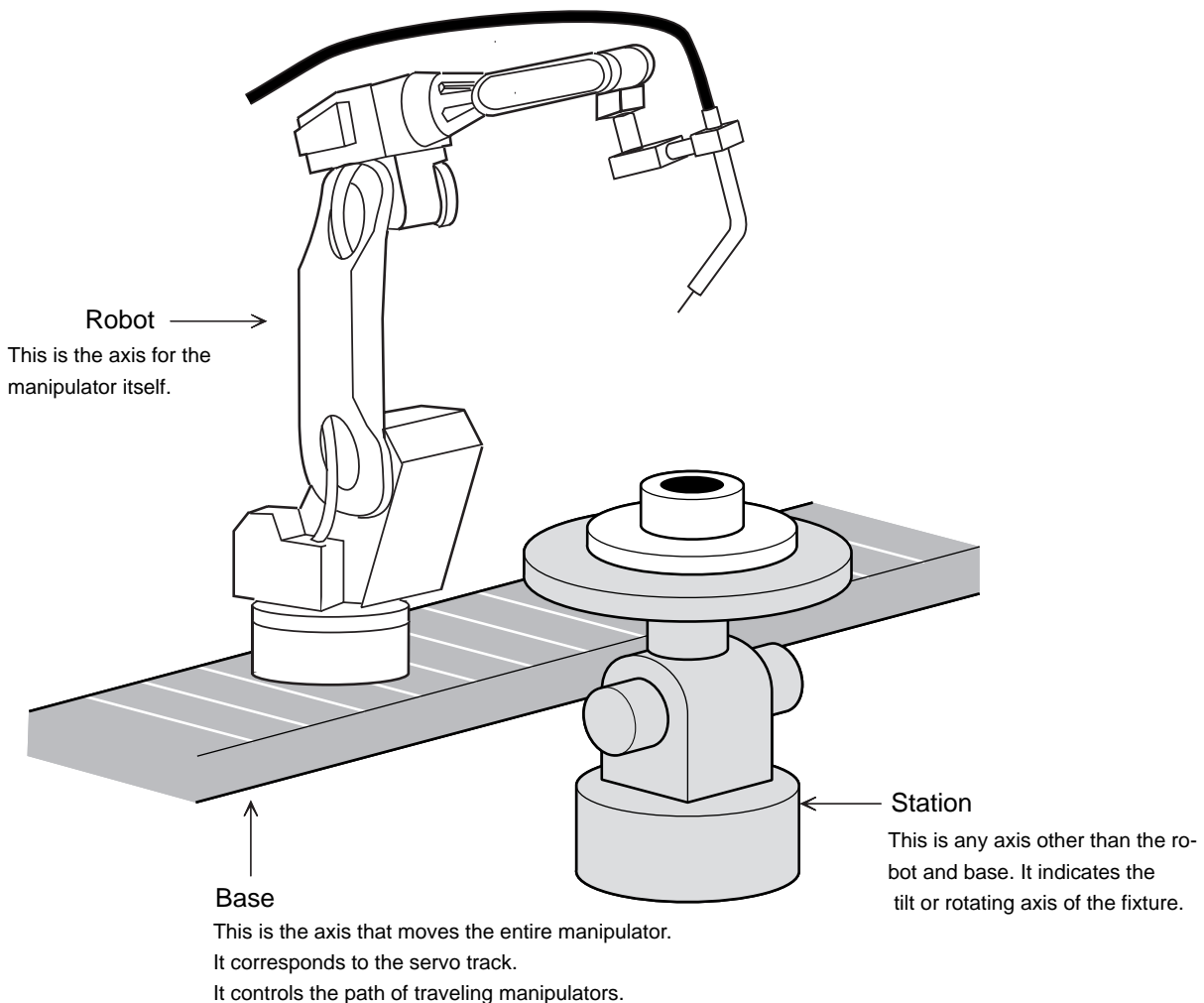

2.1.2 Types of Coordinate Systems

The following coordinate systems can be used to operate the manipulator:

- **Joint Coordinates**
Each axis of the manipulator moves independently.
- **Cartesian Coordinates**
The tool tip of the manipulator moves parallel to any of the X-, Y-, and Z-axes.
- **Cylindrical Coordinates**
The θ axis moves around the S-axis. The R-axis moves parallel to the L-axis arm. For vertical motion, the tool tip of the manipulator moves parallel to the Z-axis.
- **Tool Coordinates**
The effective direction of the tool mounted in the wrist flange of the manipulator is defined as the Z-axis. This axis controls the coordinates of the end point of the tool.
- **User Coordinates**
The XYZ-cartesian coordinates are defined at any point and angle. The tool tip of the manipulator moves parallel to the axes of them.

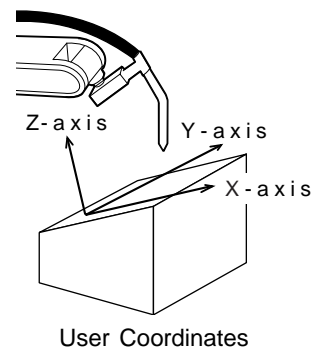
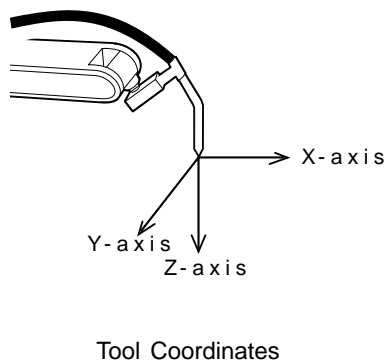
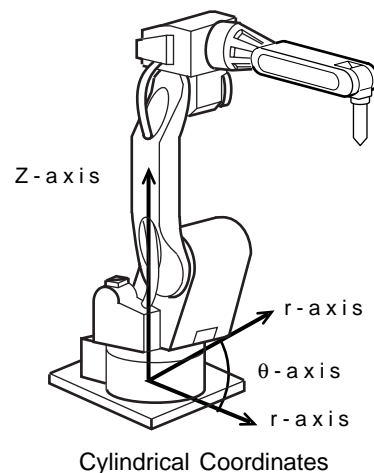
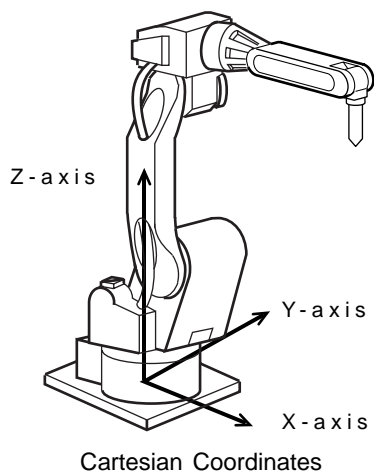

2.2 General Operations

■ Check Safety

Before any operation of NX100, read Section 1 “Safety” of “NX100 INSTRUCTIONS” again and keep safe around robot system or peripherals.

■ Select Teach Mode

Set the mode switch on the programming pendant to “teach”.

■ Select Control Group

If NX100 has several Control Groups or Coordinate Control Systems (optional function), select control group first.

If two or more ROBOT, BASE, STATION are registered, switch control group by pressing [SHIFT] + [ROBOT] or [SHIFT] + [EX. AXIS].

After selecting a job, a control group registered in the selected job is enabled. A control group registered in the edit job can be switched by pressing [ROBOT] or [EX. AXIS].

Check selected control group at status display area on the programming pendant.

■ Select Coordinate System

Select coordinate system by pressing [COORD] button.

It switches; Joint→Cartesian (Cylindrical)→Tool→User in every pressing. Check the selected coordinate on the status display area on the programming pendant.

■ Select Manual Speed

Select manual speed of operation by pressing [FAST] or [SLOW]. The selected speed is effective not only for axis operation but [FWD] or [BWD] operation.

NOTE In operating the manipulator manually by the programming pendant, the maximum speed of center point is limited at 250 mm/s.

- Every press of [FAST] switches; “INCH”→”SLOW”→”MED”→”FAST”.



- Every press of [SLOW] switches; “FAST”→”MED”→”SLOW”→”INCH”.



Check selected manual speed on the status area of Programming Pendant.

■ Servo ON

Press [SERVO ON READY], then SERVO ON LED starts blinking.
Squeeze the Enable switch, then SERVO ON LED starts lighting.

■ Axis Operation

Make sure of safety around the manipulator. Press axis key, then axis moves according to the selected control group, coordinates, and manual speed. See " 2.3 Coordinate Systems and Axis Operation " for details.

■ HIGH SPEED

Pressing of [HIGH SPEED] with axis keys pressed allows the manipulator to move faster than usual speed.









The [HIGH SPEED] key is disabled when "INCH" is selected for manual speed.

2.3 Coordinate Systems and Axis Operation

2.3.1 Joint Coordinates

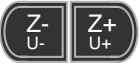
When operating in joint coordinates mode, the S, L, U, R, B, and T-axes of the manipulator move independently. The motion of each axis is described in the table below.

Axis Motion in Joint Coordinates

Axis Name		Axis Operation Key	Motion
Major Axes	S-axis		Main unit rotates right and left.
	L-axis		Lower arm moves forward and backward.
	U-axis		Upper arm moves up and down.
Wrist Axes	R-axis		Wrist rolls right and left.
	B-axis		Wrist moves up and down.
	T-axis		Wrist turns right and left.



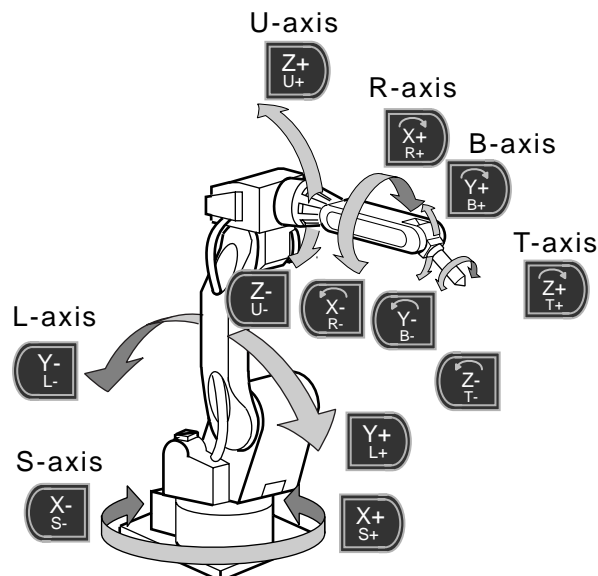

- When two or more axis keys are pressed at the same time, the manipulator will perform a compound movement. However, if two different directional keys for the same axis are pressed at the same time (such as [S-] + [S+]), none of the axes operate.
- When using a manipulator of 7 axes or 8 axes, the C-axis (7th axis) is moved by pressing [SHIFT] + [S-] or [SHIFT] + [S+]; the W-axis (8th axis) by pressing [SHIFT] + [L-] or [SHIFT] + [L+].



2.3.2 Cartesian Coordinates

In the cartesian coordinates, the manipulator moves parallel to the X-, Y-, or Z-axes. The motion of each axis is described in the following table:

Axis Motion in Cartesian Coordinates

Axis Name	Axis Operation Key	Motion
Basic Axes	X-axis 	Moves parallel to X-axis.
	Y-axis 	Moves parallel to Y-axis.
	Z-axis 	Moves parallel to Z-axis.
Wrist Axes	Motion about TCP is executed. See " 2.3.7 Control Point Operation " and " 2.3.8 Control Point Change. "	



When two or more axis keys are pressed at the same time, the manipulator will perform compound movement. However, if two different directional keys for the same axis are pressed at the same time (such as [X-] + [X+]), none of the axes operate.

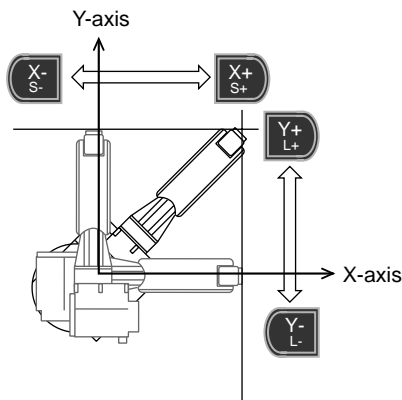
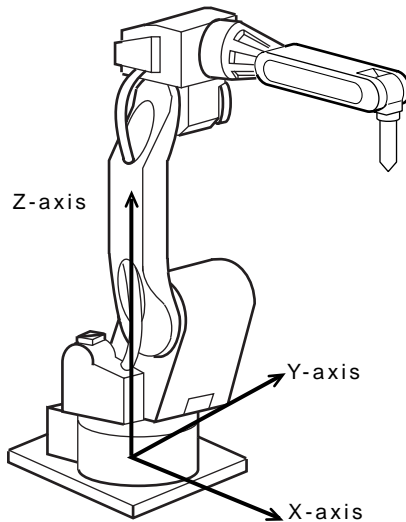

Moves parallel to X- or Y-axis

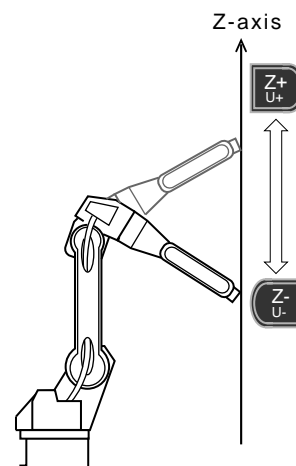



Moves parallel to Z-axis

2.3.3 Cylindrical Coordinates

In the cylindrical coordinates, the manipulator moves as follows. The motion of each axis is described in the following table.

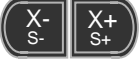
Axis Motion in Cylindrical Coordinates

Axis Name	Axis Operation Key	Motion
Basic Axes	θ -axis 	Main unit rolls around S-axis.
	r-axis 	Moves perpendicular to Z-axis.
	Z-axis 	Moves parallel to Z-axis.
Wrist Axes	Motion about TCP is executed. See " 2.3.7 Control Point Operation " and " 2.3.8 Control Point Change ".	



When two or more axis keys are pressed at the same time, the manipulator will perform compound movement. However, if two different directional keys for the same axis are pressed at the same time (such as [Z-] + [Z+]), none of the axes operate.

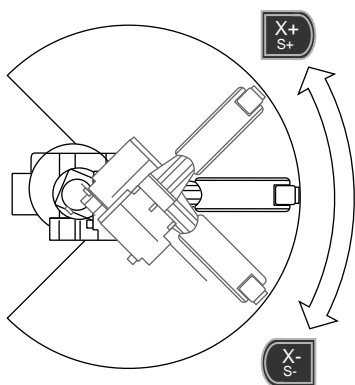
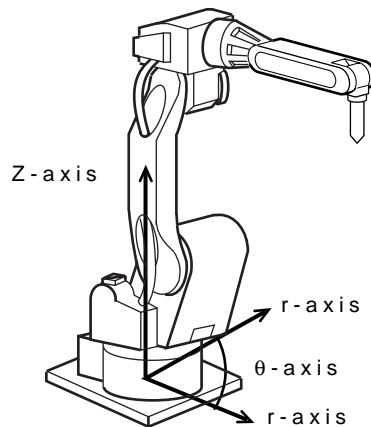

Rolls around θ -axis

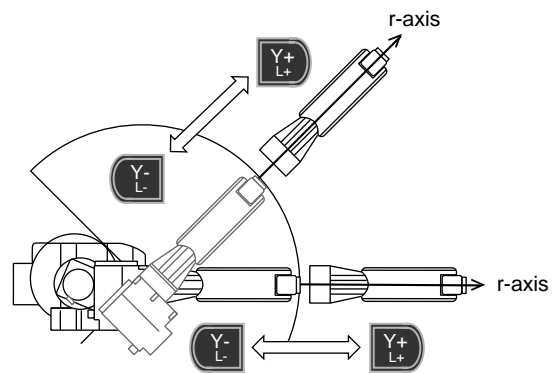



Moves perpendicular to r-axis

2.3.4 Tool Coordinates

In the tool coordinates, the manipulator moves parallel to the X-, Y-, and Z-axes, which are defined at the tip of the tool. The motion of each axis is shown in the following table:

Axis Motion in Tool Coordinates

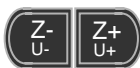
Axis Name		Axis Operation Key	Motion
Basic Axes	X- axis		Moves parallel to X-axis.
	Y- axis		Moves parallel to Y-axis.
	Z- axis		Moves parallel to Z-axis.
Wrist Axes		Motion about TCP is executed. See " 2.3.7 Control Point Operation " and " 2.3.8 Control Point Change ".	



When two or more axis keys are pressed at the same time, the manipulator will perform compound movement. However, if two different directional keys for the same axis are pressed at the same time (such as [X-] + [X+]), none of the axes operate.

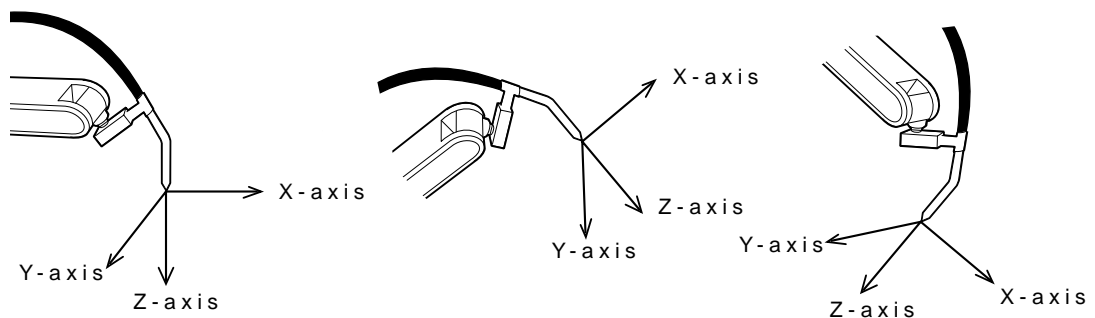

The tool coordinates are defined at the tip of the tool, assuming that the effective direction of the tool mounted on the manipulator wrist flange is the Z-axis. Therefore, the tool coordinates axis direction moves with the wrist.

In tool coordinates motion, the manipulator can be moved using the effective tool direction as a reference regardless of the manipulator position or orientation. These motions are best suited when the manipulator is required to move parallel while maintaining the tool orientation with the workpieces.

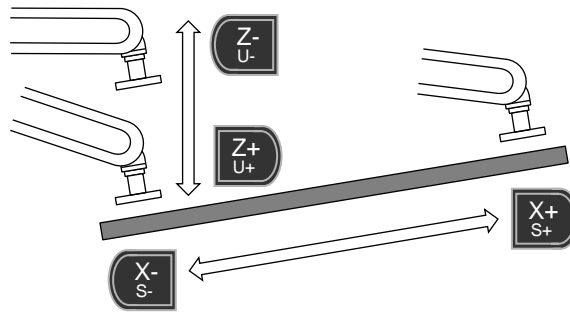

For tool coordinates, the tool file should be registered in advance. For further details, refer to “8.3 Tool Data Setting” of coordinates “NX100 INSTRUCTIONS” (RE-CTO-A211).

■ Selecting the Tool

Tool numbers are used to specify a tool when more than one tool is used on the system. You may select from registered tool files when you switch tools on the manipulator.



This operation can be performed only when numbers of the tool is more than one. To use several tool files with one manipulator, set the following parameter.
 S2C333: Tool number switch specifying parameter
 1: Can be switched
 0: Cannot be switched

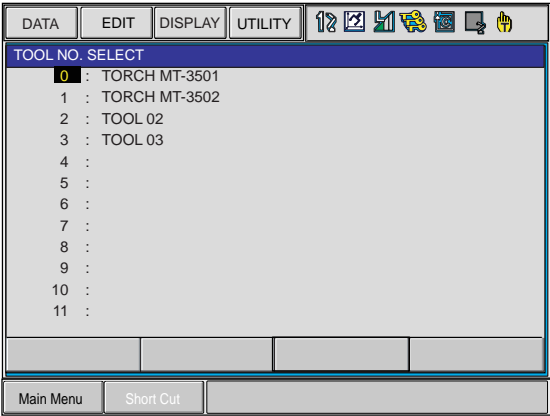

	Operation	Explanation
1	Press the [COORD] key and select the tool coordinates  .	Every pressing of the [COORD] key changes coordinate system; Joint→Cartesian (Cylindrical)→Tool→User. Check the change on the status display area.
2	Press [SHIFT] + [COORD].	The TOOL NO. SELECT window appears. 
3	Move the cursor to the tool to use.	The TOOL NO. SELECT window above shows an example; “TOOL NO. 0 TORCH MT-3501” is selected.
4	Press [SHIFT] + [COORD].	The window goes back to the previous window.

2.3.5 User Coordinates

In the user coordinates, the manipulator moves parallel to each axis of the coordinates which are set by the user. Up to 24 coordinate types can be registered. Each coordinate has a user number and is called a user coordinate file. The motion of each axis is described in the following table:

The figure and the table below describe the motion of each axis when the axis key is pressed.

Axis Motion in User Coordinates

Axis Name		Axis Key	Motion
Basic Axes	X- axis		Moves parallel to X-axis.
	Y- axis		Moves parallel to Y-axis.
	Z- axis		Moves parallel to Z-axis.
Wrist Axes		Motion about TCP is executed. See " 2.3.7 Control Point Operation " and " 2.3.8 Control Point Change ".	



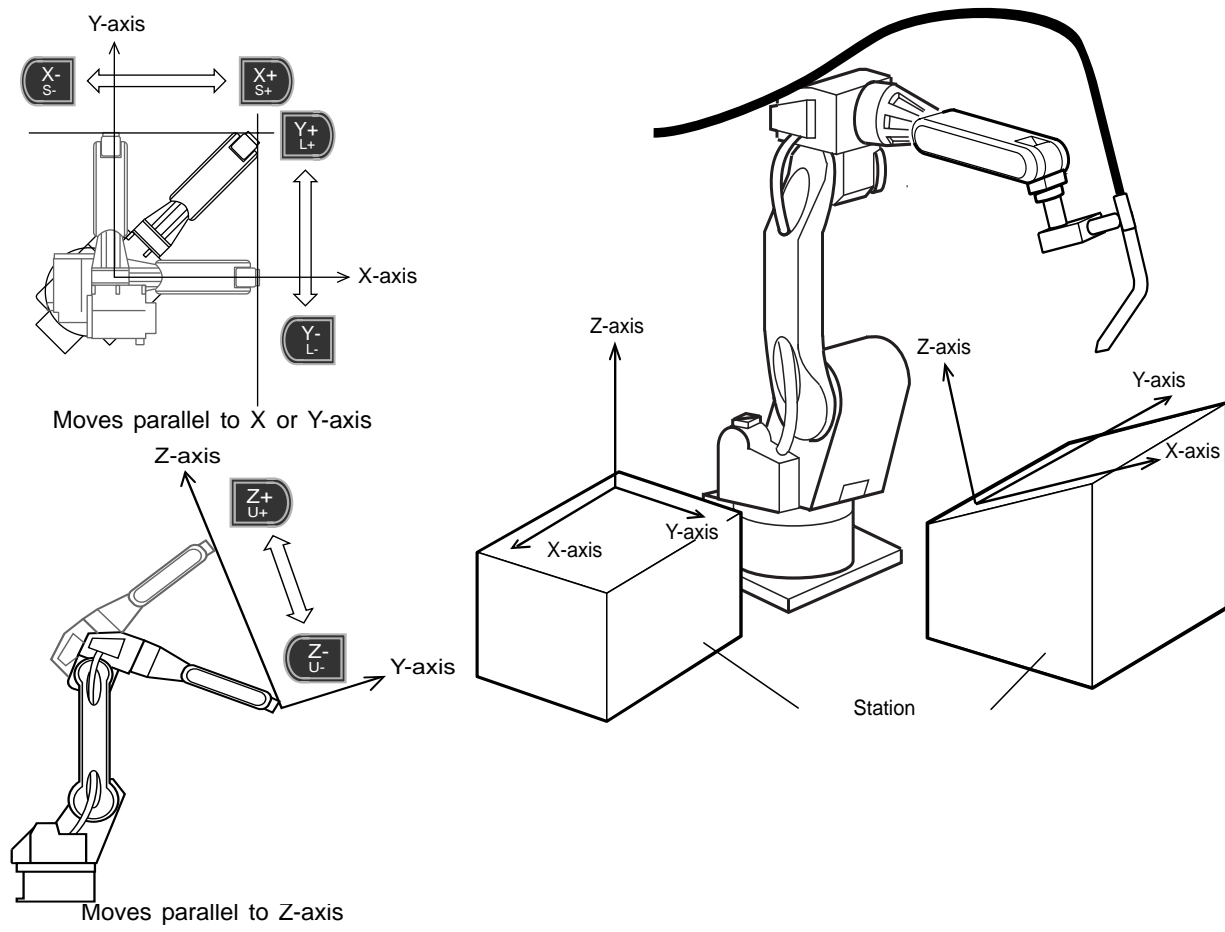

When two or more axis keys are pressed at the same time, the manipulator will perform compound movement. However, if two different directional keys for the same axis are pressed at the same time (such as [X-] + [X+]), none of the axes operate.

2.3 Coordinate Systems and Axis Operation

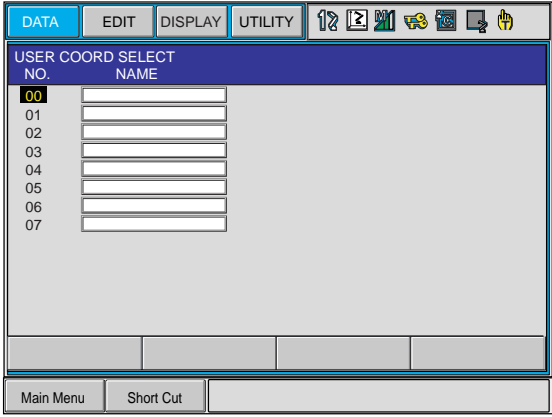

■ Selecting User Coordinates

Follow these procedures to select the desired coordinate system from among the registered user coordinates.

	Operation	Explanation
1	Press [COORD] to select the user coordinates  .	Every pressing of the [COORD] key changes coordinate system; Joint→Cartesian (Cylindrical)→Tool→User. Check the change on the status display area.
2	Press [SHIFT] + [COORD].	<p>The USER COORD SELECT window appears.</p>  <div style="border: 1px solid black; padding: 5px; margin-top: 10px;">  For more information on registration of the user coordinates, refer to “8.8 User Coordinate Setting” of “NX100 INSTRUCTIONS” (RE-CTO-A211). </div>
3	Select the desired user number.	

■ Examples of User Coordinate Utilization

The user coordinate settings allow easy teaching in various situations. For example:

- When multiple positioners are used, manual operation can be simplified by setting the user coordinates for each fixture.

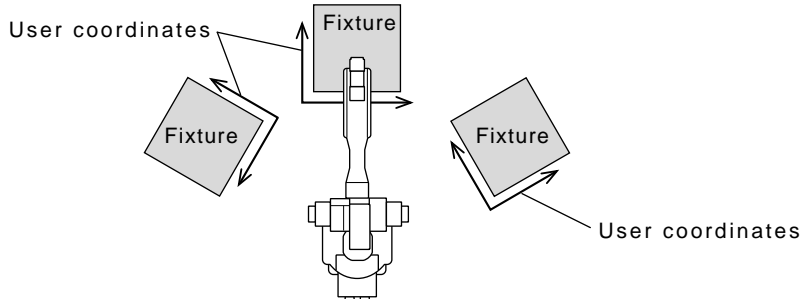

- When performing arranging or stacking operations, the incremental value for shift can be easily programmed by setting user coordinates on a pallet.

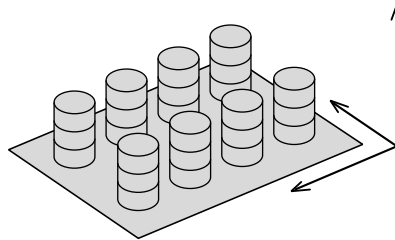

- When performing conveyor tracking operations, the moving direction of the conveyor is specified.

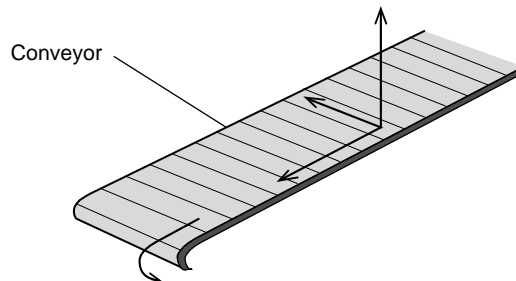







2.3.6 External Axis

External axis is enabled to operate in selecting “BASE” or “STATION” for control group.

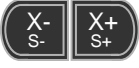
Axis Name		Axis Operation Key	Motion
BASE or STATION	1st axis		The 1st axis moves.
	2nd axis		The 2nd axis moves.
	3rd axis		The 3rd axis moves.

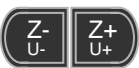
2.3.7 Control Point Operation

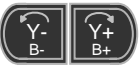
Motion about TCP (Tool Center Point) can only change the wrist orientation at a fixed TCP position in all coordinate systems except the joint coordinates. The motion of each axis is described in the following table.

Axis Motion in Motion about TCP		
Axis Name	Axis Key	Motion
Basic Axes		TCP moves. These movements differ depending on cartesian, cylindrical, tool and user coordinates.
		
		
Wrist Axes		Wrist axes move with the TCP fixed. These movements differ depending on cartesian, cylindrical, tool and user coordinates.
		
		



When two or more axis keys are pressed at the same time, the manipulator will perform compound movement. However, if two different directional keys for the same axis are pressed at the same time (such as [X-] + [X+]), none of the axes operate.

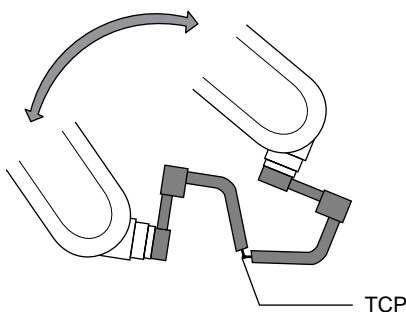

Torch Welding

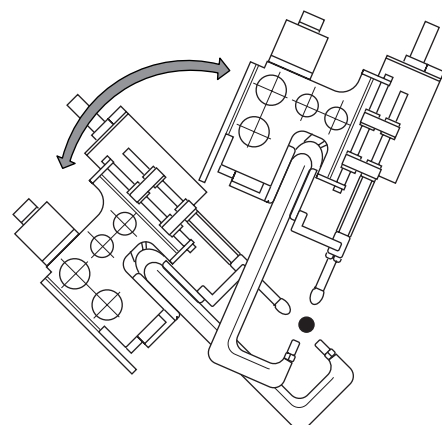

Gun Spot Welding

Turning of each wrist axis differs in each coordinate system.

- In cartesian or cylindrical coordinates, wrist axis rotations are based on the X-, Y-, or Z-axis.

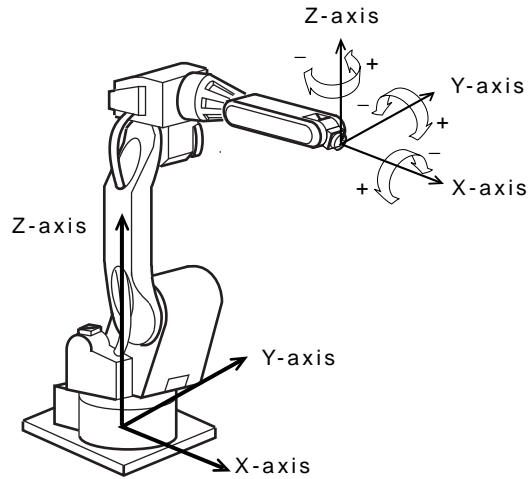

- In tool coordinates, wrist axis rotations are based on X-, Y-, or Z-axis of the tool coordinates.

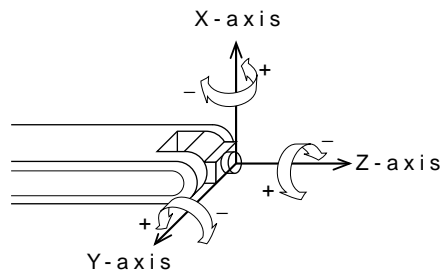

- In user coordinates, wrist axis rotations are based on X-, Y-, or Z-axis of the user coordinates.

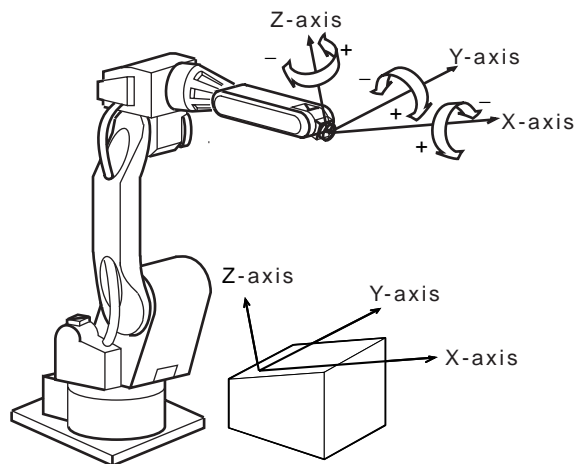

2.3.8 Control Point Change

The tool tip position (TCP) is the target point of axis operations and is set as the distance from the flange face. The control point change operation is an axis operation that involves selecting the tool from a list of registered tools (Refer to “■ Selecting the Tool” in “2.3.4 Tool Coordinates”), and then manipulating the axes while changing the TCP. This can be performed with all coordinates except the joint coordinates. The axis operation is the same as that of the motion about TCP.

<Example 1>TCP Change Operation with Multiple Tools

The TCPs for Tool 1 and Tool 2 are taken as P1 and P2, respectively. When Tool 1 is selected to perform axis operation, P1 (Tool 1’s TCP) is the target point of the operation. Tool 2 follows Tool 1 and is not controlled by axis operation. On the other hand, Tool 2 is selected to perform axis operation, P2 (Tool 2’s TCP) is the target point of axis operation. In this case, Tool 1 follows Tool 2.

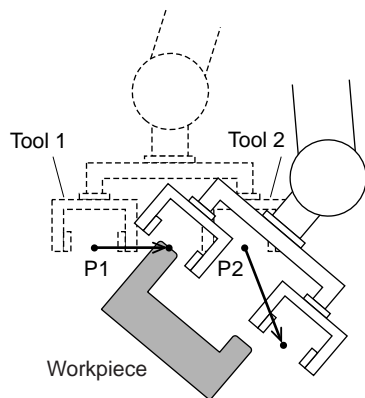

Selection of Tool 1 and axis operations with controlling P1

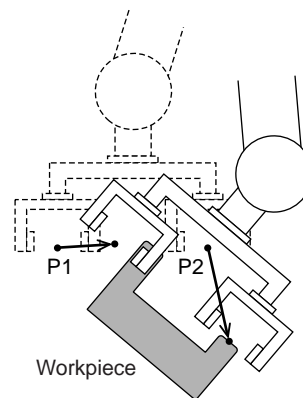

Selection of Tool 2 and axis operations with controlling P2

<Example 2>TCP Change Operation with a Single Tool

The two corners of the workpiece that the tool is holding are taken as TCPs P1 and P2 respectively. By selecting two TCPs alternately, the workpieces can be moved as shown below:

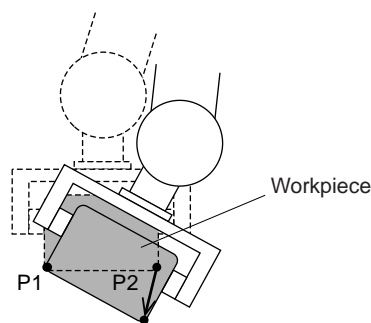

Motion about TCP with P1 selected

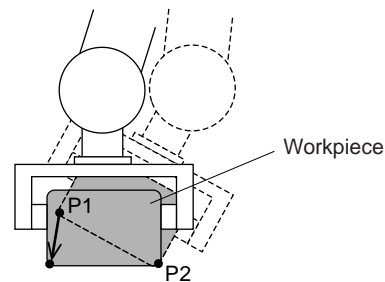

Motion about TCP with P2 selected



For registration of the tool file, refer to “8.3 Tool Data Setting” of “NX100 INSTRUCTIONS” (RE-CTO-A211).

3 Teaching

3.1 Preparation for Teaching

To ensure safety, the following operations should always be performed before teaching:

- Check the emergency stop buttons to be sure they function properly.
- Set the mode switch to “TEACH”.
Then,
- Register a job.

3.1.1 Checking Emergency Stop Buttons

The Servo ON button on the programming pendant should be lit while the power is ON for the servo system. Perform the following operation to ensure that the emergency stop buttons on both the NX100 and the programming pendant are functioning correctly before operating the manipulator.

	Operation	Explanation
1	Press E. STOP button.	Press the emergency stop button on the NX100 or the programming pendant.
2	Confirm the servo power is turned OFF.	The SERVO ON button on the programming pendant lights while servo supply is turned ON. When the emergency stop button is pressed and the servo power is turned OFF, the SERVO ON lamp will turn OFF.
3	Press [SERVO ON READY].	After confirming correct operation, press [SERVO ON READY]. The servo power will be ready to turn ON. The servo power can be turned ON with the Enable switch while the SERVO ON button lamp blinks.

3.1.2 Setting the Teach Lock

For safety purposes, always set the mode switch to “TEACH” before beginning to teach. While the teach lock is set, the mode of operation is tied to the teach mode and the machines cannot be played back using either [START] or external input.

3.1.3 Registering a Job

Specify the name, comments (as required), and control group to register a job.

■ Registering Job Names

Job names can use up to 8 alphanumeric and symbol characters. These different types of characters can coexist within the same job name.

The following rules apply to the designation of names for reserved jobs:

A maximum of six characters can be used for a reserved job name.

When a reserved job name is used, additional characters are added by the system.

<Example>

001 JOB - 1 WORK - A

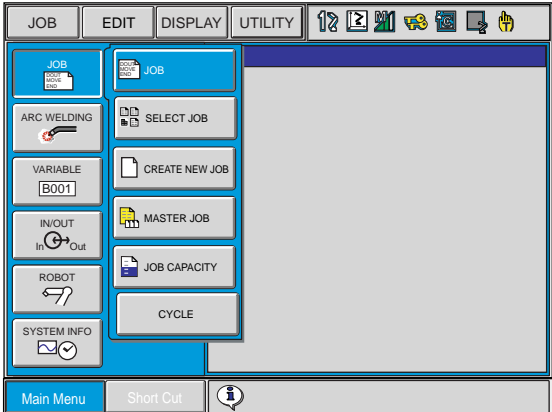
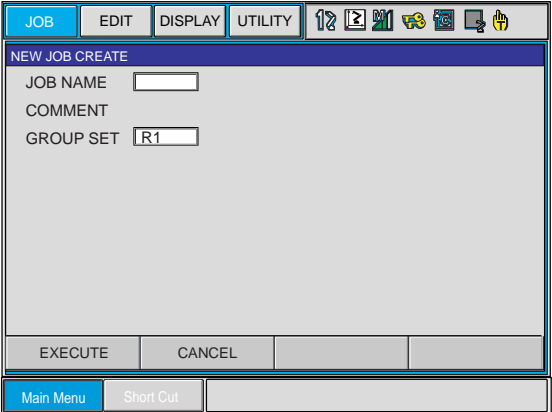
	Operation	Explanation
1	Select {JOB} under the main menu.	The sub-menu appears. 
2	Select {CREATE NEW JOB}.	The NEW JOB CREATE window appears. 
3	Input job name.	Move the cursor to JOB NAME, and press [SELECT]. Input job names using the character input operation. For information on character input operation, refer to "1.2.6 Character Input."
4	Press [ENTER].	

■ Registering Comments

Register a comment using up to 32 alphanumeric and symbol characters as required.

	Operation	Explanation
1	In the NEW JOB CREATE window, move the cursor to the comment and press [SELECT].	
2	Enter the comment.	For information on character input operation, refer to "1.2.6 Character Input."
3	Press [ENTER].	

■ Registering Control Groups

Select the control group that has been registered in advance. If external axes (BASE or STATION) or multiple robot systems are not used, the registration of control groups is not required.

■ Switching to the Teaching Window

After the name, comments (can be omitted), and the control groups have been registered, switch the window to the teaching window as follows:

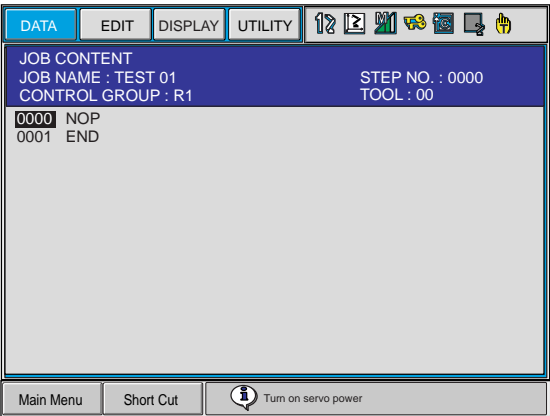
	Operation	Explanation
1	In the NEW JOB CREATE window, press [ENTER] or select "EXECUTE."	<p>Job name, comments, and control groups are all registered. Then, the JOB CONTENT window appears. NOP and END instructions are automatically registered.</p>  <p>The screenshot shows a software window titled 'JOB CONTENT'. At the top, there are tabs for 'DATA', 'EDIT', 'DISPLAY', and 'UTILITY'. Below the tabs, the window displays the following information: 'JOB NAME : TEST 01', 'CONTROL GROUP : R1', 'STEP NO. : 0000', and 'TOOL : 00'. The main area of the window contains two lines of code: '0000 NOP' and '0001 END'. At the bottom of the window, there are three buttons: 'Main Menu', 'Short Cut', and 'Turn on servo power'.</p>

3.2 Teaching Operation

3.2.1 The Teaching Window

Teaching is conducted in the JOB CONTENT window. The JOB CONTENT window contains the following items:

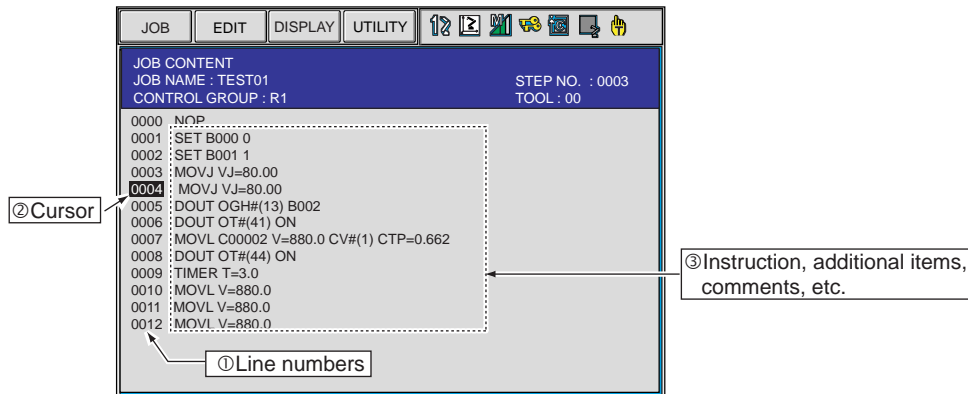

① Line Numbers

The number of the job line is automatically displayed. Line numbers are automatically regenerated if lines are inserted or deleted.

② Cursor

The cursor for manipulator control. For the FWD, BWD, and test operation, the manipulator motion starts from the line this cursor points.

③ Instructions, Additional Items, Comments, Etc.

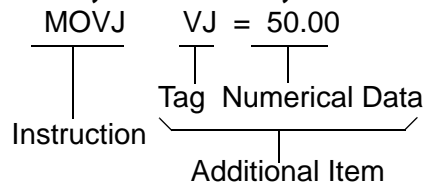

Instructions: These are instructions needed to process or perform an operation. In the case of MOVE instructions, the instruction corresponding to the interpolation type is automatically displayed at the time position is taught.

Additional items: Speed and time are set depending on the type of instruction. Numerical or character data is added when needed to the tags which set conditions.

3.2.2 Interpolation Type and Play Speed

Interpolation type determines the path along which the manipulator moves between playback steps. Play speed is the rate at which the manipulator moves.

Normally the three elements of position data, Interpolation type, and play speed are registered for the robot axes steps at one time. If the interpolation type or play speed settings are omitted during teaching, the data used from the previously taught step is automatically used.

■ Joint Interpolation

The joint interpolation is used when the manipulator does not need to move in a specific path toward the next step position. When the joint interpolation is used for teaching a robot axis, the move instruction is MOVJ. For safety purposes, use the joint interpolation to teach the first step.

When [MOTION TYPE] is pressed, the move instruction on the input buffer line changes.

Play Speed Setting Window

- Speeds are indicated as percentages of the maximum rate.
- Setting “0:Speed Omit” sets the same speed as the previous determination.

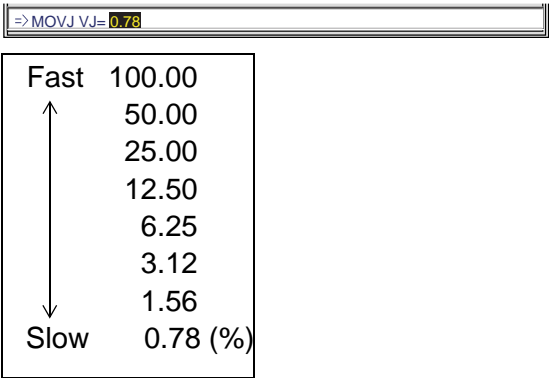
	Operation	Explanation
1	Move the cursor to the play speed.	
2	Set the play speed by pressing [SHIFT] + the cursor key.	<p>The joint speed value increases or decreases.</p> 

■ Linear Interpolation

The manipulator moves in a linear path from one taught step to the next. When the linear interpolation is used to teach a robot axis, the move instruction is MOV L. Linear interpolation is used for work such as welding. The manipulator moves automatically changing the wrist position as shown in the figure below.

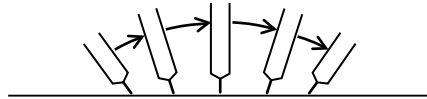

Play Speed Setting Window (same for circular and spline interpolation)

There are two types of displays, and they can be switched depending on the application.

	Operation	Explanation																																		
1	Move the cursor to the play speed.																																			
2	Set the play speed by pressing [SHIFT] + the cursor key.	<p>The play speed value increases or decreases.</p> <div style="border: 1px solid black; padding: 5px; margin: 10px 0;">=> MOV L V= 660</div> <table style="width: 100%; border-collapse: collapse;"> <tr> <td style="width: 50%; border: 1px solid black; padding: 5px; vertical-align: top;"> <table style="width: 100%; border-collapse: collapse;"> <tr><td style="text-align: right;">Fast</td><td style="text-align: left;">1500.0</td></tr> <tr><td style="text-align: center;">↑</td><td style="text-align: left;">750.0</td></tr> <tr><td style="text-align: center;">↑</td><td style="text-align: left;">375.0</td></tr> <tr><td style="text-align: center;">↑</td><td style="text-align: left;">187.0</td></tr> <tr><td style="text-align: center;">↑</td><td style="text-align: left;">93.0</td></tr> <tr><td style="text-align: center;">↑</td><td style="text-align: left;">46.0</td></tr> <tr><td style="text-align: center;">↑</td><td style="text-align: left;">23.0</td></tr> <tr><td style="text-align: left;">Slow</td><td style="text-align: left;">11 (mm/s)</td></tr> </table> </td> <td style="width: 50%; border: 1px solid black; padding: 5px; vertical-align: top;"> <table style="width: 100%; border-collapse: collapse;"> <tr><td style="text-align: right;">Fast</td><td style="text-align: left;">9000</td></tr> <tr><td style="text-align: center;">↑</td><td style="text-align: left;">4500</td></tr> <tr><td style="text-align: center;">↑</td><td style="text-align: left;">2250</td></tr> <tr><td style="text-align: center;">↑</td><td style="text-align: left;">1122</td></tr> <tr><td style="text-align: center;">↑</td><td style="text-align: left;">558</td></tr> <tr><td style="text-align: center;">↑</td><td style="text-align: left;">276</td></tr> <tr><td style="text-align: center;">↑</td><td style="text-align: left;">138</td></tr> <tr><td style="text-align: left;">Slow</td><td style="text-align: left;">66 (cm/min)</td></tr> </table> </td> </tr> </table>	<table style="width: 100%; border-collapse: collapse;"> <tr><td style="text-align: right;">Fast</td><td style="text-align: left;">1500.0</td></tr> <tr><td style="text-align: center;">↑</td><td style="text-align: left;">750.0</td></tr> <tr><td style="text-align: center;">↑</td><td style="text-align: left;">375.0</td></tr> <tr><td style="text-align: center;">↑</td><td style="text-align: left;">187.0</td></tr> <tr><td style="text-align: center;">↑</td><td style="text-align: left;">93.0</td></tr> <tr><td style="text-align: center;">↑</td><td style="text-align: left;">46.0</td></tr> <tr><td style="text-align: center;">↑</td><td style="text-align: left;">23.0</td></tr> <tr><td style="text-align: left;">Slow</td><td style="text-align: left;">11 (mm/s)</td></tr> </table>	Fast	1500.0	↑	750.0	↑	375.0	↑	187.0	↑	93.0	↑	46.0	↑	23.0	Slow	11 (mm/s)	<table style="width: 100%; border-collapse: collapse;"> <tr><td style="text-align: right;">Fast</td><td style="text-align: left;">9000</td></tr> <tr><td style="text-align: center;">↑</td><td style="text-align: left;">4500</td></tr> <tr><td style="text-align: center;">↑</td><td style="text-align: left;">2250</td></tr> <tr><td style="text-align: center;">↑</td><td style="text-align: left;">1122</td></tr> <tr><td style="text-align: center;">↑</td><td style="text-align: left;">558</td></tr> <tr><td style="text-align: center;">↑</td><td style="text-align: left;">276</td></tr> <tr><td style="text-align: center;">↑</td><td style="text-align: left;">138</td></tr> <tr><td style="text-align: left;">Slow</td><td style="text-align: left;">66 (cm/min)</td></tr> </table>	Fast	9000	↑	4500	↑	2250	↑	1122	↑	558	↑	276	↑	138	Slow	66 (cm/min)
<table style="width: 100%; border-collapse: collapse;"> <tr><td style="text-align: right;">Fast</td><td style="text-align: left;">1500.0</td></tr> <tr><td style="text-align: center;">↑</td><td style="text-align: left;">750.0</td></tr> <tr><td style="text-align: center;">↑</td><td style="text-align: left;">375.0</td></tr> <tr><td style="text-align: center;">↑</td><td style="text-align: left;">187.0</td></tr> <tr><td style="text-align: center;">↑</td><td style="text-align: left;">93.0</td></tr> <tr><td style="text-align: center;">↑</td><td style="text-align: left;">46.0</td></tr> <tr><td style="text-align: center;">↑</td><td style="text-align: left;">23.0</td></tr> <tr><td style="text-align: left;">Slow</td><td style="text-align: left;">11 (mm/s)</td></tr> </table>	Fast	1500.0	↑	750.0	↑	375.0	↑	187.0	↑	93.0	↑	46.0	↑	23.0	Slow	11 (mm/s)	<table style="width: 100%; border-collapse: collapse;"> <tr><td style="text-align: right;">Fast</td><td style="text-align: left;">9000</td></tr> <tr><td style="text-align: center;">↑</td><td style="text-align: left;">4500</td></tr> <tr><td style="text-align: center;">↑</td><td style="text-align: left;">2250</td></tr> <tr><td style="text-align: center;">↑</td><td style="text-align: left;">1122</td></tr> <tr><td style="text-align: center;">↑</td><td style="text-align: left;">558</td></tr> <tr><td style="text-align: center;">↑</td><td style="text-align: left;">276</td></tr> <tr><td style="text-align: center;">↑</td><td style="text-align: left;">138</td></tr> <tr><td style="text-align: left;">Slow</td><td style="text-align: left;">66 (cm/min)</td></tr> </table>	Fast	9000	↑	4500	↑	2250	↑	1122	↑	558	↑	276	↑	138	Slow	66 (cm/min)			
Fast	1500.0																																			
↑	750.0																																			
↑	375.0																																			
↑	187.0																																			
↑	93.0																																			
↑	46.0																																			
↑	23.0																																			
Slow	11 (mm/s)																																			
Fast	9000																																			
↑	4500																																			
↑	2250																																			
↑	1122																																			
↑	558																																			
↑	276																																			
↑	138																																			
Slow	66 (cm/min)																																			

■ Circular Interpolation

The manipulator moves in an arc that passes through three points. When circular interpolation is used for teaching a robot axis, the move instruction is MOVC.

Single Circular Arc

When a single circular movement is required, teach the circular interpolation for three points, P1 to P3, as shown in the following figure. If joint or linear interpolation is taught at P0, the point before starting the circular operation, the manipulator moves from P0 to P1 in a straight line.

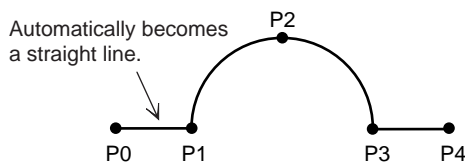

Interpolation Type for Single Circular Arc

	Interpolation Type	Instruction
P0	Joint or Linear	MOVJ MOVL
P1 P2 P3	Circular	MOVC
P4	Joint or Linear	MOVJ MOVL

Continuous Circular Arcs

When continuous circular movement is required, the two arcs must be separated from each other by a joint or linear interpolation step. This step must be inserted between two steps at an identical point. The step at the end point of the preceding circular move must coincide with the beginning point of the following circular move.

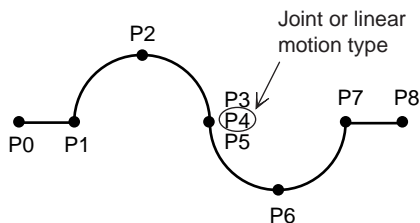

Interpolation Type for Continuous Circular Arc

Point	Interpolation Type	Instruction
P0	Joint or Linear	MOVJ MOVL
P1 P2 P3	Circular	MOVC
P4	Joint or Linear	MOVJ MOVL
P5 P6 P7	Circular	MOVC
P8	Joint or Linear	MOVJ MOVL

Play Speed

The play speed set display is identical to that for the linear interpolation.

The speed taught at P2 is applied from P1 to P2. The speed taught at P3 is applied from P2 to P3.

If a circular operation is taught at high speed, the actual arc path has a shorter radius than that taught.

■ Spline Interpolation

When performing operations such as welding, cutting, and applying primer, using the spline interpolation makes teaching for workpieces with irregular shapes easier. The path of motion is a parabola passing through three points. When spline interpolation is used for teaching a robot axis, the move instruction is MOVJ.

Single Spline Curve

When a single spline curve movement is required, teach the spline interpolation for three points, P1 to P3, as shown in the figure below. If joint or linear interpolation is taught at point P0, the point before starting the spline interpolation, the manipulator moves from P0 to P1 in a straight line.

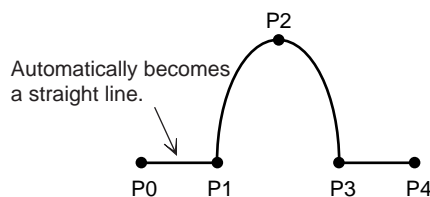

Interpolation Type for a Single Spline Curve

Point	Interpolation Type	Instruction
P0	Joint or Linear	MOVJ MOVL
P1 P2 P3	Spline	MOVJ
P4	Joint or Linear	MOVJ MOVL

Continuous Spline Curves

The manipulator moves through a path created by combining parabolic curves. This differs from the circular interpolation in that steps with identical points are not required at the junction between two spline curves.

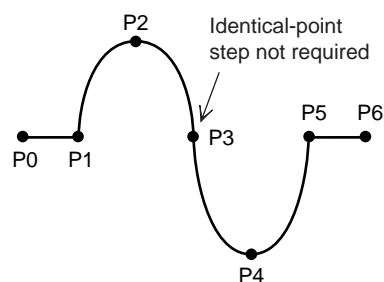

Interpolation Type for Continuous Spline Curves

Point	Interpolation Type	Instruction
P0	Joint or Linear	MOVJ MOVL
P1 to P5	Spline	MOVJ
P6	Joint or Linear	MOVJ MOVL

When the parabolas overlap, a composite motion path is created.



Play Speed

The play speed setting window is identical to that for the linear interpolation. As with the circular interpolation, the speed taught at P2 is applied from P1 to P2, and the speed taught at P3 is applied from P2 to P3.



Teach points so that the distances between the three points are roughly equal. If there is any significant difference, an error will occur on playback and the manipulator may operate in an unexpected, dangerous manner. Ensure that the ratio of distances between steps $m:n$ is within the range of 0.25 to 0.75.

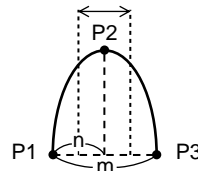

3.2.3 Teaching Steps

■ Registering Move Instructions

Whenever one step is taught, one move instruction is registered. There are two ways to teach a step. Steps can be taught in sequence as shown in the following left figure "Registering Move Instructions" or they can be done by inserting steps between already registered steps, as shown in the right figure "Inserting Move Instructions." This paragraph explains the teaching of "Registering Move Instructions," the operations involved in registering new steps.

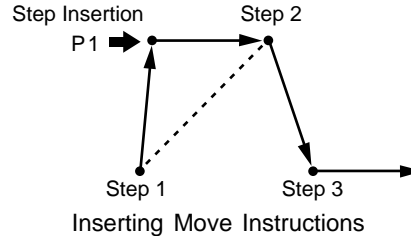
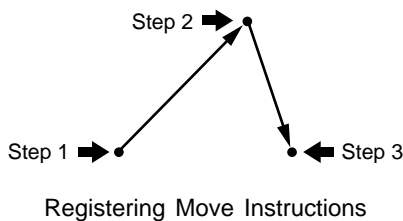

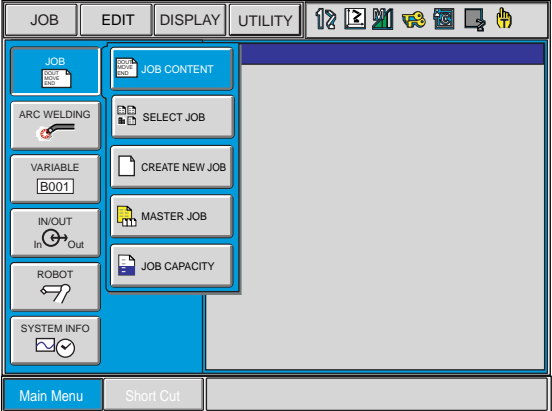

Teaching of "Inserting Move Instructions" is called "Inserting move instruction," to distinguish it from the method shown in "Registering Move Instructions." For more details on this operation, see "3.4.2 Inserting Move Instructions." The basic operations for registration and insertion are the same. The only difference is pressing [INSERT] in the case of insertion. For registration ("Registering Move Instructions"), the instruction is always registered before the END instruction. Therefore, it is not necessary to press [INSERT]. For insertion ("Inserting Move Instructions"), [INSERT] must be pressed.

Setting the Position Data

	Operation	Explanation
1	Select {JOB} under the main menu.	<p>The sub-menu appears.</p> 
2	Select {JOB}.	<p>The contents of the currently-selected job is displayed.</p> <pre data-bbox="772 882 1331 1048"> 0000 NOP 0001 MOVJ VJ=25.00 0002 MOVJ VJ=25.00 0003 MOVJ VJ=12.50 0004 ARCON ASF#(1) 0005 MOVL V=66 0006 END </pre>
3	Move the cursor on the line immediately before the position where a move instruction to be registered.	
4	Grip the Enable switch.	Grip the Enable switch to turn the servo power ON.
5	Move the manipulator to the desired position using the axis key.	Use the axis operation key to move the manipulator to the desired position.

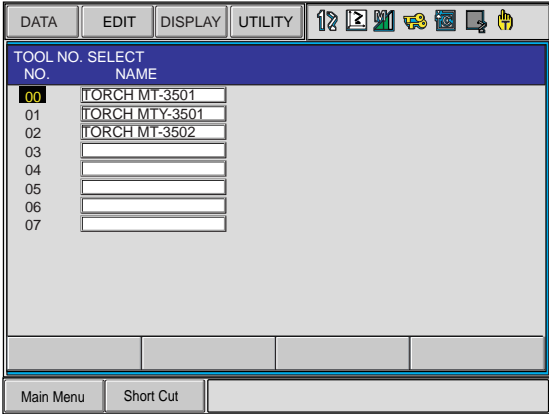
Selecting the Tool Number

	Operation	Explanation
1	Press [SHIFT] + [COORD].	<p>When selecting the "JOINT," "XYZ/CYLINDRICAL," or "TOOL" coordinates, press [SHIFT] + [COORD] and the TOOL NO. SELECT window will be shown.</p> 
2	Select desired tool number.	<p>The contents of the currently-selected job is displayed.</p> 
3	Press [SHIFT] + [COORD].	The JOB CONTENT window appears.





Using Multiple Tools with One Manipulator

When multiple tools are to be used with one manipulator, set parameter S2C333 to 1. See " 2.3.4 Tool Coordinates " for details on this operation.

Setting the Interpolation Type

	Operation	Explanation
1	Press [MOTION TYPE].	When [MOTION TYPE] is pressed, MOVJ → MOVL → MOVC → MOVS are displayed in order in the input buffer line.
2	Select the desired interpolation type.	

Setting the Play Speed

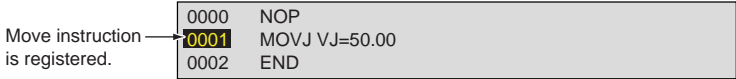
	Operation	Explanation
1	Move the cursor to the instruction.	
2	Press [SELECT].	The cursor moves to the input buffer line. 
3	Move the cursor to the play speed to be set.	
4	Press [SHIFT] + the cursor key [↑] or [↓] simultaneously.	The joint speed moves up and down. 
5	Press [ENTER].	The MOV instruction is registered. 

Follow the above instructions when conducting teaching. (Tool number, interpolation type, or play speed does not need to be set if it is same as the previous step.)



- The position level can be set at the same time that the move instruction is registered.
- To make the setting so that the play speed tag is not displayed as a default, select {EDIT} from the menu and then select “ENABLE PLAY SPEED TAG” to delete “*.”

Setting Position Level

The position level is the degree of approximation of the manipulator to a taught position. The position level can be added to move instructions MOVJ (joint interpolation) and MOVL (linear interpolation). If the position level is not set, the precision depends on the operation speed. Setting an appropriate level moves the manipulator in a path suitable to circumferential conditions and the workpiece. The relationship between path and accuracy for position levels is as shown below.



To display the position level tag as a default, select {EDIT} from the menu and then select “ENABLE POS LEVEL TAG.”

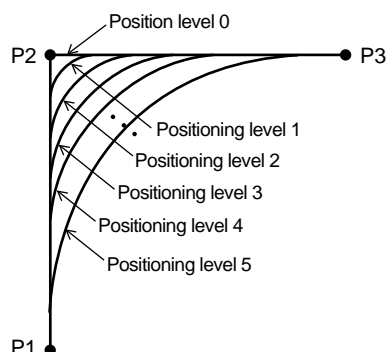

Position Levels	Accuracy
0	Teaching position
1 to 10	Fine Rough

3.2 Teaching Operation

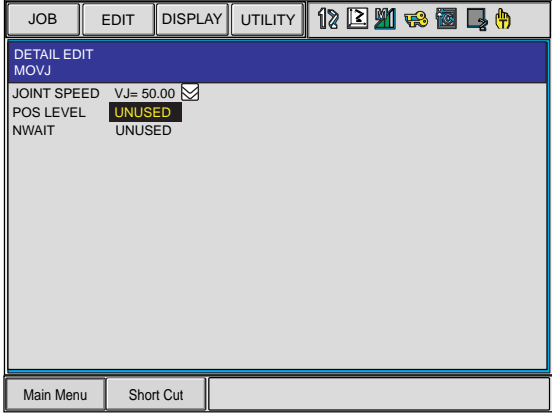
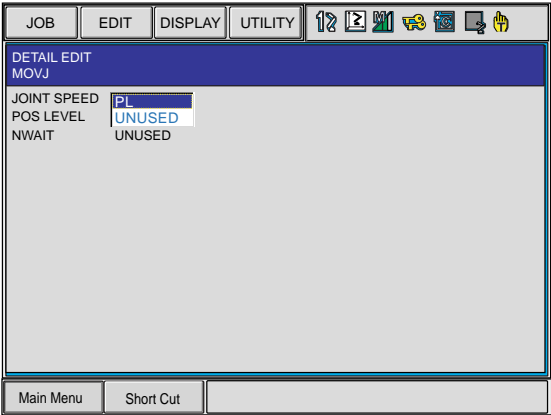
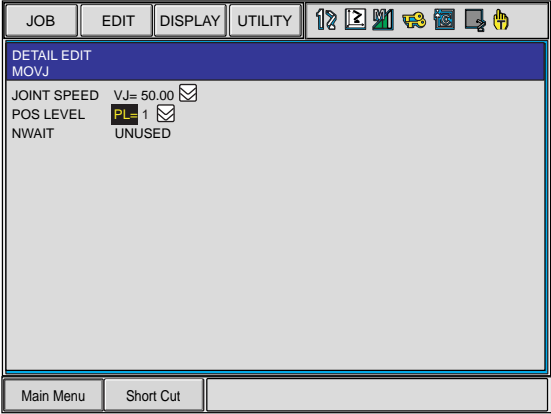
Operation	Explanation
1 Select move instruction.	<p>The DETAIL EDIT window appears.</p>  <p>The screenshot shows a software window titled 'DETAIL EDIT' with a blue header bar. Below the header, the text 'MOVJ' is displayed. The main area contains three lines of text: 'JOINT SPEED VJ= 50.00' with a checked checkbox, 'POS LEVEL UNUSED' with a yellow highlight, and 'NWAIT UNUSED'. At the bottom of the window, there are two buttons: 'Main Menu' and 'Short Cut'.</p>
2 Select the position level "UNUSED."	<p>The selection dialog box appears.</p>  <p>The screenshot shows the same 'DETAIL EDIT' window as in step 1. A small white selection dialog box is overlaid on the 'POS LEVEL UNUSED' text, with a blue highlight on the 'PL' part of the text.</p>
3 Select "PL."	<p>The position level is displayed. The position initial value is 1.</p>  <p>The screenshot shows the 'DETAIL EDIT' window with the 'POS LEVEL' now set to 'PL= 1'. The 'PL= 1' text is highlighted in yellow, and there is a checked checkbox next to it. The 'NWAIT UNUSED' text remains below it.</p>

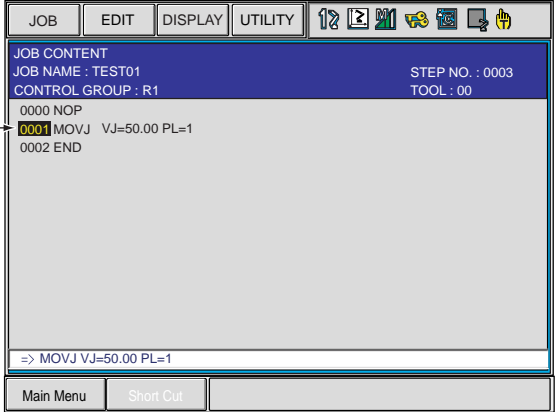
	Operation	Explanation
4	Press [ENTER].	<p>To change the position level, select the level in the input buffer line, type the value using the Numeric keys, and press [ENTER]. The position level's move instruction is registered.</p> 
5	Press [ENTER].	

To perform the movement steps shown below, set as follows:

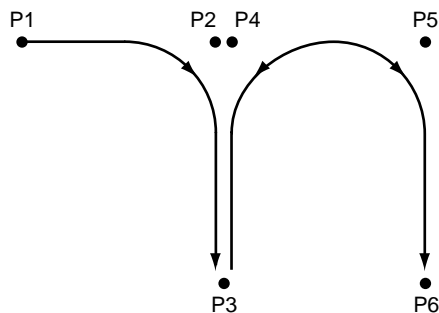

Steps P2, P4, and P5 are simple passing points, and do not require accurate positioning. Adding PL=1 to 8 to the move instructions of these steps moves the manipulator around the inner corners, thereby reducing the cycle time.

If complete positioning is necessary as P3 or P6, add PL=0.

<EXAMPLE>

Passing points P2, P4, and P5:

MOVL V=138 PL=3

Positioning point P3 and P6:

MOVL V=138 PL=0

■ Registering Reference Point Instructions

Reference point instructions (REFP) set an auxiliary point such as a wall point for weaving. Reference point Nos. 1 to 8 are assigned for each application. Follow these procedures to register reference point instructions.





	Operation	Explanation
1	Select {JOB} under the main menu.	
2	Select {JOB}.	
3	Move the cursor.	<p>Move the cursor to the line immediately before the position where the reference point to be registered.</p> <div style="border: 1px solid gray; padding: 5px; margin-top: 10px;"> <p>Place immediately before where reference point is to be registered. →</p> <pre>0003 MOVL V=558 0004 CALL JOB: TEST 0005 MOVL V=138</pre> </div>
4	Grip the Enable switch.	The servo power is turned ON.
5	Press the axis operation key.	Move the manipulator to the position to be registered as the reference point.
6	Press [REFP] or select "REFP" from the inform list.	<p>The reference point instruction is displayed in the input buffer line.</p> <div style="border: 1px solid gray; padding: 5px; margin-top: 10px;"> <p>⇒ REFP 1</p> </div>
7	<p>Change the reference point number in one of the following ways.</p> <p>1: Move the cursor to the reference point number, and press [SHIFT] + the cursor key to change the reference point number; or</p> <p>2: Press [SELECT] when the cursor is on the reference point number. Then, the data input buffer line appears. Input the number and press [ENTER].</p>	<div style="border: 1px solid gray; padding: 5px; margin-top: 10px;"> <p>⇒ REFP 2</p> </div> <div style="border: 1px solid gray; padding: 5px; margin-top: 10px;"> <p>Ref-point No.=</p> <p>⇒ REFP</p> </div>
8	Press [INSERT].	<p>The [INSERT] key lamp lights.</p> <p>When registering before the END instruction, pressing [INSERT] is not needed.</p>
9	Press [ENTER].	<p>The REFP instruction is registered.</p> <div style="border: 1px solid gray; padding: 5px; margin-top: 10px;"> <p>Reference point is registered. →</p> <pre>0003 MOVL V=558 0004 CALL JOB: TEST 0005 REFP 1 0006 MOVL V=138</pre> </div>



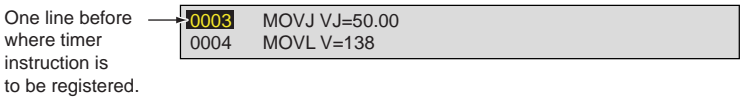

The programming pendant does not have the [REFP] key for the application of spot welding, general purposes (= material handling, assembling, cutting) or motor gun.

■ Registering Timer Instructions

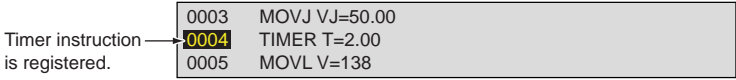
The timer instruction stops the manipulator for a specified time. Follow these procedures to register timer instructions.

	Operation	Explanation
1	Select {JOB} under the main menu.	
2	Select {JOB}.	
3	Move the cursor.	<p>Move the cursor to one line before the position where the timer instruction is to be registered.</p> 
4	Press [TIMER].	<p>The TIMER instruction is displayed on the input buffer line.</p> 
5	Change the timer value.	<p>Move the cursor to the timer value and change it by pressing [SHIFT] + the cursor key. The timer unit of adjustment is 0.01 seconds.</p>  <p>If you use the Numeric keys to input the timer value, press [SELECT] when the cursor is on the timer value. The data input line appears. Input the value and press [ENTER].</p> 
6	Press [INSERT].	<p>The [INSERT] key lamp lights. When registering before the END instruction, pressing [INSERT] is not needed.</p>
7	Press [ENTER].	<p>The TIMER instruction is registered.</p> 

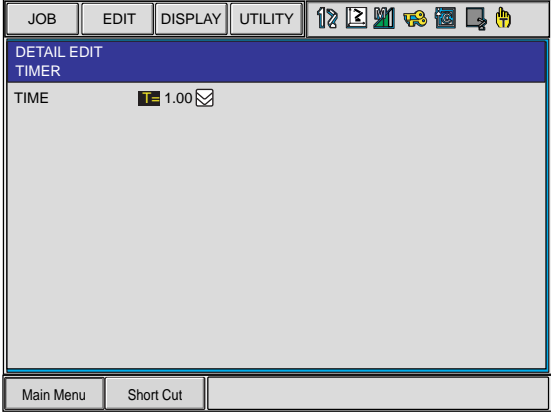
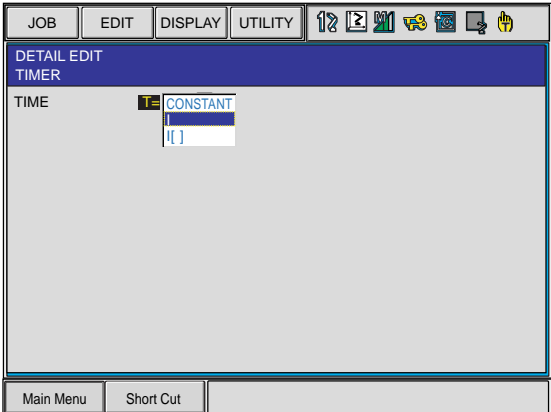
Changing Timer Value

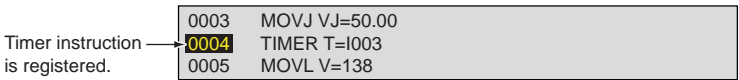
	Operation	Explanation
1	Press [TIMER].	
2	Press [SELECT].	<p>The DETAIL EDIT window for the TIMER instruction appears.</p> 
3	Input the timer value on the instruction DETAIL EDIT window.	<p>When <input checked="" type="checkbox"/> is selected, the items available to be changed are displayed in the dialog box. Select the particular item to be changed.</p>  <p>When a number is to be changed, move the cursor to the number and press [SELECT]. Input the desired value using the Numeric keys, and press [ENTER].</p> 
4	Press [ENTER].	<p>The DETAIL EDIT window is closed and the JOB CONTENT window appears again. Modified content is displayed in the input buffer line.</p> 
5	Press [INSERT].	<p>The [INSERT] key lamp lights. When registering before the END instruction, pressing [INSERT] is not needed.</p>
6	Press [ENTER].	<p>The TIMER instruction is registered.</p>  <pre> 0003 MOVJ VJ=50.00 0004 TIMER T=1003 0005 MOVL V=138 </pre> <p>Timer instruction is registered. →</p>

3.2.4 Overlapping the First and Last Steps



Why is overlapping the first and last step necessary?

Assume that the job shown below is to be repeated. The manipulator moves from the last step (Step 6) to the first step (Step 1). If Step 6 and Step 1 are the same position, the manipulator moves directly Step 5 to Step 1, thereby improving work efficiency.

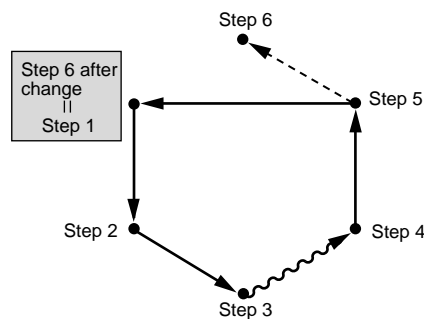

The position of step 6 is changed to overlap with step 1.

	Operation	Explanation
1	Move the cursor to the first step line.	
2	Press [FWD].	The manipulator moves to the first step position.
3	Move the cursor to the last step line.	The cursor starts blinking. When the cursor line position and the manipulator position are different in the JOB CONTENT window, the cursor blinks.
4	Press [MODIFY].	The key lamp lights.
5	Press [ENTER].	The position data for the first step is registered on the line of the last step. At this time, only the position data can be changed in the last step. Interpolation type and play speed do not change.

3.3 Checking Steps

3.3.1 FWD/BWD Key Operations

Check whether the position of the taught steps is appropriate using [FWD] or [BWD] on the programming pendant. Each time [FWD] or [BWD] is pressed, the manipulator moves by a single step.

[FWD]: Moves the manipulator ahead in step number sequence. Only the move instruction is executed when [FWD] is pressed, but when [INTERLOCK] + [FWD] are pressed, all instructions are executed.

[BWD]: Moves the manipulator backward a step at a time in reverse step number sequence. Only the move instruction is executed.



For safety, set manual speed at or below.

	Operation	Explanation
1	Move the cursor to the step to be checked.	
2	Press [FWD] or [BWD].	The manipulator reaches the following / previous step and stops.

■ Precautions When Using FWD / BWD Operations

FWD Movements

- The manipulator moves in step number sequence. Only move instructions are executed when [FWD] is pressed. To execute all instructions, press [INTERLOCK] + [FWD].
- The manipulator stops after playing a single cycle. It does not move after the END instruction is reached, even if [FWD] is pressed. However, at the end of a called job, the manipulator moves the instruction next to the CALL instruction.

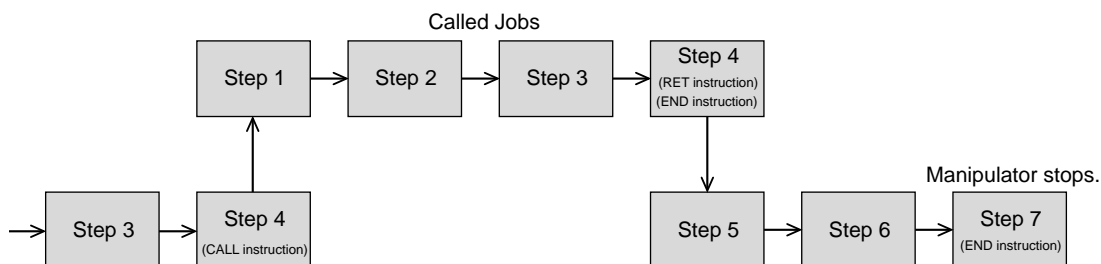

BWD Movements

- The manipulator moves in reverse step number sequence. Only move instructions are executed.
- The manipulator stops after playing a single cycle. It does not move after the first step is reached, even if [BWD] is pressed. However, at the beginning of a called job, the manipulator moves to the instruction immediately before the CALL instruction.

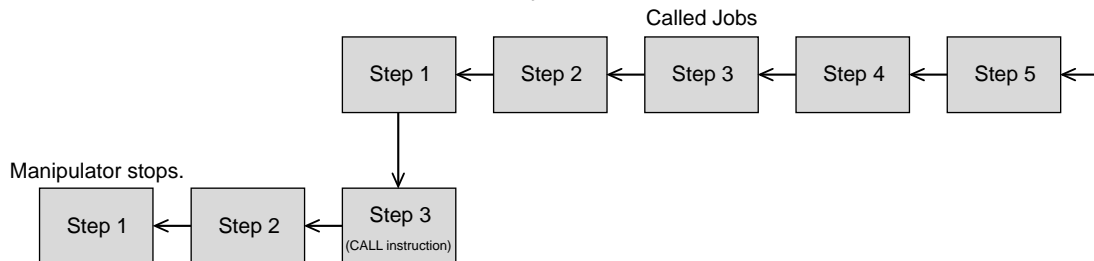

Circular Movements with FWD/BWD Key Operations

- The manipulator moves in a straight line to the first step of the circular interpolation.
- There must be three circular interpolation steps in a row to move the manipulator in an arc.
- If [FWD] or [BWD] operation is restarted after being stopped to move the cursor or to perform search, the manipulator moves in a straight line to the next step.
- If [FWD] or [BWD] operation is restarted after being stopped to move the axis as shown in the following, the manipulator moves in a straight line to P2, the next circular interpolation. Circular motion is restored from P2 and P3.

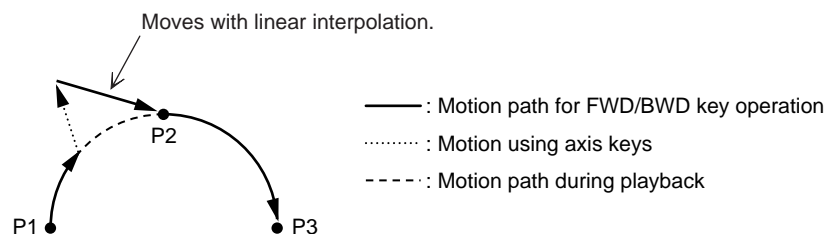

Spline Curve Movements with FWD/BWD Operations

- The manipulator moves in a straight line to the first step of spline interpolation.
- There must be three spline curve motion steps in a row to perform a spline curve operation.
- Depending on the position where the [FWD] / [BWD] operation is performed, the alarm “IRREGULAR DISTANCES BETWEEN TEACHING POINTS” may occur. Note that FWD/BWD inching operations change the path of the manipulator and **caution is therefore required**. Performing these operations also increases the likelihood that the “IRREGULAR DISTANCES BETWEEN TEACHING POINTS” will occur.
- If the [FWD] or [BWD] operation is restarted after being stopped to move the cursor or perform a search, the manipulator moves in a straight line to the next step.
- If the [FWD] or [BWD] operation is restarted after being stopped to move the axis as shown in the following, the manipulator moves in a straight line to P2, the next spline curve motion step. Spline curve motion is restored from P2 onward. However, the path followed between P2 and P3 is somewhat different from the path followed at playback.

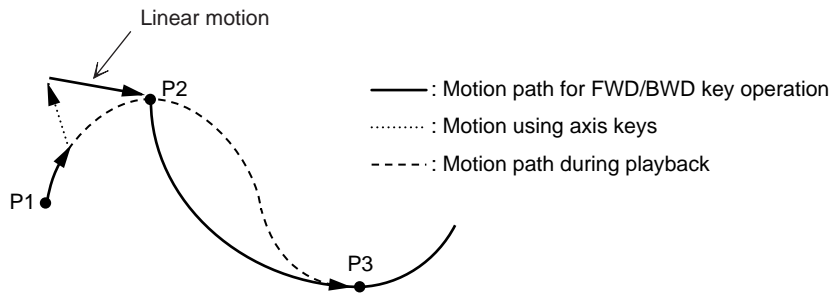

- If the manipulator is moved to P3 with [FWD], stopped, and then returned to P2 with [BWD], the path followed between P2 and P3 is different for each of the following: the first FWD operation, the BWD operation, and the consequent FWD operation.

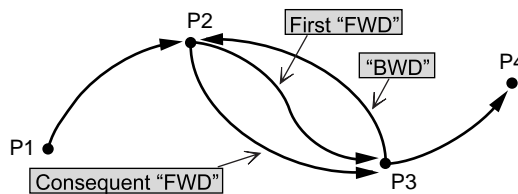

■ Selecting Manual Speed

When [FWD] or [BWD] is pressed, the manipulator moves at the manual speed selected at that time. Selected manual speed can be checked by the manual speed indication on the programming pendant.

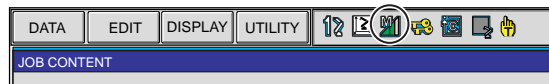

Manual speed is set with [FAST] and [SLOW]. FWD operation can be performed at a high speed by pressing [HIGH SPEED]. Follow these procedures to select a manual speed.

- Each time [FAST] is pressed, the speed is changed to the next setting in the following sequence: INCH, SLW, MED, and FST.

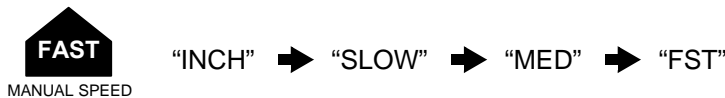

- Each time [SLOW] is pressed, the speed is changed to the next setting in the following sequence: FST, MED, SLW, and INCH.



NOTE • FWD/BWD operation is performed with SLW speed even if INCH is selected.
 • [HIGH SPEED] is available only for the FWD operation but not for BWD operation.

■ Moving to Reference Point

To check the position of a taught reference point, follow these procedures to move the manipulator to the reference point.

	Operation	Explanation
1	Move the cursor to the reference point instruction line to be checked.	
2	Press [REFP] + [FWD].	The manipulator moves to the reference point of the cursor line.

■ Test Operations

Playback operations can be simulated in the teach mode with test operations. This function is convenient for checking continuous paths and operation instructions.

Test operation differs in the following ways from actual playback in the play mode.



- Operation speeds greater than the maximum teaching speed are reduced to the maximum teaching speed.
- Only machine lock is available among special operations for playback in the play mode.
- Work instruction output, such as arc output, is not executed.

Test operation is performed by pressing [INTERLOCK] and [TEST START]. For safety purposes, these keys will only function while the keys are held down.



Always check safety conditions before pressing [INTERLOCK] + [TEST START] to start the manipulator in motion.

	Operation	Explanation
1	Select {JOB} under the main menu.	
2	Press {JOB}.	The test operation JOB CONTENT window appears.
3	Press [INTERLOCK] + [TEST START].	The manipulator starts the test cycle operation. However, after the operation starts, the motion continues even if [INTERLOCK] is released. The manipulator moves only while these keys are held down. The manipulator stops immediately when [TEST START] is released.

3.4 Modifying Steps

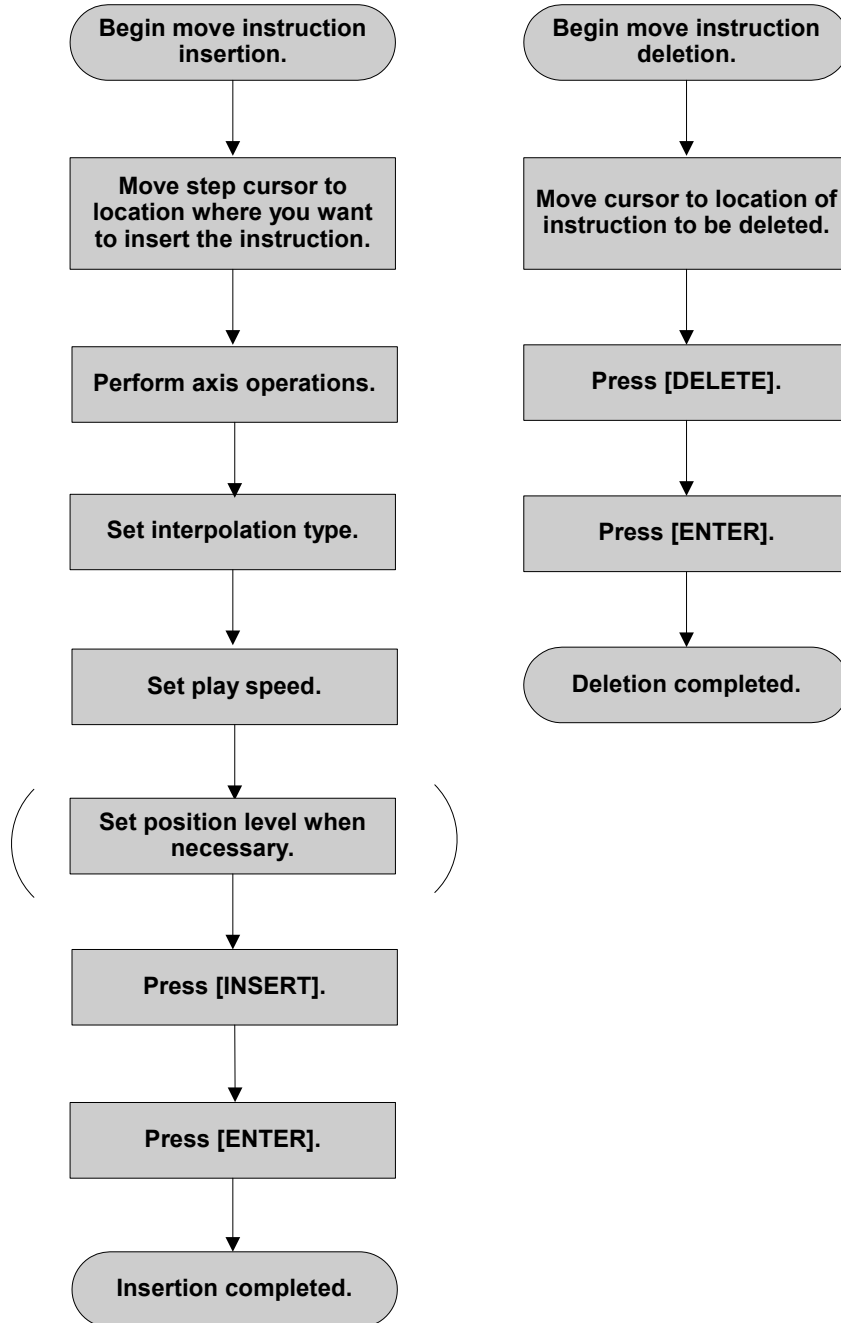

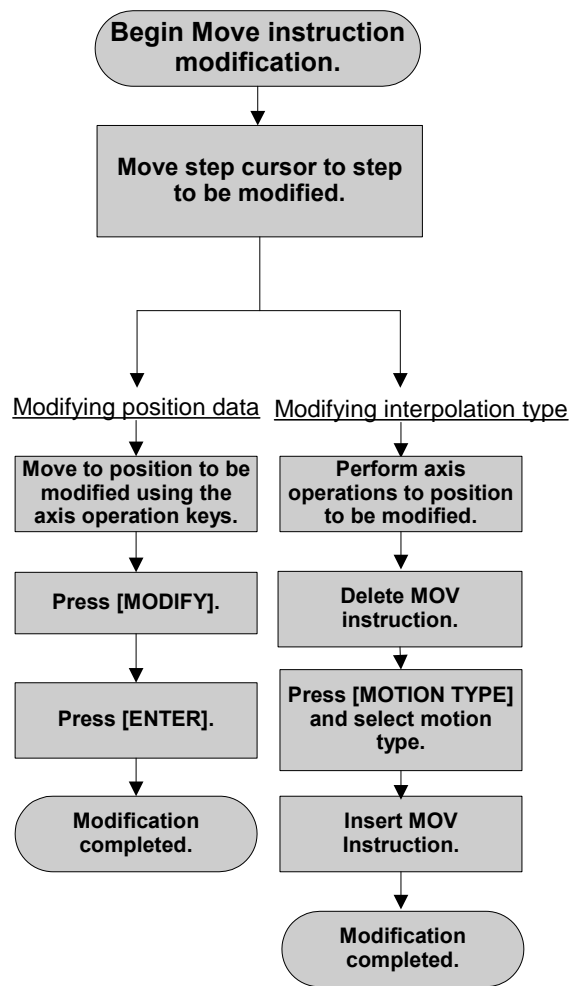

It is not possible to change a move instruction to a reference point instruction and vice versa.

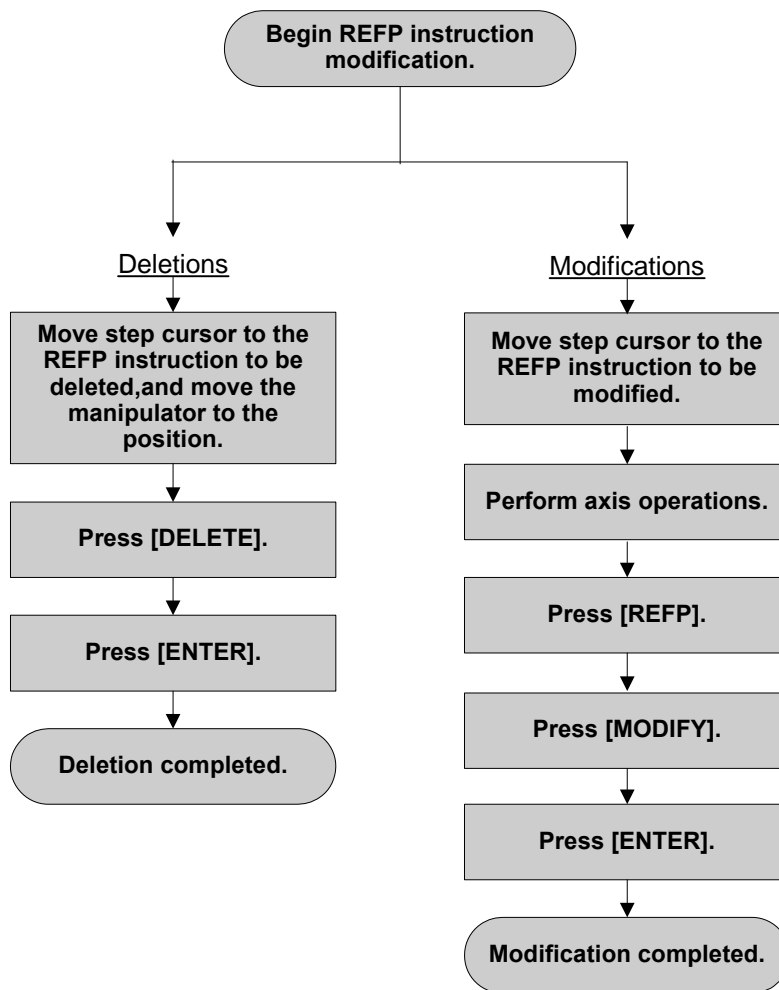

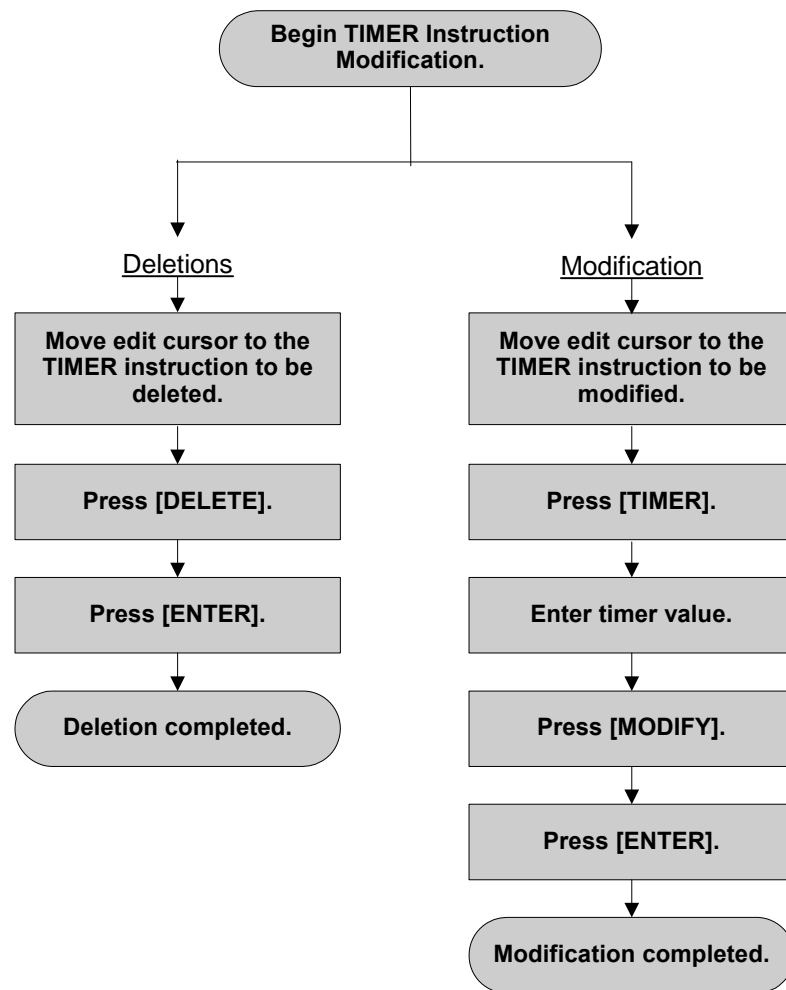

3.4.1 Displaying the JOB CONTENT Window for Editing

■ Currently Called Up Job

	Operation	Explanation
1	Select {JOB} under the main menu.	
2	Select {JOB}.	The JOB CONTENT window appears.

■ Calling Up Other Jobs

NOTE In any other than the teach mode, set the mode switch to "TEACH."

	Operation	Explanation
1	Select {JOB} under the main menu.	
2	Select {SELECT JOB}.	The JOB LIST window appears.
3	Select the job name to be called.	

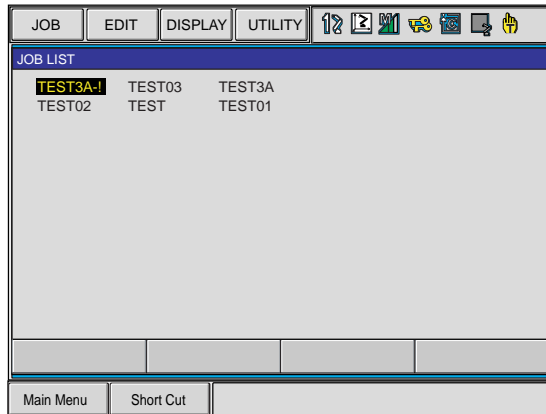

3.4.2 Inserting Move Instructions

NOTE Move instructions cannot be inserted when the servo power is OFF.

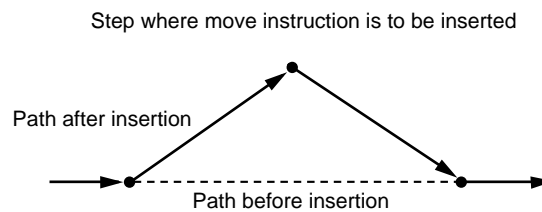

	Operation	Explanation
1	Move the cursor to the line immediately before the insert position.	<p>The line immediately before where the move instruction is to be added.</p> <pre> 0006 MOVL V=276 0007 TIMER T=1.00 0008 DOUT OT#(1) ON 0009 MOVJ VJ=100.0 </pre>
2	Press the axis operation key.	<p>Turn ON the servo power and press the axis operation key to move the manipulator to the position to be inserted.</p> <p>NOTE Confirm the move instruction on the input buffer line and set desired interpolation type and play speed.</p>
3	Press [INSERT].	<p>The key lamp will light.</p> <p>NOTE When the inserting position is immediately before the END instruction, pressing [INSERT] is not needed.</p>
4	Press [ENTER].	<p>The move instruction is inserted after the cursor line.</p> <pre> 0006 MOVL V=276 0007 TIMER T=1.00 0008 DOUT OT#(1) ON 0009 MOVL V=558 0010 MOVJ VJ=100.0 </pre> <p><Examples of Inserting a Move Instruction> When a move instruction is inserted in the following job, it is placed on different lines according to the setting in the TEACHING CONDITION window.</p> <div style="display: flex; justify-content: space-around;"> <div style="text-align: center;"> <p>Before inserting the move instruction</p> <pre> Cursor line → 0006 MOVL V=276 0007 TIMER T=1.00 0008 DOUT OT#(1) ON 0009 MOVJ VJ=100.0 </pre> </div> <div style="text-align: center;"> <p>After the insertion: when inserting before the next step</p> <pre> Added instruction → 0006 MOVL V=276 0007 TIMER T=1.00 0008 DOUT OT#(1) ON 0009 MOVL V=558 0010 MOVJ VJ=100.0 </pre> </div> <div style="text-align: center;"> <p>After the insertion: when inserting after the cursor line</p> <pre> Added instruction → 0006 MOVL V=276 0007 MOVL V=558 0008 TIMER T=1.00 0009 DOUT OT#(1) ON 0010 MOVJ VJ=100.0 </pre> </div> </div>



Positions where the move instructions are inserted.

The default location for insertions is for “before the next step,” but it is also possible to insert “after the cursor line.” This setting is made in the “Move Instruction Register Method” in the TEACHING CONDITION window.

3.4.3 Deleting Move Instructions

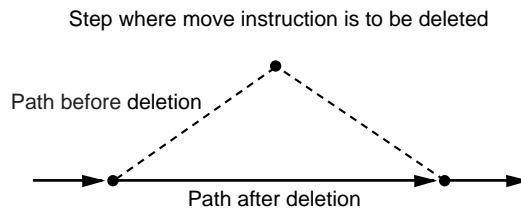

	Operation	Explanation						
1	Move the cursor to the move instruction to be deleted.	<div style="border: 1px solid gray; padding: 5px; width: fit-content;"> <table style="width: 100%; border-collapse: collapse;"> <tr> <td style="width: 15%; border: none;">0003</td> <td style="border: none;">MOVL V=138</td> </tr> <tr> <td style="border: none;">0004</td> <td style="border: none;">MOVL V=558</td> </tr> <tr> <td style="border: none;">0005</td> <td style="border: none;">MOVJ VJ=50.00</td> </tr> </table> </div> <p style="margin-top: 10px;">Move instruction to be deleted →</p> <div style="border: 2px solid blue; padding: 10px; margin-top: 10px;"> <p>NOTE If the manipulator position differs from the cursor position on the window, the cursor blinks. Stop the blinking by either of the following procedures.</p> <ul style="list-style-type: none"> • Press [FWD] and move the manipulator to the position where the move instruction is to be deleted. • Press [MODIFY]→ [ENTER] to change the position data of the blinking cursor position to the current manipulator position. </div>	0003	MOVL V=138	0004	MOVL V=558	0005	MOVJ VJ=50.00
0003	MOVL V=138							
0004	MOVL V=558							
0005	MOVJ VJ=50.00							
2	Press [DELETE].	The key lamp will blink.						
3	Press [ENTER].	<p>The step indicated by cursor line is deleted.</p> <div style="border: 1px solid gray; padding: 5px; width: fit-content; margin-top: 10px;"> <table style="width: 100%; border-collapse: collapse;"> <tr> <td style="width: 15%; border: none;">0003</td> <td style="border: none;">MOVL V=138</td> </tr> <tr> <td style="border: none;">0004</td> <td style="border: none;">MOVJ VJ=50.00</td> </tr> </table> </div>	0003	MOVL V=138	0004	MOVJ VJ=50.00		
0003	MOVL V=138							
0004	MOVJ VJ=50.00							

3.4.4 Modifying Move Instructions

■ Modifying Position Data

	Operation	Explanation
1	Move the cursor to the MOV instruction to be modified.	Display the JOB CONTENT window and move the cursor to the move instruction to be changed.
2	Press the axis operation key.	Turn ON the servo power and press the axis operation key to move the manipulator to the desired position.
3	Press [MODIFY].	The key lamp will blink.
4	Press [ENTER].	The position data in the present position is registered. <div style="border: 1px solid black; padding: 5px; display: inline-block;">  For MOV instructions for which position variables have been set, the position variables will not be changed. </div>

■ Modifying Interpolation Type



Modifying only interpolation type is impossible. The interpolation type can be modified as a choice for modifying the position data.

	Operation	Explanation
1	Move the cursor to the move instruction to be modified.	Display the JOB CONTENT window, and move the cursor to the move instruction for which interpolation type is to be changed.
2	Press [FWD].	Turn ON the servo power and press [FWD] to move the manipulator to the position of the move instruction.
3	Press [DELETE].	The key lamp will blink.
4	Press [ENTER].	The cursor line step is deleted.
5	Press [MOTION TYPE].	Press [MOTION TYPE] to change the interpolation type. Each time [MOTION TYPE] is pressed, the input buffer line instruction alternates.
6	Press [INSERT].	
7	Press [ENTER].	The interpolation type and position data are changed at the same time.

3.4.5 Undo Operation

After inserting, deleting, or modifying an instruction, the operation can be undone. The UNDO operation becomes enabled by selecting {EDIT}→{ENABLE UNDO}, and becomes disabled by selecting {EDIT}→{*ENABLE UNDO} while editing a job.

NOTE The undo operation can be performed even after the manipulator is moved by the FWD or BWD operation or test operation after inserting, deleting, or modifying a move instruction. However, the undo operation cannot be performed if other instructions are edited or a job is executed in the play mode after editing the move instruction. The undo operation works only for the last five edited instructions only.

	Operation	Explanation
1	Press [ASSIST].	The assist menu appears. 
2	Select {UNDO}.	The last operation is undone.
3	Select {REDO}.	The last UNDO operation is undone.

3.4.6 Modifying Reference Point Instructions

■ Deleting Reference Point Instructions

NOTE If the manipulator position differs from the cursor position, an error message is displayed. If this occurs, follow either of the procedures below.

- Press [REFP] + [FWD] to move the manipulator to the position to be deleted.
- Press [MODIFY] then [ENTER] to change the reference point position data to the current position of the manipulator.



	Operation	Explanation
1	Move the cursor to the reference point instruction to be deleted.	
2	Press [DELETE].	The key lamp will blink.
3	Press [ENTER].	The reference point instruction at the cursor line is deleted.

■ Modifying Reference Point Instructions

	Operation	Explanation
1	Move the cursor to the reference point instruction to be modified.	
2	Move the manipulator with the axis operation keys.	Turn ON the servo power and use the axis operation keys to move the manipulator to the desired position.
3	Press [REFP].	
4	Press [MODIFY].	The key lamp will light.
5	Press [ENTER].	The reference point instruction at the cursor line is changed.

3.4.7 Modifying Timer Instructions

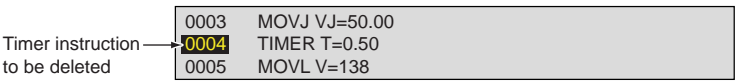
■ Deleting Timer Instructions

	Operation	Explanation
1	Move the cursor to the timer instruction to be deleted.	
2	Press [DELETE].	The key lamp will light.
3	Press [ENTER].	The timer instruction at the cursor line is deleted. 

■ Modifying Timer Instructions

	Operation	Explanation
1	Move the cursor to the timer instruction to be modified.	<pre> 0003 MOVJ VJ=50.00 0004 TIMER T=0.50 0005 MOVL VJ=138 0006 MOVL VJ=138 </pre>
2	Press [TIMER].	<pre> 0003 MOVJ VJ=50.00 0004 TIMER T=0.50 0005 MOVL VJ=138 0006 MOVL VJ=138 </pre>
3	Move the cursor to the input buffer line timer value.	<p>Move the cursor to the input buffer line timer value and press [SHIFT] + the cursor key to set the data. To use the Numeric keys to input data, move the cursor to the input buffer line timer value and press [SELECT].</p> <pre> => TIMER T=0.50 </pre>
4	Change the timer value.	
5	Press [MODIFY].	This key lamp will light.
6	Press [ENTER].	<p>The timer instruction at the cursor line is changed.</p> <pre> 0003 MOVJ VJ=50.00 0004 TIMER T=1.00 0005 MOVL VJ=138 0006 MOVL VJ=138 </pre>

3.5 Modifying Jobs

3.5.1 Calling Up a Job

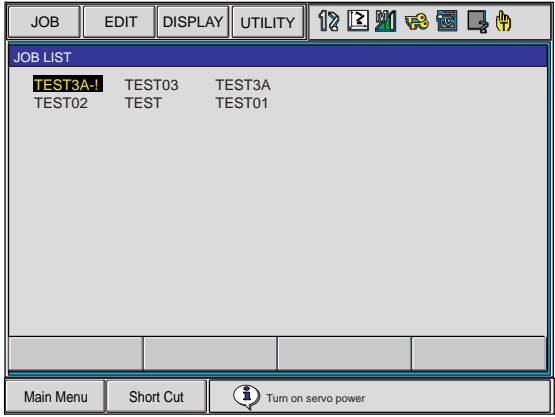
	Operation	Explanation
1	Select {JOB} under the main menu.	
2	Select {SELECT JOB}.	The JOB LIST window appears. 
3	Select the desired job.	



3.5.2 Windows Related to Job

There are five types of job windows. Jobs can be checked and edited in these windows.

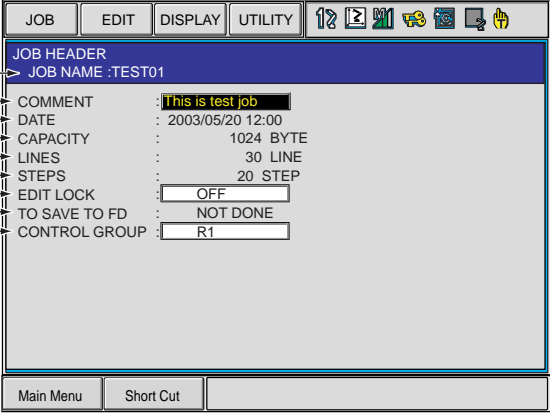

- **JOB HEADER Window**
Comments, data and time of registration, edit prohibit status, and so on are displayed and edited.
- **JOB CONTENT Window**
The content of the registered job can be displayed and edited.
- **COMMAND POSITION Window**
The taught data is displayed.
- **JOB LIST Window**
The registered job is sorted alphabetically, then displayed, and the job is selected.
- **JOB CAPACITY Window**
The number of registered jobs, amount of memory, number of steps used, etc. is shown.

■ JOB HEADER Window

	Operation	Explanation
1	Select {JOB} under the main menu.	
2	Select {JOB}.	

	Operation	Explanation
3	Select {DISPLAY} under the menu.	
4	Select {JOB HEADER}.	<p>The JOB HEADER window appears. Scroll the window using the cursor.</p>  <p>The screenshot shows a window titled 'JOB HEADER' with a menu bar containing 'JOB', 'EDIT', 'DISPLAY', and 'UTILITY'. Below the menu bar, the window displays the following information:</p> <ul style="list-style-type: none"> ① JOB NAME : TEST01 ② COMMENT : This is test job ③ DATE : 2003/05/20 12:00 ④ CAPACITY : 1024 BYTE ⑤ LINES : 30 LINE ⑥ STEPS : 20 STEP ⑦ EDIT LOCK : OFF ⑧ TO SAVE TO FD : NOT DONE ⑨ CONTROL GROUP : R1 <p>At the bottom of the window, there are buttons for 'Main Menu' and 'Short Cut'.</p> <p>① JOB NAME Displays the name of the current job.</p> <p>② COMMENT Displays the comments attached to the current job. This can be edited in this window.</p> <p>③ DATE Displays the date and time of the last editing of the job.</p> <p>④ CAPACITY Displays the amount of memory that is being used to register this job.</p> <p>⑤ LINES Displays the total number of instructions registered in this job.</p> <p>⑥ STEPS Displays the total number of move instructions registered in this job.</p> <p>⑦ EDIT LOCK Displays whether the edit prohibit setting for this job is at ON or OFF. This can be changed in this window.</p> <p>⑧ TO SAVE TO FD Displays "DONE" if the contents of the job are saved to a floppy disk since the date and time of the last editing operation, and displays "NOT DONE" if they are not saved. The job is marked as "DONE" only if it is saved as an independent job or as a related job. If it is saved in a CMOS batch operation, it is not marked as "DONE."</p> <p>⑨ CONTROL GROUP Displays the control group that this job controls. If the master axis is specified, the master axis is highlighted.</p> <div style="border: 1px solid black; padding: 5px; margin-top: 10px;">  To return to the JOB CONTENT window from the JOB HEADER window, select {DISPLAY} from the menu and then select {JOB CONTENT}. </div>

■ JOB CONTENT Window

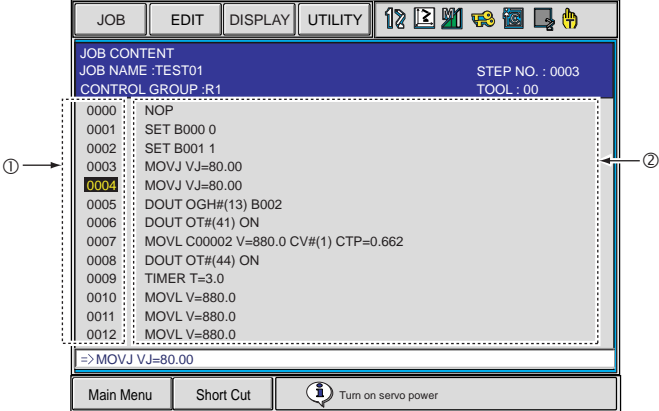
	Operation	Explanation
1	Select {JOB} under the main menu.	
2	Select {JOB}.	<p>The JOB CONTENT window appears.</p> <p>  ← (Left) : The cursor is moved to the address area. </p> <p>  → (Right): The cursor is moved to the instruction area. </p>  <p> ① Address Area Displays line numbers. </p> <p> ② Instruction Area Displays instructions, additional items, and comments. Line editing is possible. </p>

■ COMMAND POSITION Window

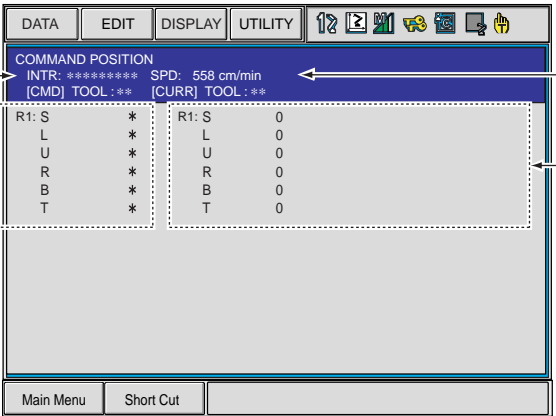
	Operation	Explanation																																																																								
1	Select {ROBOT} under the main menu.																																																																									
2	Select {COMMAND POSITION}.	<p>Edit operations cannot be conducted from this window, but the taught play speed and position data can be viewed on this window.</p>  <p>The screenshot shows the COMMAND POSITION window with the following data:</p> <table border="1" data-bbox="710 526 1268 940"> <tr> <td colspan="2">DATA</td> <td colspan="2">EDIT</td> <td colspan="2">DISPLAY</td> <td colspan="2">UTILITY</td> </tr> <tr> <td colspan="4">COMMAND POSITION</td> <td colspan="4">SPD: 558 cm/min</td> </tr> <tr> <td colspan="4">INTR: *****</td> <td colspan="4">[CMD] TOOL: **</td> </tr> <tr> <td colspan="4">R1: S *</td> <td colspan="4">R1: S 0</td> </tr> <tr> <td colspan="4">L *</td> <td colspan="4">L 0</td> </tr> <tr> <td colspan="4">U *</td> <td colspan="4">U 0</td> </tr> <tr> <td colspan="4">R *</td> <td colspan="4">R 0</td> </tr> <tr> <td colspan="4">B *</td> <td colspan="4">B 0</td> </tr> <tr> <td colspan="4">T *</td> <td colspan="4">T 0</td> </tr> </table> <p>① Interpolation Displays the interpolation type.</p> <p>② Speed Displays the play speed.</p> <p>③ Command Position Displays the tool file number and position data that has been taught for this job. Steps which have no position data, such as move instructions which use position variables, are marked with an asterisk (*).</p> <p>④ Current Data Displays the current tool file number and position of the manipulator.</p>	DATA		EDIT		DISPLAY		UTILITY		COMMAND POSITION				SPD: 558 cm/min				INTR: *****				[CMD] TOOL: **				R1: S *				R1: S 0				L *				L 0				U *				U 0				R *				R 0				B *				B 0				T *				T 0			
DATA		EDIT		DISPLAY		UTILITY																																																																				
COMMAND POSITION				SPD: 558 cm/min																																																																						
INTR: *****				[CMD] TOOL: **																																																																						
R1: S *				R1: S 0																																																																						
L *				L 0																																																																						
U *				U 0																																																																						
R *				R 0																																																																						
B *				B 0																																																																						
T *				T 0																																																																						

■ JOB CAPACITY Window

	Operation	Explanation
1	Select {JOB} under the main menu.	
2	Select {JOB CAPACITY}.	<div data-bbox="759 445 1315 857" style="border: 1px solid black; padding: 5px;"> </div> <p data-bbox="667 882 963 913">① NUMBER OF JOBS Displays the total number of jobs currently registered in the memory of NX100.</p> <p data-bbox="667 990 916 1021">② USED MEMORY Displays the total amount of memory used in the NX100.</p> <p data-bbox="667 1066 791 1097">③ STEPS Displays the total number of used steps.</p> <p data-bbox="667 1137 948 1169">④ EDITING BUFFER Displays editing buffer use.</p>

3.6 Editing Instructions

The content of editing differs depending on where the cursor is in the address area or instruction area.

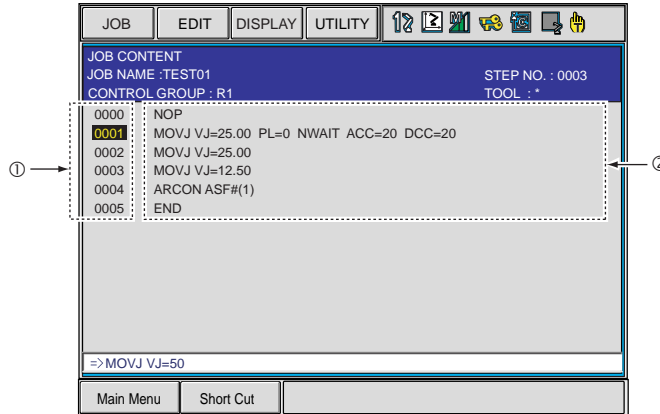

① When the cursor is in the address area

Instructions can be inserted, deleted, or modified.

② When the cursor is in the instruction area

Date of additional items of already-registered instructions can be modified, inserted, or deleted.

Editing additional items only is called “line editing.”

When inserting or modifying instructions, input the instruction with the function keys such as [TIMER], etc. or using the instruction list dialog box. The selected instruction is displayed on the input buffer line with the same additional items as registered previously.

3.6.1 Instruction Group

The instructions are divided into eight groups by processing or each work.

By pressing [INFORM LIST] , the instruction group list dialog box appears.

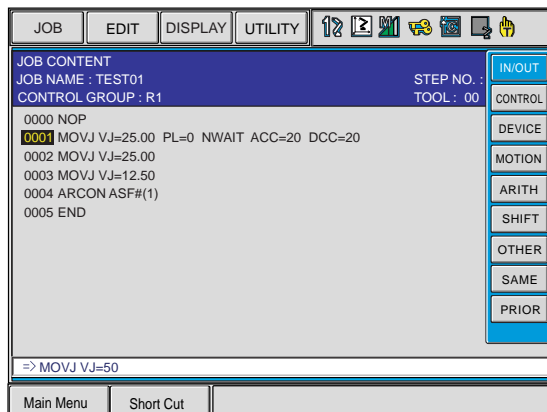



Display	Instruction Group	Contents	Example
IN/OUT	I/O Instructions	Controls input and output	DOUT, WAIT
CONTROL	Control Instructions	Controls processing or each work	JUMP, TIMER
DEVICE	Work Instructions	Operates arc welding, spot welding, handling, painting, etc.	ARCON, WVON, SVSPOT, SPYON
MOTION	Move Instructions	Moves the manipulator	MOVJ, REFP
ARITH	Operating Instructions	Performs arithmetic calculation	ADD, SET
SHIFT	Shift Instructions	Shifts the teaching point	SFTON, SFTOF
SENS (Option)	Sensor Instructions (Option)	Instructions related to the sensor	COMARCON
OTHER	Other Instructions	Instructions for functions other than above	SHCKSET
SAME	-	Specifies the instruction where the cursor is.	
PRIOR	-	Specifies the previously-registered instruction.	

By selecting a group, the instruction list dialog box of the selected group appears.

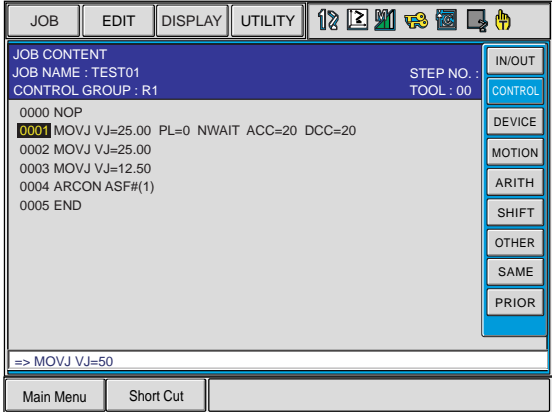
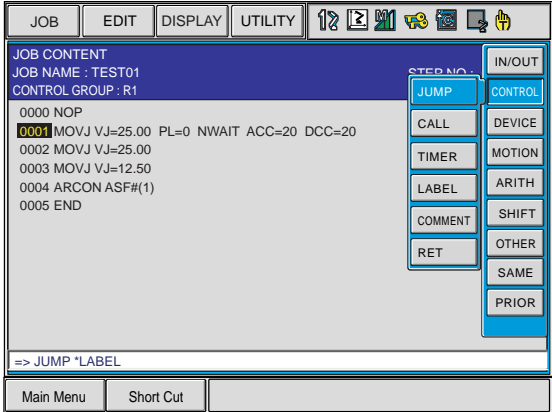

3.6.2 Inserting Instructions

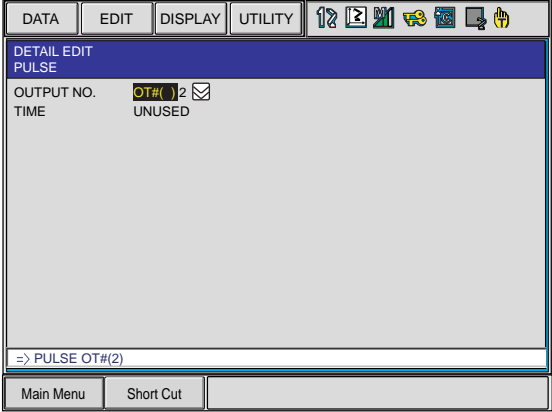
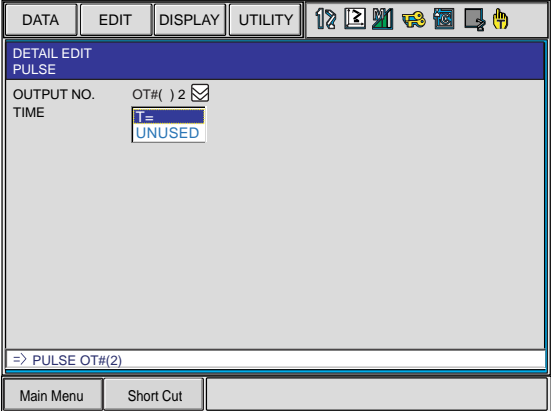

	Operation	Explanation
1	Move the cursor to the address area in the JOB CONTENT window.	<p>Move the cursor to the line immediately before where the instruction is to be inserted, in the teach mode.</p> <div style="border: 1px solid gray; padding: 5px; margin-top: 10px;"> <p>Line before where instruction is to be added. →</p> <pre> 0000 NOP 0001 MOVJ VJ=25.00 PL=0 NWAIT ACC=20 DCC=20 0002 MOVJ VJ=25.00 </pre> </div>
2	Press [INFORM LIST].	<p>The INFORM command list appears, and an underline is displayed beneath the line number in the address area.</p> 
3	Select the instruction group.	<p>The instruction list dialog box appears. The selected instruction is displayed on the input buffer line with the same additional items as registered previously.</p> 
4	Select the instruction.	

	Operation	Explanation
5	Change the data of additional items or variables as required.	<p><When Nothing is to be Changed> Proceed to Step 6.</p> <p><When Additional Items are to be edited></p> <ul style="list-style-type: none"> Changing numeric data Move the cursor to the desired item and press [SHIFT] + the cursor key to increase or decrease the value.  To directly input the value using Numeric keys, press [SELECT] to display the input buffer line.  Type the value and press [ENTER]. The value on the input buffer line is changed. Adding, modifying, or deleting an item To add, modify, or delete an additional item, move the cursor to the instruction on the input buffer line and press [SELECT]. The DETAIL EDIT window appears.  To add an item, move the cursor to "UNUSED" and press [SELECT]. The selection dialog box appears. Move the cursor to the desired item and press [SELECT]. To delete an item, move the cursor to the item to be deleted and select "UNUSED." 

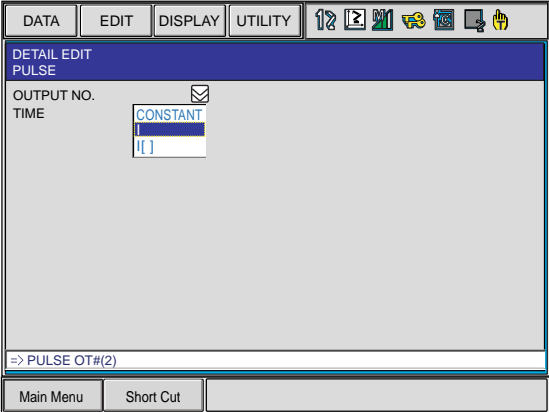
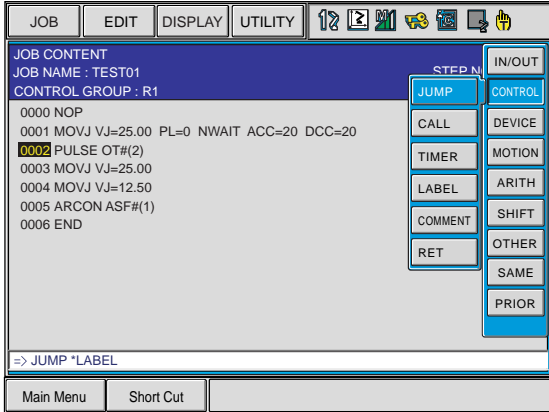
3.6 Editing Instructions

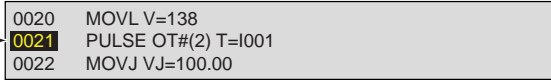

	Operation	Explanation
5	(cont'd)	<ul style="list-style-type: none"> • Changing the data type <p>To change the data type of an additional item, move the cursor to  of the item and press [SELECT]. The data type list appears. Select the desired data type.</p>  <p>After additional items have been added, modified, or deleted as required, press [ENTER]. The DETAIL EDIT window closes and the JOB CONTENT window appears.</p>
6	Press [INSERT] and [ENTER].	<p>The instruction displayed in the input buffer line is inserted. When adding immediately before the END instruction, pressing [INSERT] is not needed.</p> 

3.6.3 Deleting Instructions

	Operation	Explanation
1	Move the cursor to the address area in the JOB CONTENT window.	Move the cursor to the instruction line to be deleted, in the teach mode.
2	Move the cursor to the deleting line in the address area.	<p>The line desired to be deleted</p>  <pre> 0020 MOVL V=138 0021 PULSE OT#(2) T=I001 0022 MOVJ VJ=100.00 </pre>
3	Press [DELETE] and [ENTER].	<p>The instruction is deleted and the following lines move up.</p>  <pre> 0021 MOVL V=138 0022 MOVJ VJ=100.00 0023 DOUT OT#(1) ON </pre>

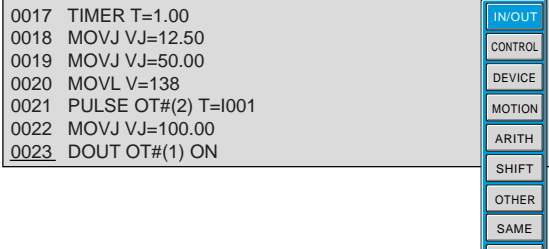
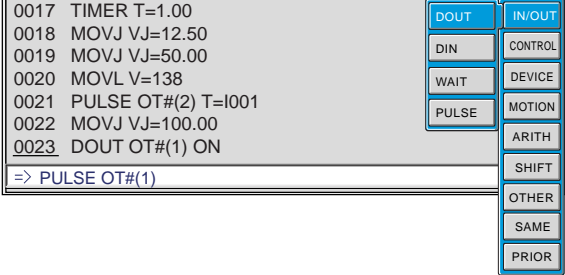
3.6.4 Modifying Instructions

	Operation	Explanation
1	Move the cursor to the address area in the JOB CONTENT window.	<p>Move the cursor to the instruction line to be modified, in the teach mode.</p>  <pre> 0022 MOVJ VJ=100.00 0023 DOUT OT#(1) ON 0024 MOVJ VJ=50.00 </pre>
2	Press [INFORM LIST].	<p>The INFORM command list appears, and an underline is displayed beneath the line number in the address area.</p>  <pre> 0017 TIMER T=1.00 0018 MOVJ VJ=12.50 0019 MOVJ VJ=50.00 0020 MOVL V=138 0021 PULSE OT#(2) T=I001 <u>0022</u> MOVJ VJ=100.00 0023 DOUT OT#(1) ON </pre>
3	Select the instruction group.	<p>The instruction list dialog box appears. The selected instruction is displayed on the input buffer line with the same additional items as registered previously.</p>  <pre> 0017 TIMER T=1.00 0018 MOVJ VJ=12.50 0019 MOVJ VJ=50.00 0020 MOVL V=138 0021 PULSE OT#(2) T=I001 0022 MOVJ VJ=100.00 <u>0023</u> DOUT OT#(1) ON => PULSE OT#(1) </pre>
4	Select the instruction to be modified.	

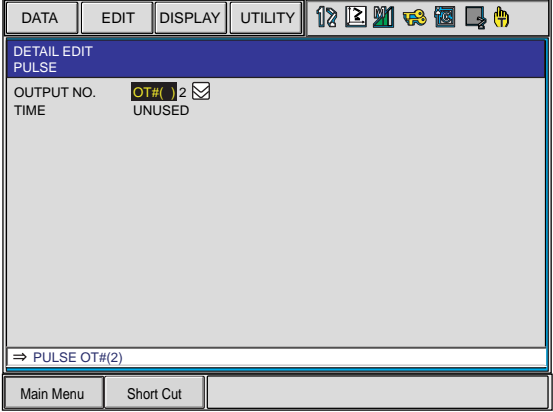
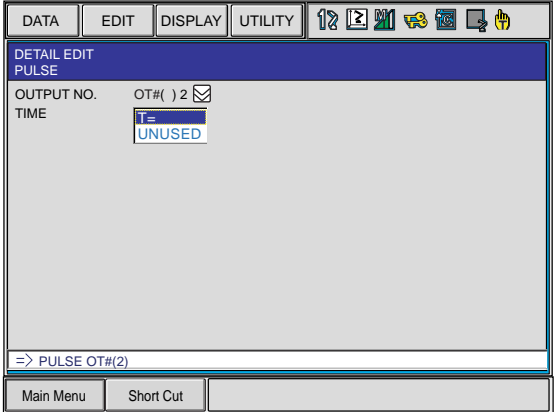
	Operation	Explanation
5	Change the data of additional items or variables as required.	<p><Editing Additional Items></p> <ul style="list-style-type: none"> Changing numeric data Move the cursor to the desired item and press [SHIFT] + the cursor key to increase or decrease the value.  To directly input the value using Numeric keys, press [SELECT] to display the input buffer line.  Type the value and press [ENTER]. The value on the input buffer line is changed. Adding, modifying, or deleting an item To add, modify, or delete an additional item, move the cursor to the instruction on the input buffer line and press [SELECT]. The DETAIL EDIT window appears.  To add an item, move the cursor to “UNUSED” and press [SELECT]. The selection dialog box appears. Move the cursor to the desired item and press [SELECT]. To delete an item, move the cursor to the item to be deleted and select “UNUSED.” 

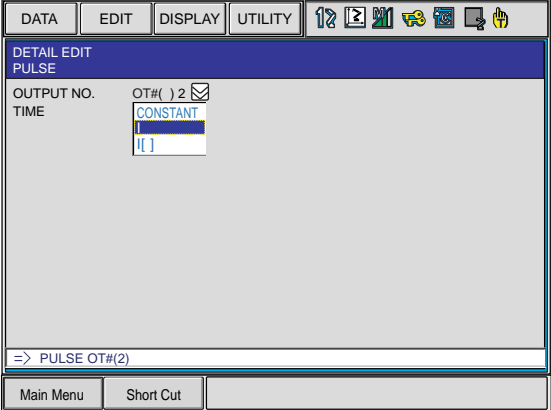
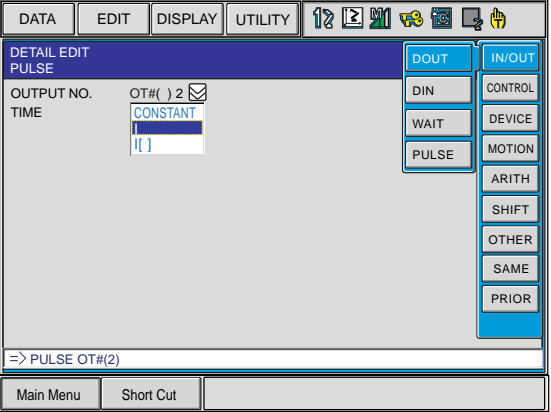
	Operation	Explanation
5	(cont'd)	<ul style="list-style-type: none"> • Changing the data type <p>To change the data type of an additional item, move the cursor to  of the item and press [SELECT]. The data type list appears. Select the desired data type.</p>  <p>After additional items have been added, modified, or deleted as required, press [ENTER]. The DETAIL EDIT window closes and the JOB CONTENT window appears.</p>
6	Press [MODIFY] and [ENTER].	<p>The instruction is modified to the instruction displayed in the input buffer line.</p> 



3.6.5 Modifying Additional Numeric Data

	Operation	Explanation
1	Move the cursor to the instruction area in the JOB CONTENT window.	
2	Select the line where the number data is to be modified.	<p>The selected line can now be edited.</p> <div style="border: 1px solid black; padding: 5px; width: fit-content;"> <pre> 0017 TIMER T=1.00 0018 MOVJ VJ=12.50 0019 MOVJ VJ=50.00 0020 MOVL V=138 0021 PULSE OT#(2) T=I001 0022 MOVJ VJ=100.00 0023 DOUT OT#(1) ON </pre> <p>Number data to be modified →</p> </div>
3	Move the cursor to the numeric data to be modified.	
4	Input the desired number.	<p>Press [SHIFT] + the cursor key to increase or decrease the value. To directly input the number, press [SELECT]. The input buffer line appears. Type the number and press [ENTER].</p> <div style="border: 1px solid black; padding: 2px; width: fit-content; margin: 10px auto;"> <p>⇒PULSE OT#(2) T=I001</p> </div>
5	Press [ENTER].	<p>The numeric data is modified.</p> <div style="border: 1px solid black; padding: 5px; width: fit-content;"> <pre> 0017 TIMER T=1.00 0018 MOVJ VJ=12.50 0019 MOVJ VJ=50.00 0020 MOVL V=138 0021 PULSE OT#(1) T=I001 0022 MOVJ VJ=100.00 0023 DOUT OT#(1) ON </pre> <p>Instruction line for which numeric data was changed. →</p> </div>

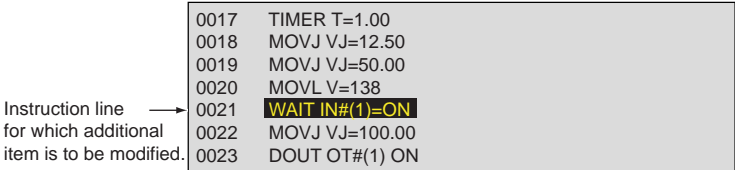
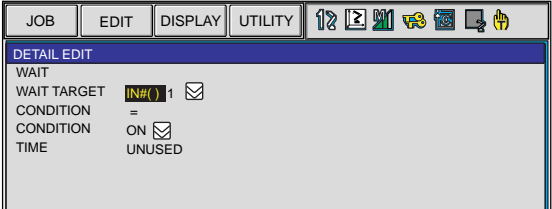
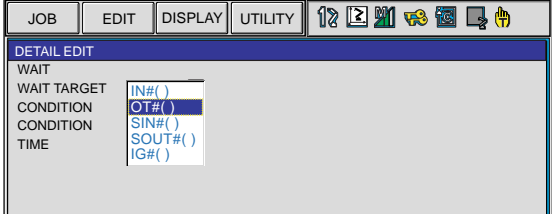
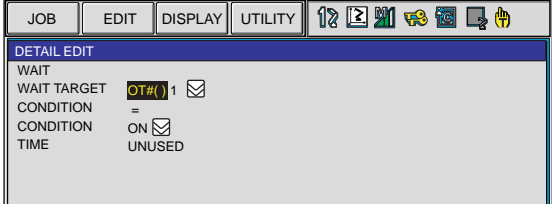
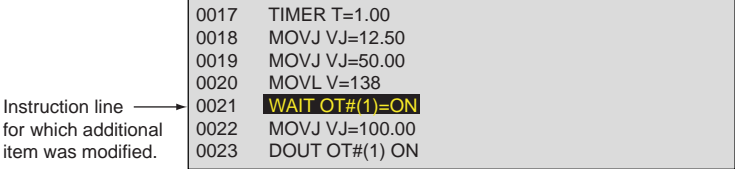
3.6.6 Modifying Additional Items

	Operation	Explanation
1	Move the cursor to the instruction area in the JOB CONTENT window.	
2	Select the instruction line for which the additional item is to be modified.	<p>The selected line can now be edited.</p>  <pre> 0017 TIMER T=1.00 0018 MOVJ VJ=12.50 0019 MOVJ VJ=50.00 0020 MOVL V=138 0021 WAIT IN#(1)=ON 0022 MOVJ VJ=100.00 0023 DOUT OT#(1) ON </pre>
3	Select the instruction.	<p>The DETAIL EDIT window appears.</p> 
4	Select the additional item to be modified.	<p>The selection dialog box appears.</p> 
5	Select the desired additional item.	<p>The modified additional item is displayed on the DETAIL EDIT window.</p> 
6	Press [ENTER].	<p>The DETAIL EDIT window closes, and the JOB CONTENT window appears.</p>
7	Press [ENTER].	<p>Contents of the input buffer line are registered on the cursor line of the instruction area.</p>  <pre> 0017 TIMER T=1.00 0018 MOVJ VJ=12.50 0019 MOVJ VJ=50.00 0020 MOVL V=138 0021 WAIT OT#(1)=ON 0022 MOVJ VJ=100.00 0023 DOUT OT#(1) ON </pre>

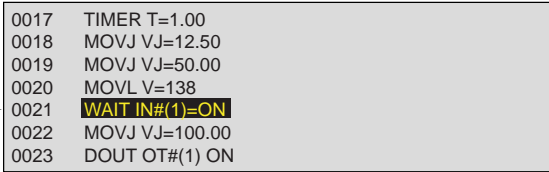
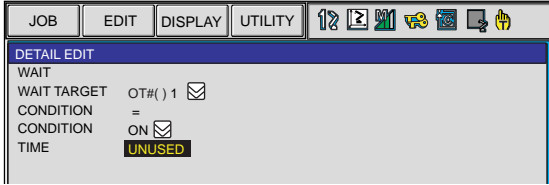
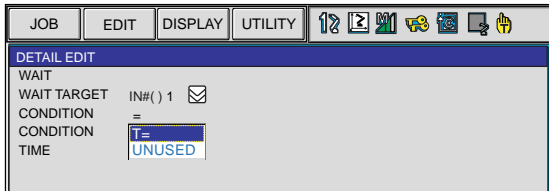
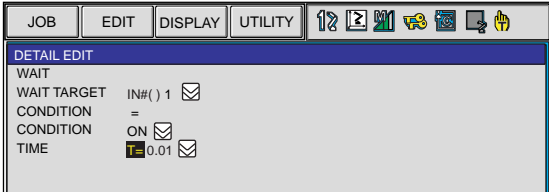
3.6.7 Inserting Additional Items

	Operation	Explanation
1	Move the cursor to the instruction area in the JOB CONTENT window.	
2	Select the instruction line for which the additional item is to be inserted.	<p>The selected line can now be edited.</p>  <p>Instruction line → for which additional item is to be added.</p> <pre> 0017 TIMER T=1.00 0018 MOVJ VJ=12.50 0019 MOVJ VJ=50.00 0020 MOVL V=138 0021 WAIT IN#(1)=ON 0022 MOVJ VJ=100.00 0023 DOUT OT#(1) ON </pre>
3	Select the instruction.	<p>The DETAIL EDIT window appears.</p> 
4	Select the additional item to be inserted.	<p>The selection dialog box appears.</p> 
5	Select inserting additional item.	<p>The additional item is inserted.</p>  <p>When the additional item needs the numeric data, move the cursor to the number and press [SELECT]. The input buffer line appears. Type the number and press [ENTER].</p> 
6	Press [ENTER].	<p>The DETAIL EDIT window closes, and the JOB CONTENT window appears.</p>
7	Press [ENTER].	<p>Contents of the input buffer line are registered on the cursor line of the instruction area.</p>  <p>Instruction line → for which additional item was added.</p> <pre> 0017 TIMER T=1.00 0018 MOVJ VJ=12.50 0019 MOVJ VJ=50.00 0020 MOVL V=138 0021 WAIT IN#(1)=ON T=0.50 0022 MOVJ VJ=100.00 0023 DOUT OT#(1) ON </pre>

3.6.8 Deleting Additional Items

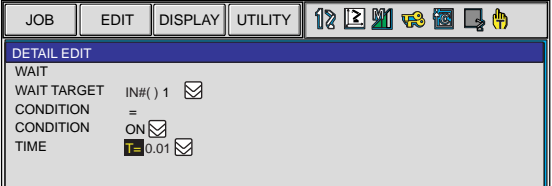
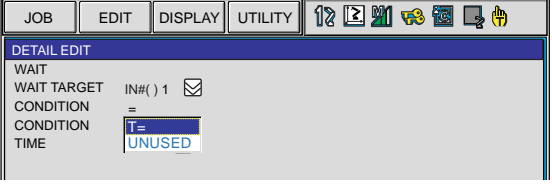
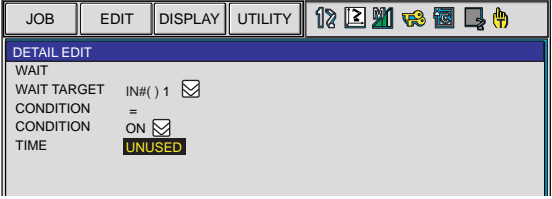
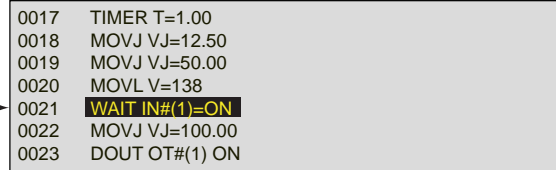

This operation cannot be used for the additional item which is locked.

	Operation	Explanation
1	Move the cursor to the instruction area in the JOB CONTENT window.	
2	Select the line where the additional item is to be deleted.	<p>The selected line can be now be edited.</p>  <pre> 0017 TIMER T=1.00 0018 MOVJ VJ=12.50 0019 MOVJ VJ=50.00 0020 MOVL V=138 0021 WAIT IN#(1)=ON T=1.00 0022 MOVJ VJ=100.00 0023 DOUT OT#(1) ON </pre>
3	Select the instruction.	<p>The DETAIL EDIT window appears.</p> 
4	Select the additional item to be deleted.	<p>The selection dialog box appears.</p> 
5	Select "UNUSED."	<p>"UNUSED" is displayed on the DETAIL EDIT window.</p> 
6	Press [ENTER].	<p>The DETAIL EDIT window closes, and the JOB CONTENT window appears.</p>
7	Press [ENTER].	<p>Contents of the input buffer line are registered on the cursor line of the instruction area.</p>  <pre> 0017 TIMER T=1.00 0018 MOVJ VJ=12.50 0019 MOVJ VJ=50.00 0020 MOVL V=138 0021 WAIT IN#(1)=ON 0022 MOVJ VJ=100.00 0023 DOUT OT#(1) ON </pre>

3.7 Editing Jobs

The following five operations are to edit jobs.

- Copy** :Copies a specified range to the buffer.
- Cut** :Copies a specified range from a job to the buffer, and deletes it in a job.
- Paste** :Inserts the contents of the buffer into a job.
- Reverse Paste** :Reverses the order of the contents of the buffer, and inserts them into a job. (Refer to the following figure.)
- Base Reverse Paste** :Reverses the order of the contents of the buffer and adjusts the to-and-from speeds same, and inserts them into a job. (Refer to the following figure.)

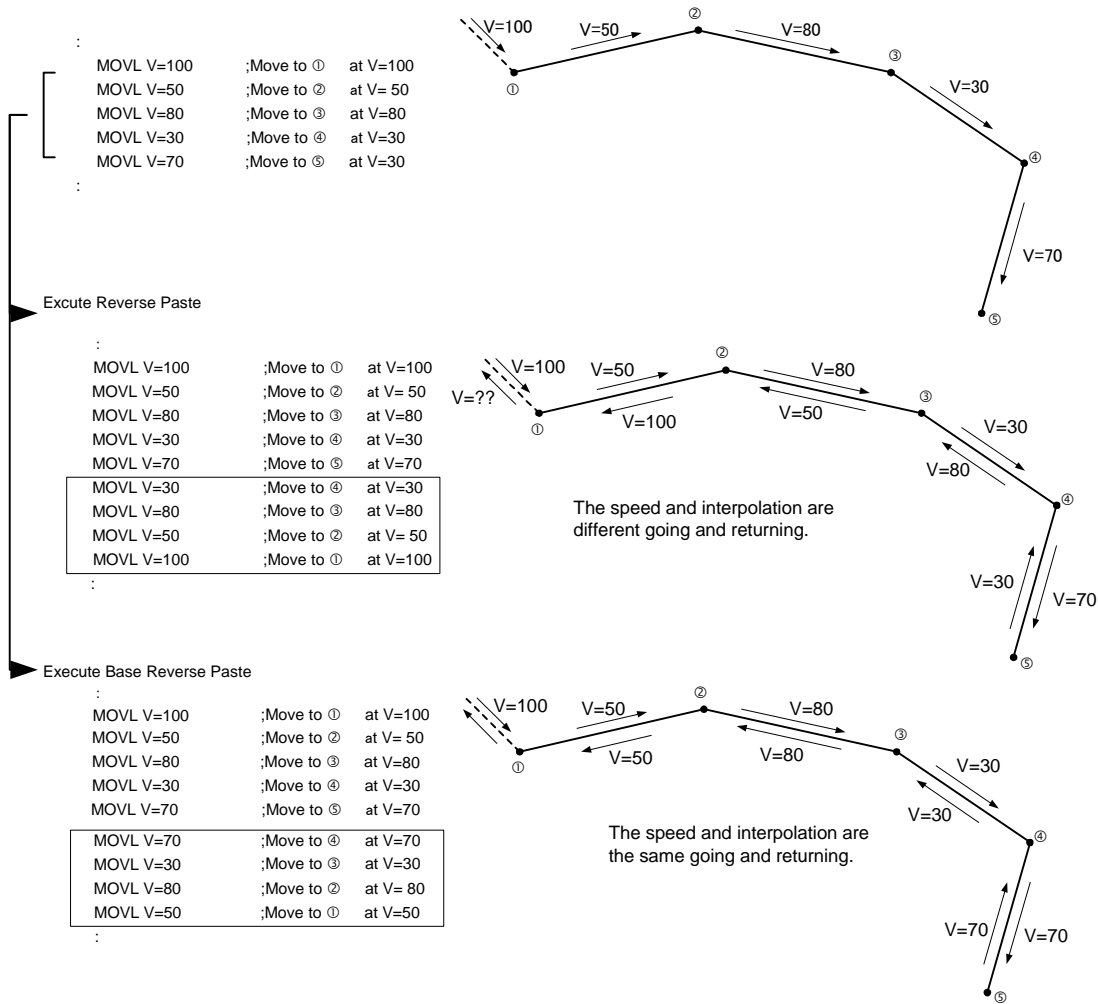

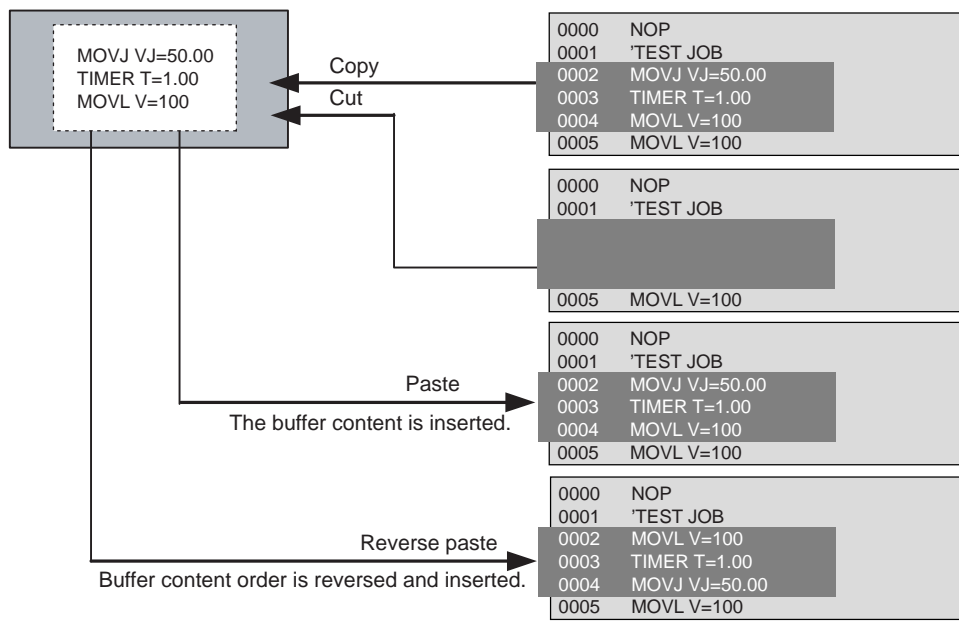

3.7.1 Selecting the Range

After setting the range, Copy and Delete can be performed.

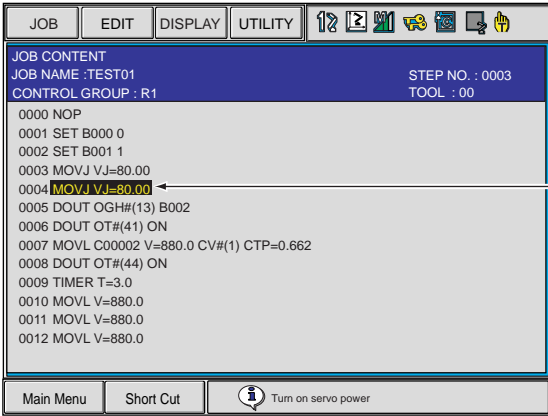
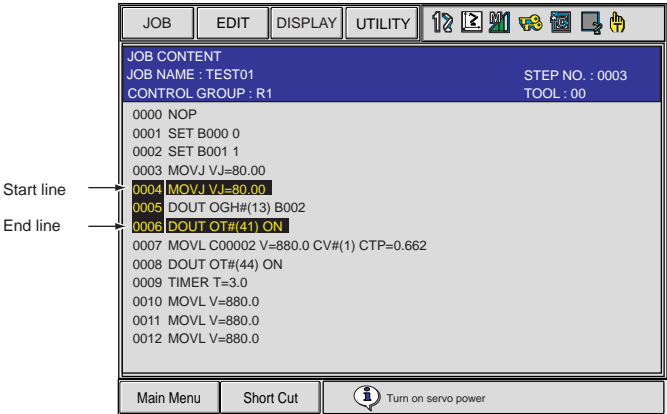
	Operation	Explanation
1	Move the cursor to the instruction area in the JOB CONTENT window.	 <p>The screenshot shows the 'JOB CONTENT' window with a menu bar (JOB, EDIT, DISPLAY, UTILITY) and a toolbar. The job name is TEST01, step number is 0003, and control group is R1. The instruction list includes: 0000 NOP, 0001 SET B000 0, 0002 SET B001 1, 0003 MOVJ VJ=80.00, 0004 MOVJ VJ=80.00 (highlighted with a cursor), 0005 DOUT OGH#(13) B002, 0006 DOUT OT#(41) ON, 0007 MOVL C00002 V=880.0 CV#(1) CTP=0.662, 0008 DOUT OT#(44) ON, 0009 TIMER T=3.0, 0010 MOVL V=880.0, 0011 MOVL V=880.0, and 0012 MOVL V=880.0. A text label 'Move the cursor to instruction area.' points to the highlighted line.</p>
2	Move the cursor to the start line and press [SHIFT] + [SELECT].	<p>The range specification begins, and the address is displayed in reverse.</p>  <p>The screenshot shows the same 'JOB CONTENT' window. Lines 0004 and 0006 are highlighted in yellow. Brackets on the left indicate the 'Start line' at 0004 and the 'End line' at 0006. The instruction list is the same as in the previous screenshot.</p>
3	Move the cursor to the end line.	<p>Moving the cursor effects to the range. Up to the line specified by the cursor is the range.</p>

3.7.2 Copying

Before copying, the range to be copied has to be specified.

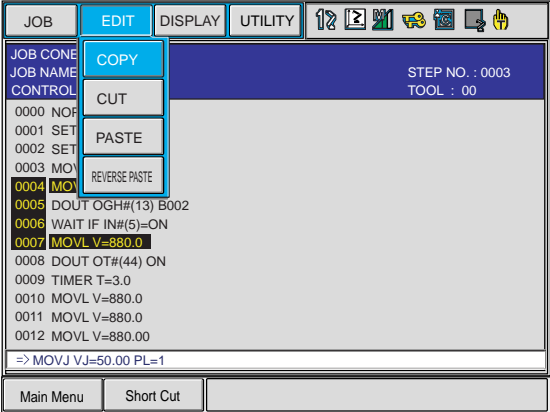
	Operation	Explanation
1	Select {EDIT} under the menu.	The pull-down menu appears. 
2	Select {COPY}.	The specified range is copied to the buffer.

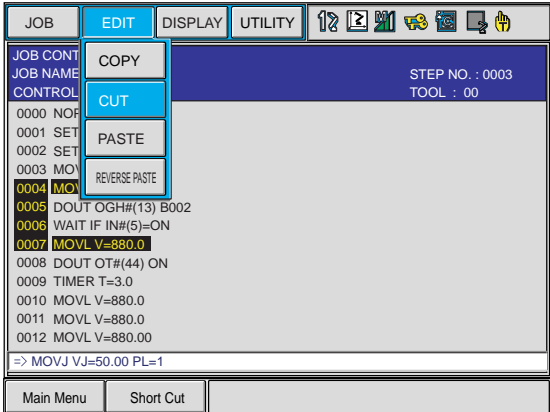
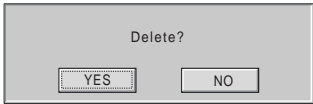

3.7.3 Cutting

Before cutting, the range to be cut has to be specified.

	Operation	Explanation
1	Select {EDIT} under the menu.	The pull-down menu appears. 
2	Select {CUT}.	The confirmation dialog box appears. When "YES" is selected, the specified range is deleted and copied to the buffer. When "NO" is selected, the cutting operation is cancelled. 

3.7.4 Pasting

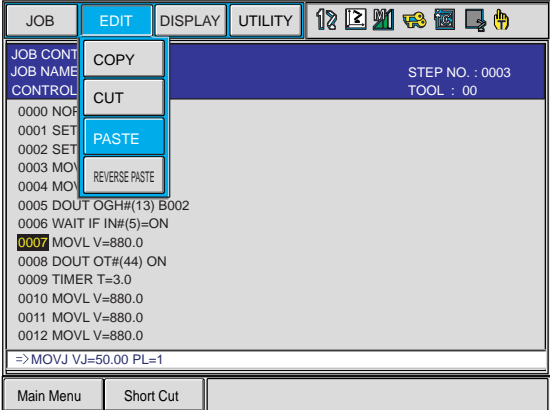
Before pasting, the range to be pasted has to be stored in the buffer.

	Operation	Explanation
1	Move the cursor to the line immediately before the desired position in the JOB CONTENT window.	
2	Select {EDIT} under the menu.	<p>The pull-down menu appears.</p> 
3	Select {PASTE}.	<p>The confirmation dialog box appears. When “YES” is selected, the contents of the buffer are inserted to the job. When “NO” is selected, the pasting operation is cancelled.</p> 

3.7.5 Reverse Pasting

Before pasting, the range to be pasted has to be stored in the buffer.

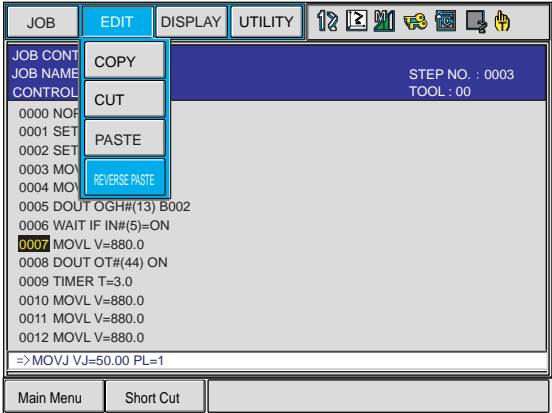
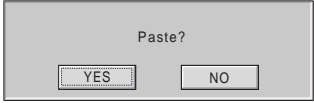
	Operation	Explanation
1	Move the cursor to the line immediately before the desired position in the JOB CONTENT window.	
2	Select {EDIT} under the menu.	<p>The pull-down menu appears.</p>  <p>The screenshot shows a window titled 'JOB CONTENT' with a menu bar containing 'JOB', 'EDIT', 'DISPLAY', and 'UTILITY'. The 'EDIT' menu is open, showing options: 'COPY', 'CUT', 'PASTE', and 'REVERSE PASTE'. The 'REVERSE PASTE' option is highlighted. The main window displays a list of job steps, with step 0007 highlighted: '0007 MOV L V=880.0'. Other steps include '0000 NOF', '0001 SET', '0002 SET', '0003 MO', '0004 MO', '0005 DOUT OGH#(13) B002', '0006 WAIT IF IN#(5)=ON', '0008 DOUT OT#(44) ON', '0009 TIMER T=3.0', '0010 MOV L V=880.0', '0011 MOV L V=880.0', and '0012 MOV L V=880.0'. At the bottom, there are buttons for 'Main Menu' and 'Short Cut'.</p>
3	Select {REVERSE PASTE}.	<p>The confirmation dialog box appears. When “YES” is selected, the contents of the buffer are reverse pasted to the job. When “NO” is selected, the pasting operation is cancelled.</p>  <p>The screenshot shows a small dialog box titled 'Paste?' with two buttons: 'YES' and 'NO'.</p>

3.8 Test Operations

Playback operations can be simulated in the teach mode with test operations. This function is convenient for checking continuous paths and operation instructions.

Test operation differs in the following ways from actual playback in the play mode.

NOTE

- Operation speeds greater than the maximum teaching speed are reduced to the maximum teaching speed.
- Only machine lock is available among special operations for playback in the play mode.
- Work instruction output, such as arc output, is not executed.

Test operation is performed by pressing [INTERLOCK] and [TEST START]. For safety purposes, these keys will only function while the keys are held down.

NOTE

Always check safety conditions before starting the manipulator in motion.

	Operation	Explanation
1	Select {JOB} under the main menu.	
2	Press {JOB}.	The test operation JOB CONTENT window appears.
3	Press [INTERLOCK] + [TEST START].	The manipulator starts the test cycle operation. The manipulator moves only while these keys are held down. However, after the operation starts, the motion continues even if [INTERLOCK] is released. The manipulator stops immediately when [TEST START] is released.

3.9 Other Job-editing Functions

3.9.1 Editing Play Speed

There are two ways to modify play speed:

- Modification of Speed Type
- Relative Modification

■ Modification of Speed Type

This method is used to modify the speed type (such as VJ, V, VR, etc.).

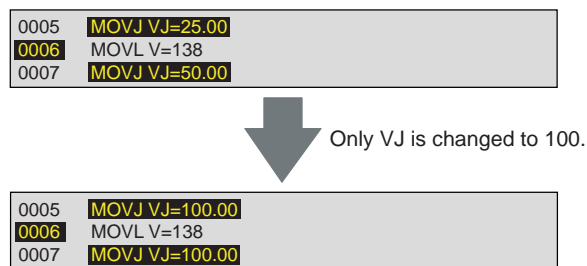

Type of Play Speed	Explanation	
VJ	Joint Speed	Normal robot axes
V	TCP Speed	
VR	Posture Angle Speed	
VE	Base Axis Speed	

■ Relative Modification

All steps are selected regardless of the play speed type. This method is used to change all steps by a specified percentage (1% to 200%). This is called relative modification.

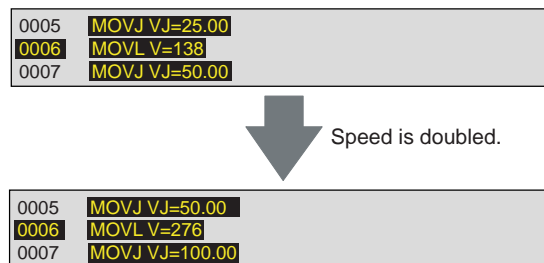

The speed of the entire job or specified section can be changed.

	Operation	Explanation
1	Select {JOB} under the main menu.	
2	Select {JOB}.	The JOB CONTENT window appears.

3.9 Other Job-editing Functions

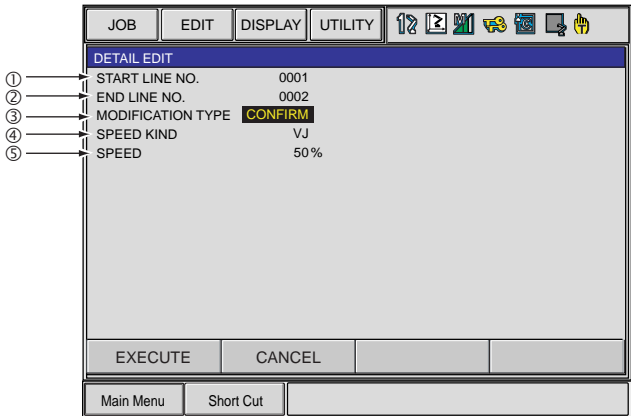
	Operation	Explanation
3	Move the cursor to the instruction area.	
4	Press [SHIFT] + [SELECT] in the speed modify start line.	If the section is not specified, the speed of the entire job will be changed.
5	Move the cursor to the end line.	The line numbers of the selected lines are highlighted.
6	Select {EDIT} under the menu.	
7	Select {CHANGE SPEED}.	The SPEED MODIFICATION window appears. 
8	Set desired items.	<p>① START LINE NO. Displays the first line number of the section to be modified.</p> <p>② END LINE NO. Displays the last line number of the section to be modified.</p> <p>③ MODIFICATION TYPE Selects the confirmation before changing: "CONFIRM" or "NO CONFIRM." Each time [SELECT] is pressed when the cursor is on this item, the setting alternates between "CONFIRM" and "NO CONFIRM."</p> <p>④ SPEED KIND Selects the speed type. When [SELECT] is pressed when the cursor is on this item, selection dialog box appears. Select the speed type to be changed.</p> <p>⑤ SPEED Specifies the speed value. When [SELECT] is pressed when the cursor is on this item, the mode changes to number input mode. Input the speed value and press [ENTER].</p>
9	Select "EXECUTE."	The speed begins to change. If "MODIFICATION TYPE" is set to "CONFIRM," the confirmation dialog box "Modifying speed" is displayed. Press [ENTER] to change the speed on the first line and search for the next speed. Press the UP/DOWN cursor button to keep the speed on the first line and search for the next speed. To cancel the speed modification, press [CANCEL]. If "MODIFICATION TYPE" is set to "NOT CONFIRM," all the speeds of the specified section are changed.

■ Modification by TRT (Traverse Time)

Modifications made by TRT have the following characteristics:

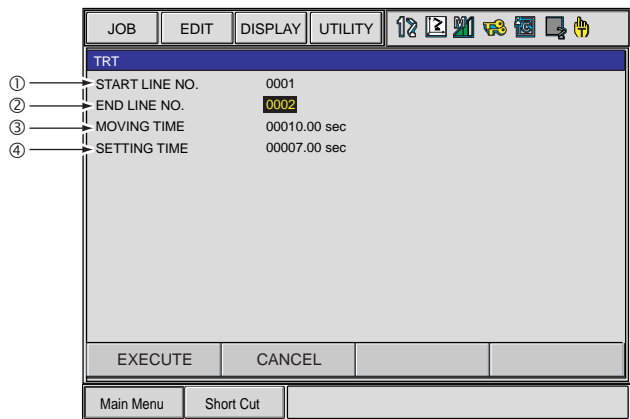

- By setting the time required to execute a move instruction (moving time) to a desired value, the speeds can be modified.
- It is possible to measure the moving time without actually moving the manipulator.

For example, when the movement from lines 5 through 20 currently requires 34 seconds, and you want to reduce it to 15 seconds or extend it to 50 seconds, this function is used.

	Operation	Explanation
1	Select {JOB} under the main menu.	
2	Select {JOB}.	The JOB CONTENT window appears.
3	Move the cursor to the instruction area.	
4	Press [SHIFT] + [SELECT] in the weaving time measure start line.	
5	Move the cursor to the end line.	The line numbers of the selected lines are highlighted.
6	Select {EDIT} under the menu.	
7	Select {TRT}.	The TRT window appears. 

	Operation	Explanation
8	Set the desired items.	<p>① START LINE NO. Displays the first line number of the section to be measured and modified.</p> <p>② END LINE NO. Displays the last line number of the section to be measured and modified.</p> <p>③ MOVING TIME The weaving time needed to move from the first number to last number is measured and displayed.</p> <p>④ SETTING TIME Set the desired weaving time. When [SELECT] is pressed when the cursor is on this item, the input buffer line appears. Input the desired weaving time and press [ENTER].</p>
9	Select "EXECUTE."	<p>The speed is changed according to the setting.</p> <div style="border: 1px solid black; padding: 10px;"> <p>NOTE</p> <ul style="list-style-type: none"> • If instructions that include specific speed data such as SPEED or ARCON instructions (including speed data of the welding condition file) exist in the specified section, the speed data for those steps are not changed. Therefore, in such cases, the set time and the actual time required are not same. • If the speed data is limited by the maximum value, the following message is displayed. <div style="border: 1px solid gray; padding: 5px; margin-top: 10px; text-align: center;">  !Limited to maximum speed </div> </div>

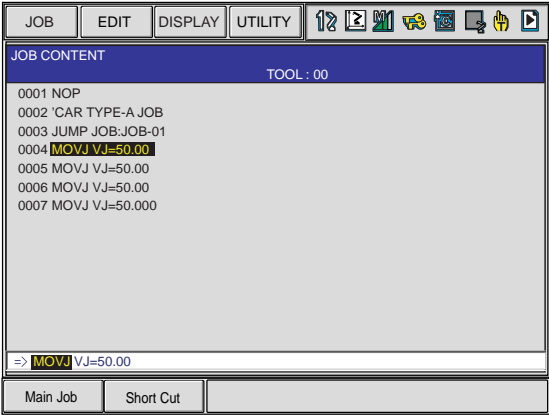
3.9.2 Editing Interpolation Type

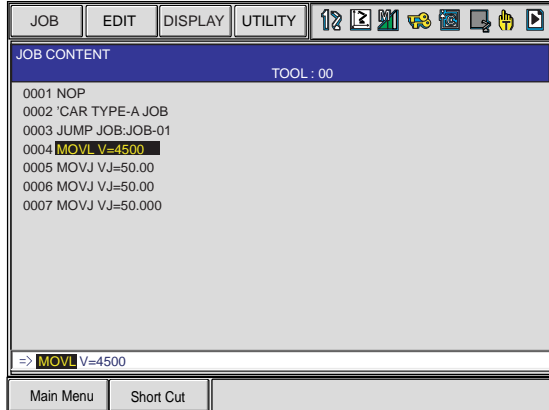
	Operation	Explanation
1	Select {JOB} under the main menu.	
2	Select {JOB}.	The JOB CONTENT window appears.
3	Move the cursor to the instruction area.	
4	Select the line to be modified.	<p>The instruction on the cursor is displayed in the input buffer line.</p> 
5	Press [SHIFT] + the cursor key simultaneously.	<p>The interpolation type in the input buffer line changes. The modification of the speed according to the modification of the interpolation type is calculated by the ratio to maximum speed at each speed.</p> <p>Joint Speed: MAX=100.0% Linear Speed: MAX=9000cm/min (e.g.) Joint Speed: 50% = Linear Speed: 4500cm/min Linear Speed: 10% = Linear Speed: 900cm/min</p> 
6	Press [ENTER].	<p>The instruction on the cursor line is replaced with one on the input buffer line.</p> 

3.9.3 Editing Condition Files

Condition files are prepared in order to set the conditions for the manipulator to execute instructions.

Multiple condition files are provided for each application. More than one pattern can be set up in each condition file. The patterns are listed by “condition numbers.” This number is specified by the work instruction in a job.



Refer to NX100 Operator's Manual of each application for information regarding the contents and editing methods of the condition file.

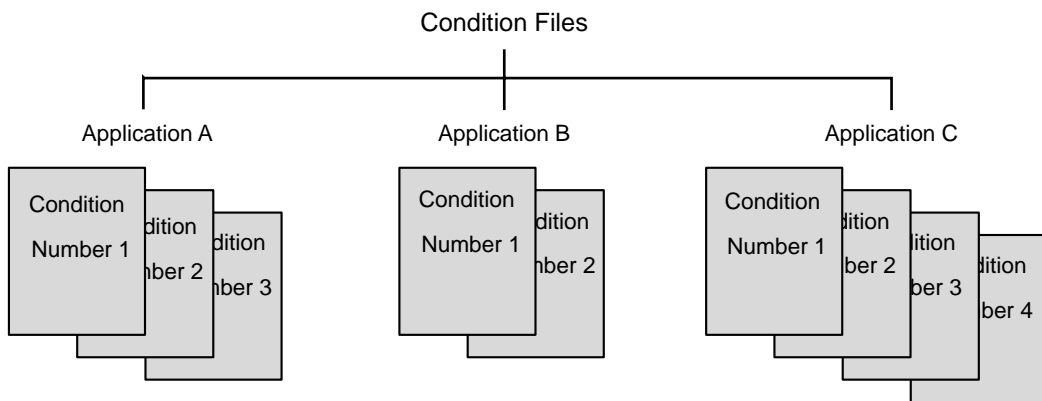

3.9.4 User Variables

User variables are used for jobs to store counters, calculation results or input signals. Since the same user variable can be used in multiple jobs, save the numerical values as common references for the jobs and the user variables are maintained even when the power is turned OFF.

User variables have the following applications:

- Controlling of the number of workpieces
- Controlling of the number of jobs
- Sending/receiving of information between jobs

The data formats for user variables are described in the following table:

User Variables

Data Format		Variable No. (pcs)	Functions
Byte Type		B000 to B099 (100)	Range of storable values is from 0 to 255. Can store I/O status. Can perform logical operations (AND, OR, etc.).
Integer Type		I000 to I099 (100)	Range of storable values is from -32768 to 32767.
Double Precision Integer Type		D000 to D099 (100)	Range of storable values is from -2147483648 to 2147483647.
Real Type		R000 to R099 (100)	Range of storable values is from -3.4E+38 to 3.4E38. Accuracy: $1.18E-38 < x \leq 3.4E38$
Character Type		S000 to S099 (100)	Maximum storable number of characters is 16.
Position Type	Robot Axes	P000 to P127 (128)	Can store position data in pulse form or in XYZ form. XYZ type variable can be used as target position data for move instructions, and as incremental values for parallel shift instructions.
	Base Axes	BP000 to BP127 (128)	
	Station Axes	EX000 to EX127 (128)	



• **Play Speed V:**

MOVL V=I000

The variable I000 is used for speed V with this move instruction.

The unit for V is 0.1mm per second.

For example, if I000 were set as 1000, the following would be true:

I000=1000 → unit for V is 0.1mm/s → V=100.0mm/s

Note that, depending on the unit being used, the value of the variable and the value of the actual speed on occasion might not match.

• **Play Speed VJ:**

MOVL VJ=I000

The unit for VJ is 0.01%.

For example, if I000 were set as 1000, the following would be true:

I000=1000 → unit for VJ is 0.01% → VJ=10.00%.

• **Timer T:**

TIMER T=I000

The unit for T is 0.01 seconds.

For example, if I000 were set as 1000, the following would be true:

I000=1000 → unit for T is 0.01 seconds → T=10.00 seconds.

■ Setting Byte, Integer, Double Precision Integer, and Real Type Variables

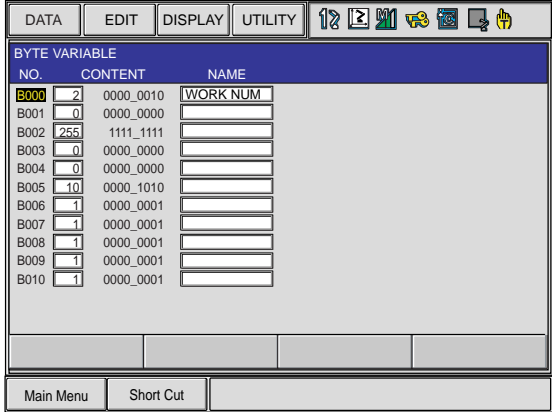
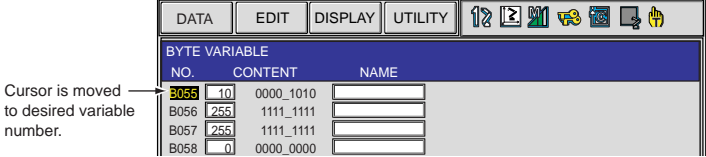
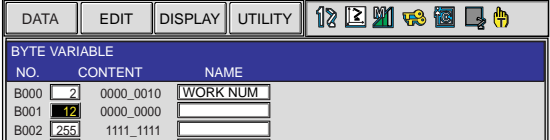
	Operation	Explanation
1	Select {VARIABLE} under the main menu.	{BYTE}, {INTEGER}, {DOUBLE}, and {REAL} are displayed for the sub menu.
2	Select desired variable type.	<p>The BYTE VARIABLE window appears. (Following is a case that {BYTE} is selected.)</p> 
3	Move the cursor to the desired variable No.	<p>When the desired variable number is not displayed, move the cursor with either of the following operations.</p> <ul style="list-style-type: none"> • Move the cursor on the variable No. and press [SELECT]. Then input the variable No. using the Numeric keys and press [ENTER]. • Move the cursor to the menu area and select {EDIT} → {SEARCH}. Then input the variable No. with the Numeric keys and press [ENTER]. 
4	Move the cursor to the data of the variable.	
5	Press [SELECT].	The number can be directly typed.
6	Input the desired number.	
7	Press [ENTER].	<p>Input value is set to the variable on the cursor position.</p> 



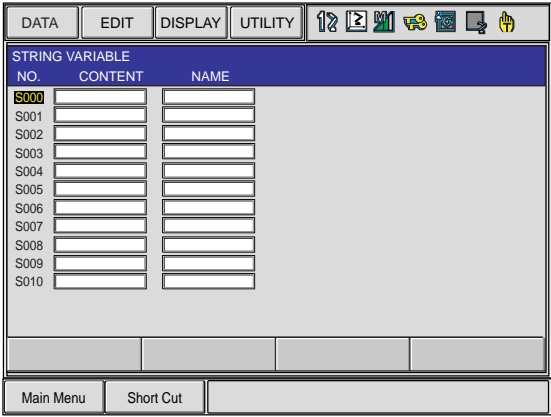
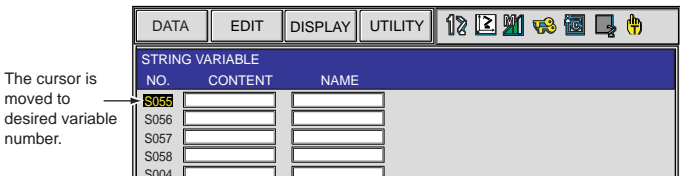
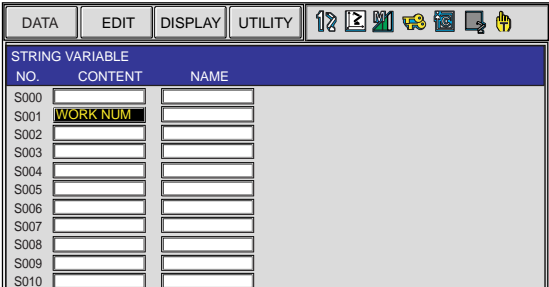

■ Setting Character Type Variables

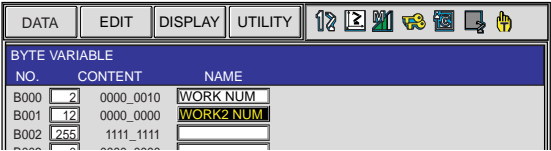
	Operation	Explanation
1	Select {VARIABLE} under the main menu.	
2	Select {STRING}.	<p>The STRING VARIABLE window appears.</p> 
3	Move the cursor to the desired variable No.	<p>When the desired variable number is not displayed, move the cursor with either of the following operations.</p> <ul style="list-style-type: none"> • Move the cursor on the variable No. and press [SELECT]. Then input the variable No. using the Numeric keys and press [ENTER]. • Move the cursor to the menu area and select {EDIT} → {SEARCH}. Then input the variable No. with the Numeric keys and press [ENTER]. 
4	Move the cursor to the data of the variable.	
5	Press [SELECT].	The characters can be directly typed.
6	Input the desired characters.	For information on character input operation, refer to "1.2.6 Character Input."
7	Press [ENTER].	<p>The input characters are set to the variable on the cursor position.</p> 

■ Registering Variable Name

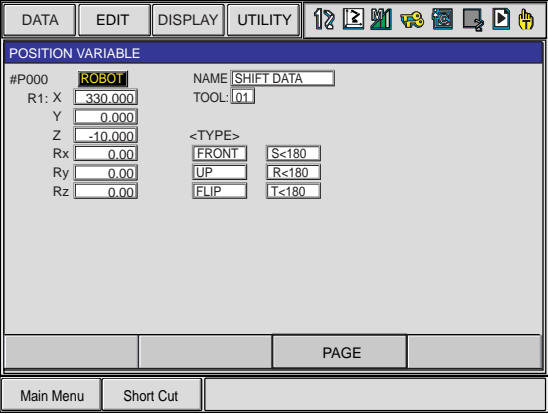
	Operation	Explanation
1	Select {VARIABLE} under the main menu.	
2	Select desired variable.	Select any variable type from among byte type, integer type, double precision integer type, real type, robot position type, base position type, and station position type.
3	Move the cursor to desired variable number.	<p>If desired variable number is not displayed, move the cursor by either of following operations.</p> <ul style="list-style-type: none"> • Select the variable number, input desired variable number and press [ENTER] The cursor moves to the variable number to be input. • Move the cursor to the menu area and select {EDIT}→{SEARCH}. Input desired variable number and press [ENTER]. The cursor moves to the variable number to be input.
4	Select "NAME."	<p>The input buffer line appears.</p> <div style="border: 1px solid black; padding: 5px; margin: 10px 0;">  Refer to " 1.2.6 Character Input " for the character input operation. </div>
5	Input name.	
6	Press [ENTER].	<p>The variable name is registered.</p> 

■ Displaying Position Variables

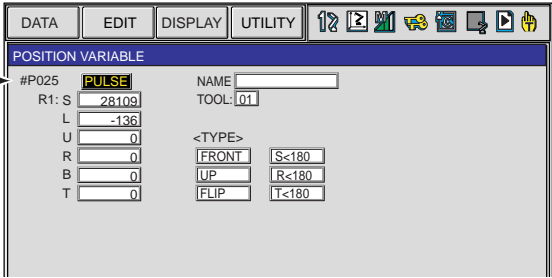
	Operation	Explanation
1	Select {VARIABLE} under the main menu.	
2	Select desired position variable type.	<p>The POSITION VARIABLE window of desired type among robot type, base type, and station type appears.</p> 
3	<p>Press the page key  or [SHIFT] + page key .</p>	<p>Select the desired number by pressing the page key  .</p> <p>If [SHIFT] is pressed simultaneously, the window returns to previous page.</p> <p>When the desired variable number is not displayed, move the cursor with either of the following operations.</p> <ul style="list-style-type: none"> • Press [DIRECT PAGE]. Then input the variable No. using the Numeric keys and press [ENTER]. • Move the cursor to the menu area and select {EDIT} → {SEARCH}. Then input the variable No. with the Numeric keys and press [ENTER]. 

■ Setting Position Variables

The following table shows the types of position variables and setting methods.

NOTE The setting of position variables is done in the teach mode.
Turn the servo power ON when setting the variables with the axis keys.

Types of Position Variables and Setting Methods

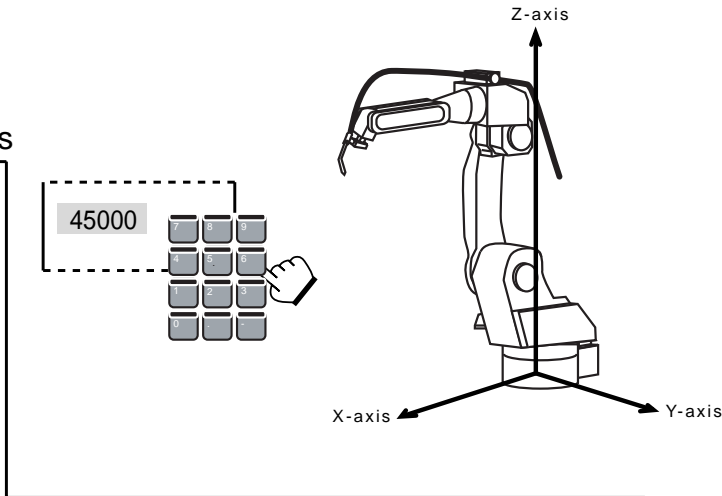
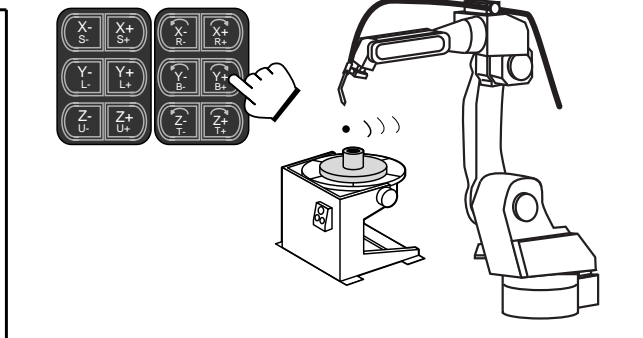
Type	Pxxx (Robot)		BPxxx (Base)		EXxxx (Station)
	Pulse Type	XYZ Type	Pulse Type	XYZ Type	Pulse Type
Setting Method	Select coordinates from base, robot, user, tool.				
	Using the numeric keys 				
Using the axis keys 					

■ Setting Position Variables Using the Numeric Keys

Pulse Type

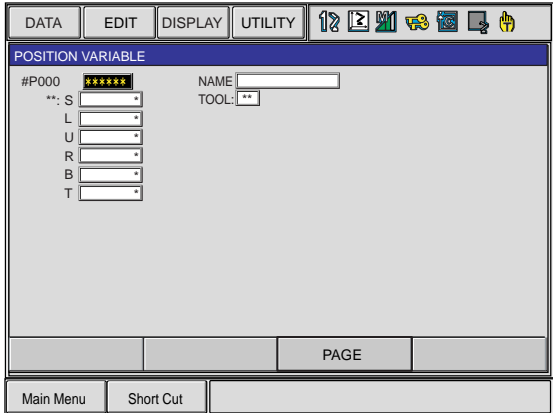
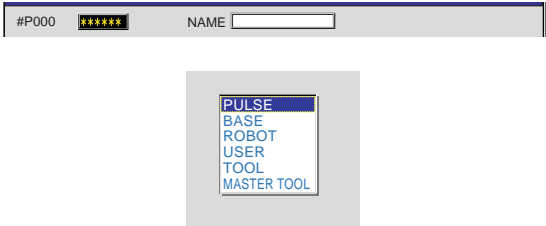
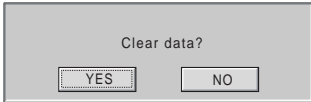
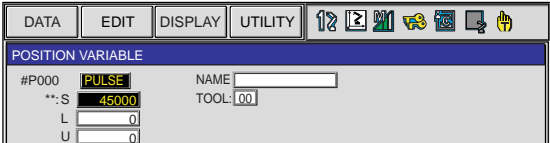
	Operation	Explanation
1	Select {VARIABLE} under the main menu.	
2	Select desired position variable type.	<p>The desired variable window appears (robot, base, or station). (The POSITION VARIABLE window is used for this example.)</p> 
3	Select the variable data type.	<p>The selection dialog box appears.</p>  <p>If the position variable was set before, confirmation dialog box appears for data clear. If “YES” is selected, the data is cleared.</p> 
4	Select {PULSE}.	
5	Move the cursor to desired data to be input and press [SELECT].	
6	Input the value.	
7	Press [ENTER].	<p>The value is set in the cursor position.</p> 

XYZ Type

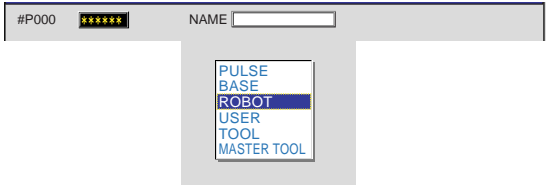
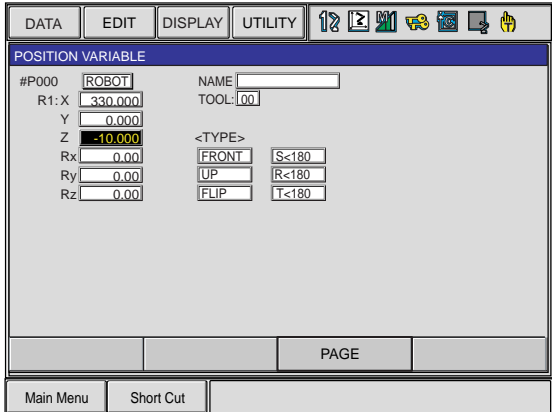
	Operation	Explanation
1	Select {VARIABLE} under the main menu.	
2	Select desired position variable type.	
3	Select the variable data type.	The selection dialog box appears. 
4	Select desired coordinates except PULSE.	
5	Move the cursor to desired data to be input and press [SELECT].	
6	Input the value.	
7	Press [ENTER].	The value is set in the cursor position. 

Setting of “<TYPE>”
Each time [SELECT] is pressed when the cursor is on the setting data in the input buffer line, the settings alternate.

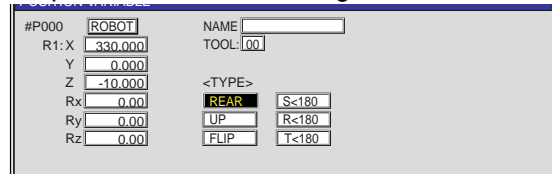

About “<TYPE>”

- It is not necessary to set a type if the position variable is to be used for parallel shift operations.
- When the position variable is used with a move instruction such as “MOVJ P001,” it is necessary to set a type. For details on types, refer to " Manipulator Types " on the page 3-76.

Current Position Window (XYZ) shows the current setting of a type.

■ Setting Position Variables Using the Axis Keys

Pulse Type

	Operation	Explanation
1	Select {VARIABLE} under the main menu.	
2	Select desired position variable type.	The desired variable window appears (robot, base, or station).
3	Press [SHIFT] + [ROBOT].	When you need an external axis position, press [SHIFT]+[EX.AXIS]. When there are two or more robot, base, or a station, specify the axis with following operation. <ul style="list-style-type: none"> • Robot Each time [SHIFT] + [ROBOT] is pressed, the axis displayed on the status line changes: R1 → R2 → R3 → R4. • Base or Station Each time [SHIFT]+[EX.AXIS] is pressed, the axis displayed on the status line changes: B1 → B2 → B3 → B4 → S1 → S2 → S3 → ... → S12
4	Move the manipulator with the axis keys.	Move the manipulator or the external axis to the desired position to be set to position variable.
5	Press [MODIFY].	
6	Press [ENTER].	

XYZ Type

	Operation	Explanation
1	Select {VARIABLE} under the main menu.	
2	Select desired position variable type.	When there are two or more robot, base, or a station, specify the axis with following operation. <ul style="list-style-type: none"> • Robot Each time [SHIFT] + [ROBOT] is pressed, the axis displayed on the status line changes: R1 → R2 → R3 → R4. • Base or Station Each time [SHIFT]+[EX.AXIS] is pressed, the axis displayed on the status line changes: B1 → B2 → B3 → B4 → S1 → S2 → S3 → ... → S12
3	Move the manipulator with the axis keys.	Move the manipulator or the external axis to the desired position to be set to position variable.
4	Press [MODIFY].	
5	Press [ENTER].	

■ Deleting Data Set of Position Variables

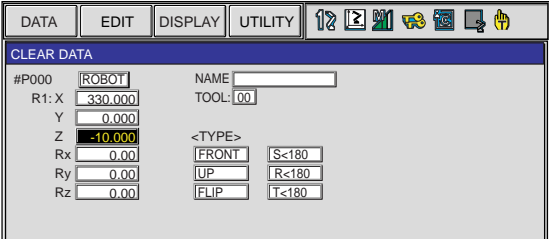
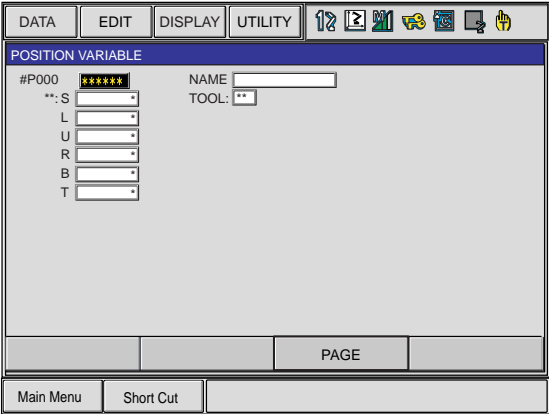
	Operation	Explanation
1	Select {VARIABLE} under the main menu.	
2	Select desired position variable type.	
3	Select {DATA} under the menu.	<p>The pull-down menu appears.</p> 
4	Select {CLEAR DATA}.	<p>The position variable data on the displayed page are deleted.</p> 

■ Checking Positions by Position Variables

	Operation	Explanation
1	Select {VARIABLE} under the main menu.	
2	Select desired position variable type.	<p>When there are two or more robot, base, or a station, specify the axis with following operation.</p> <ul style="list-style-type: none"> • Robot Each time [SHIFT] + [ROBOT] is pressed, the axis displayed on the status line changes: R1 → R2 → R3 → R4. • Base or Station Each time [SHIFT]+[EX.AXIS] is pressed, the axis displayed on the status line changes: B1 → B2 → B3 → B4 → S1 → S2 → S3 → ... → S12
3	Press [FWD].	<p>Selected axis moves to the position specified by the variable.</p> <div style="border: 1px solid black; padding: 5px; margin-top: 10px;"> <p>NOTE The selected axis (manipulator, base, or station) moves directly to the set variable position. Before pressing [FWD], check that the surrounding area is safe.</p> </div>

■ Manipulator Types

When robot axis position data is described in the XYZ format, a number of solutions are obtained from the manipulator's structure when moving it to the described position. In order to select one appropriate solution, it is necessary to specify the manipulator type. This manipulator type is called "Type." There are up to six types in NX100 system. These types also vary according to the manipulator models.

- Flip/No Flip: R-axis Position
- R-axis Angle
- T-axis Angle
- Front/Back: Relationship Between the S-axis and TCP
- Upper Arm/Lower Arm: Type Comprised of the L- and U-axes
- S-axis Angle

These six types are described in the following:

• Flip/No Flip

This shows the R-axis position.

When the R-axis is in the position at A as shown in the following diagram, it is known as "Flip;" when it is in the B position, it is called "No Flip." However, in a manipulator in which the R-axis can move more than $\pm 180^\circ$ even in position A, it is necessary to specify whether the R-axis is from -90° to 90° , or from 270° to 360° , or from -360° to -270° . The same is true for the B position. This is set at the following "R-axis Angle."

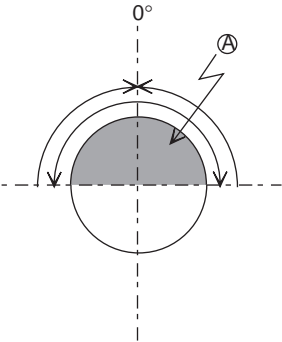
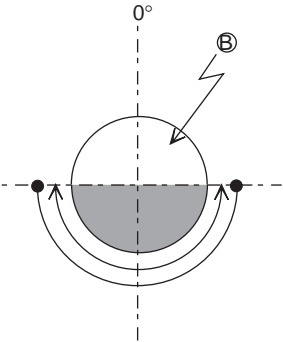
Flip	No Flip
 <p data-bbox="352 1621 767 1682"> $-90 < \theta R \leq 90$ $270 < \theta R \leq 360, -360 < \theta R \leq -270$ </p>	 <p data-bbox="1011 1621 1208 1682"> $90 < \theta R \leq 270$ $-270 < \theta R \leq -90$ </p>



θR is the angle when the R-axis home position is 0° .

• R-axis Angle

This specifies whether the R-axis angle is less than $\pm 180^\circ$ or greater than $\pm 180^\circ$.

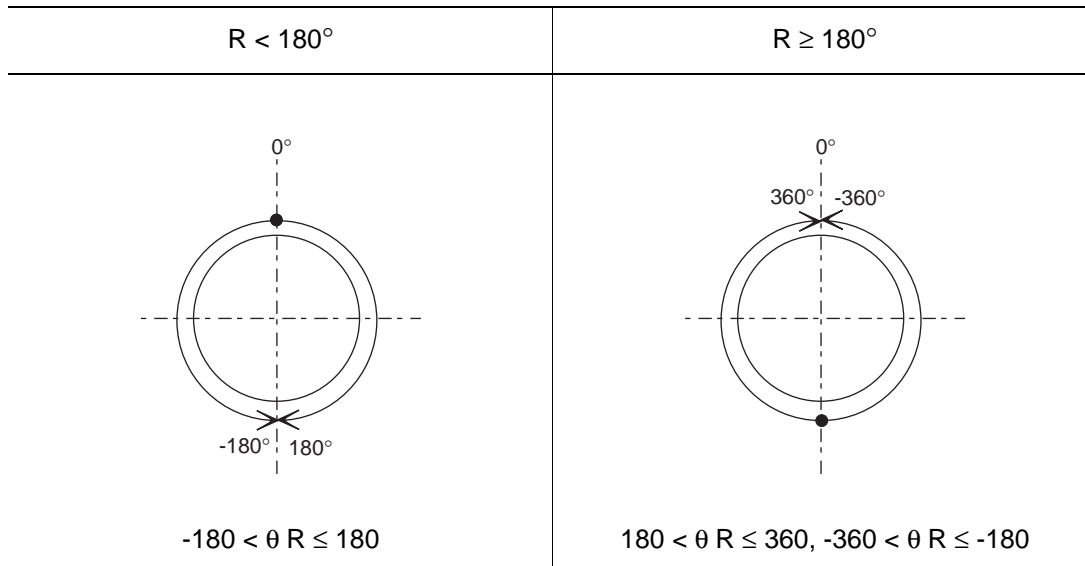

NOTE θR is the angle when the R-axis home position is 0° .

• T-axis Angle

This specifies positions of the R-, B-, and T-axis.

For manipulators with wrist axes (three axes), this specifies whether the T-axis angle is less than $\pm 180^\circ$ or greater than $\pm 180^\circ$.

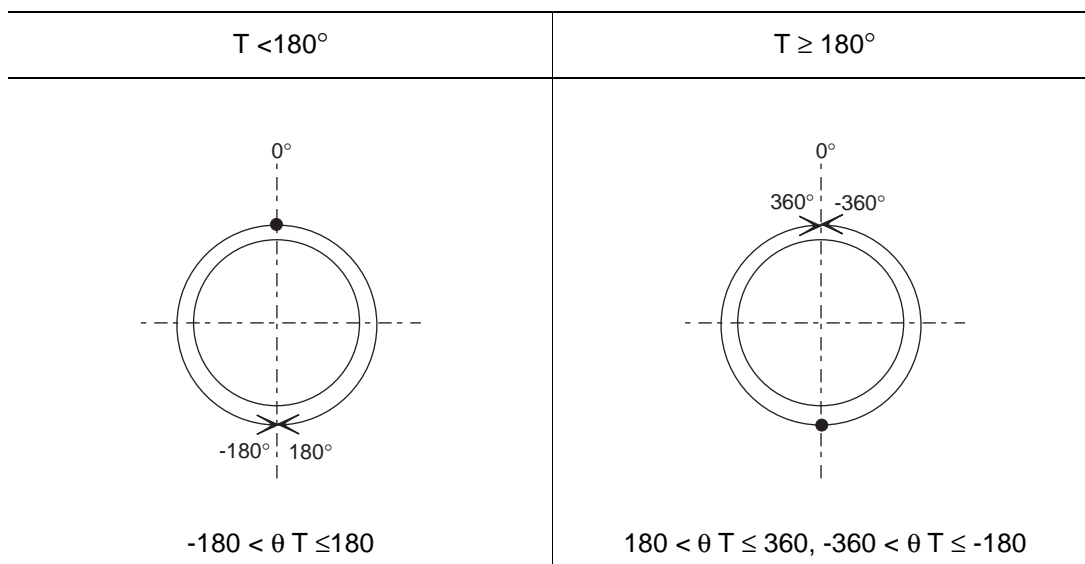

NOTE θT is the angle when the T-axis home position is 0° .

- **Front/Back**

This specifies where in the S-axis rotation center the B-axis rotation center locates when viewing the L-axis and U-axis from the right-hand side. When viewed from the right-hand side, the right of the S-axis rotation center is called the front, and the left is called the back.

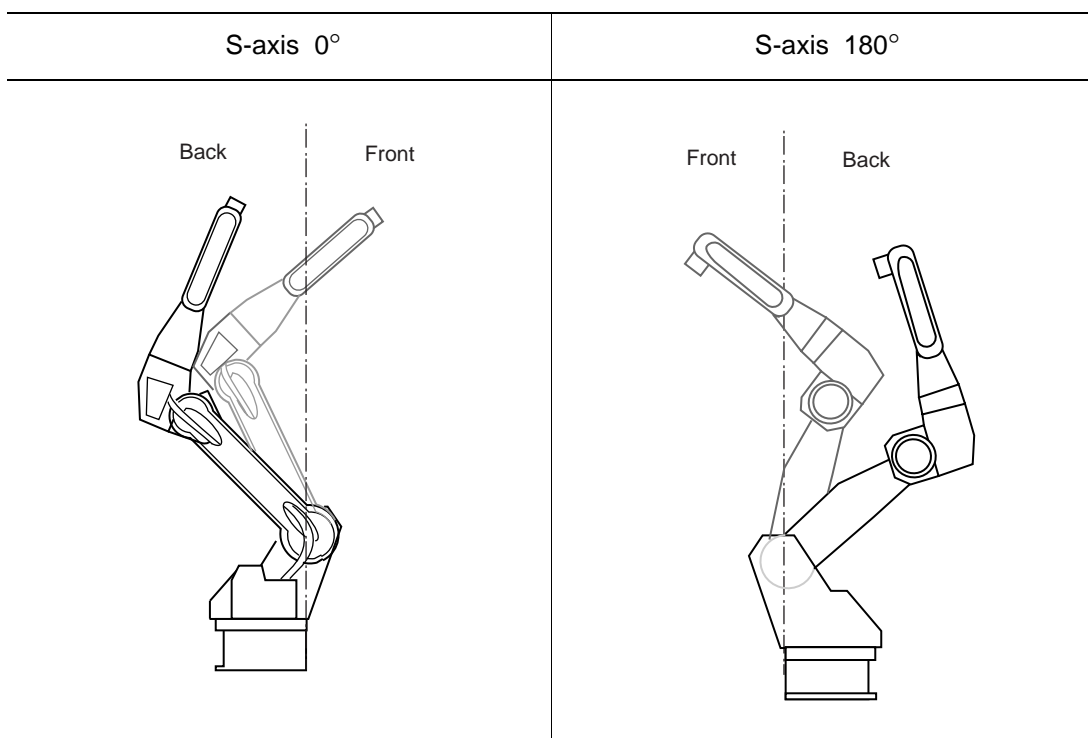
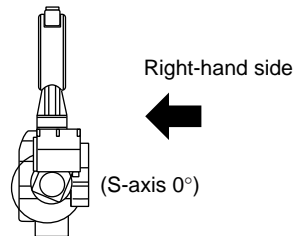

The diagram above shows the S-axis at 0° and at 180°. This is the configuration when the L-axis and the U-axis are viewed from the right-hand side.

• Upper Arm/Lower Arm

This specifies a type comprised of L-axis and U-axis when the L-axis and U-axis are viewed from the right-hand side.

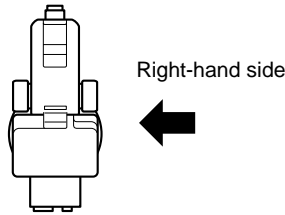

Upper Arm	Lower Arm

• S-axis Angle

This designation is required for the manipulators which have working envelopes greater than $\pm 180^\circ$.

This specifies whether the S-axis angle is less than $\pm 180^\circ$ or greater than $\pm 180^\circ$.

$S < 180^\circ$	$S \geq 180^\circ$
<p style="text-align: center;">$-180^\circ < \theta S \leq 180^\circ$</p>	<p style="text-align: center;">$180^\circ < \theta S \leq 360^\circ$ $-360^\circ < \theta S \leq -180^\circ$</p>



θS is the angle when the S-axis home position is 0° .

3.9.5 Editing Local Variables

User variables and local variables can be used in the storage of counters, calculations, and input signals. The data format is the same as that of user variables. As shown in the following table, the letter L is affixed to the variable number to indicate a local variable.

Local Variables

Data Format		Variable No.	Functions
Byte Type		LB000 to LB□□□	Range of storable values is from 0 to 255. Can store I/O status. Can perform logical operations (AND, OR, etc.).
Integer Type		LI000 to LI□□□	Range of storable values is from -32768 to 32767.
Double Precision Integer Type		LD000 to LD□□□	Range of storable values is from -2147483648 to 2147483647.
Real Type		LR000 to LR□□□	Range of storable values is from -3.4E+38 to 3.4E+38 Accuracy: $1.18E-38 < x \leq 3.4E+38$
Character Type		LS000 to LS□□□	Maximum storable number of characters is 16.
Position Type	Robot Axes	LP000 to LP□□□	Can store position data in pulse form or in XYZ form. XYZ type variables can be used as target position data for move instructions, and as incremental values for parallel shift instructions.
	Base Axes	LBP000 to LBP□□□	
	Station Axes	LEX000 to LEX□□□	

Local variables differ from user variables in the following four ways:

- **Used in One Job Only**

With user variables it is possible to define and use one variable in multiple jobs, but local variables are used only in the one job in which they are defined, and cannot be read from other jobs. Accordingly, local variables do not affect other jobs, so it is possible to define a variable number (such as LB001) separately in different jobs, and use it in different ways in each of these jobs.

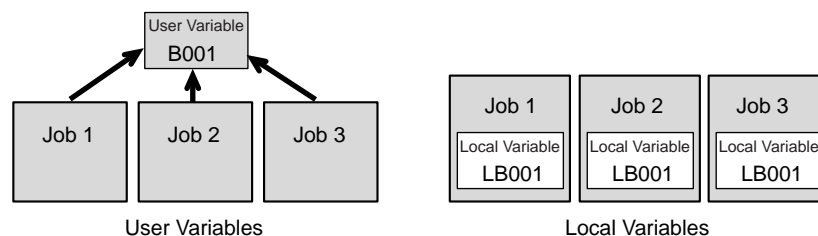

- **Able to Use Any Number of Variables**

The number is set in the JOB HEADER window. When the number is set, the area for the value is saved in memory.

• **Not Able to Display the Variable Contents**

To display the local variable contents, user variables are needed.

For example, to view the contents of local variable LP000, save it temporarily as user variable P001. Then execute the instruction SET P001 LP000, and view the POSITION VARIABLE window for P001.

• **Enabled Only During the Execution of the Defined Job**

The contents of the local variables are enabled only during the execution of the defined job.

The local variable field is assured when the defined job is called (when the job is executed by a CALL or JUMP instruction, or the job is selected by the menu). Once the job is completed by the execution of a RET, END, or JUMP instruction, the local variable data that was set is disabled. However, if a job which uses local variables itself calls a separate job, then is returned to by use of a RET instruction, the data that was present prior to the CALL instruction remains in effect and can be used.



Precautions for Variables and Units

As was the case with user variables, note that, depending on the value of the unit being used, the value of the variable and the value of the actual speed or time an occasion might not match. Refer to "3.9.4 User Variables."

■ **Setting the Number of Local Variables**

How many local variables are to be used in a job is set in the JOB HEADER window. When setting the number of variables, the memory area needed for those variables is saved.

NOTE Only when expanding the "INSTRUCTION LEVEL," it is possible to use local variables. Refer to "8.12 Instruction Level Setting" of "NX100 INSTRUCTIONS" (RE-CTO-A211) for details on setting the language level.

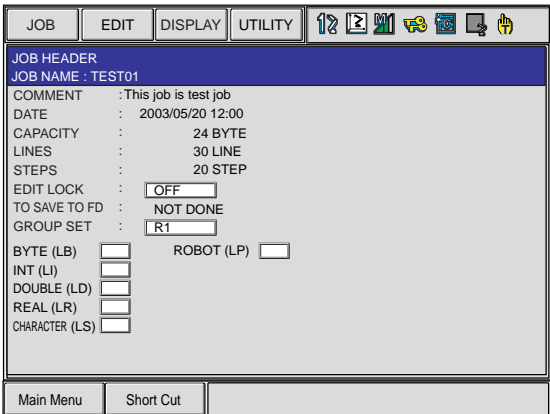
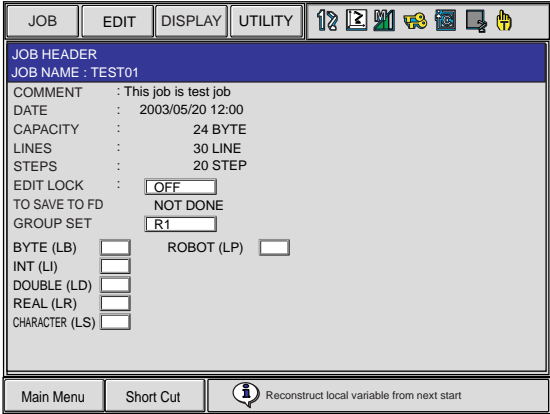
	Operation	Explanation
1	Select {JOB} under the main menu.	
2	Select {JOB}.	
3	Select {DISPLAY} under the menu.	
4	Select {JOB HEADER}.	<p>The JOB HEADER window appears. Scroll the window using the cursor.</p> 
5	Select the number of local variables to be set.	The input buffer line appears.
6	Input the number of variables.	
7	Press [ENTER].	<p>The number of local variables are set.</p> 

3.9.6 Searching

When performing editing or confirmation, a search for the job or step can be done. The search can be done when the cursor is in either the address or instruction area on the JOB CONTENT window.

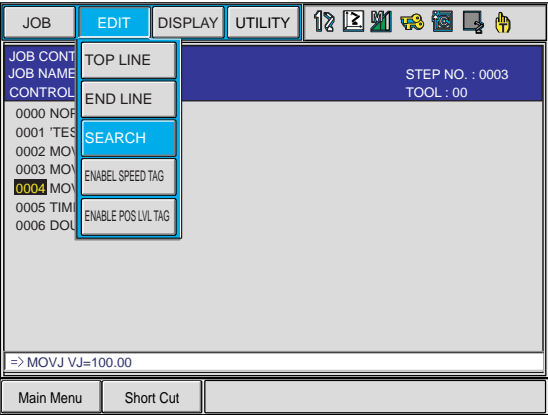
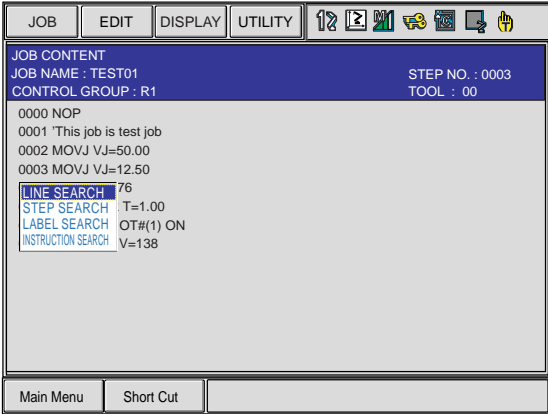
	Operation	Explanation
1	Select {JOB} under the main menu.	
2	Select {JOB}.	The JOB CONTENT window appears.
3	Select {EDIT} under the menu.	<p>The pull-down menu appears.</p> 
4	Select {SEARCH}.	<p>The selection dialog box appears.</p> 
5	Select the searching type.	

Searching is an operation by which the cursor is moved to a specific step or instruction in the edit job. A target point can be instantaneously searched out without using the cursor.

■ Line Search

This function moves the cursor to the desired line number.

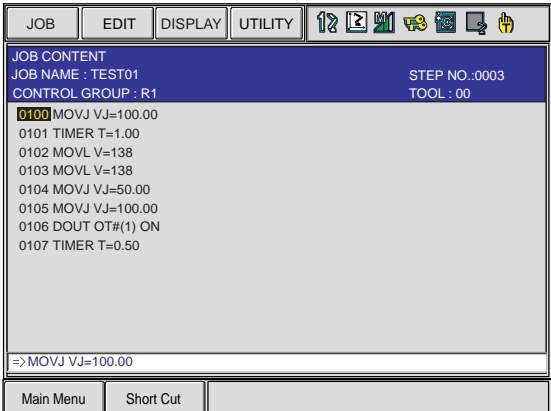
	Operation	Explanation
1	Select {EDIT}, {SEARCH} and "LINE SEARCH."	The input buffer line appears.
2	Input desired line number.	
3	Press [ENTER].	The cursor is moved to the line number and the window appears. 

■ Step Search

This function moves the cursor to the desired step number (move instruction).

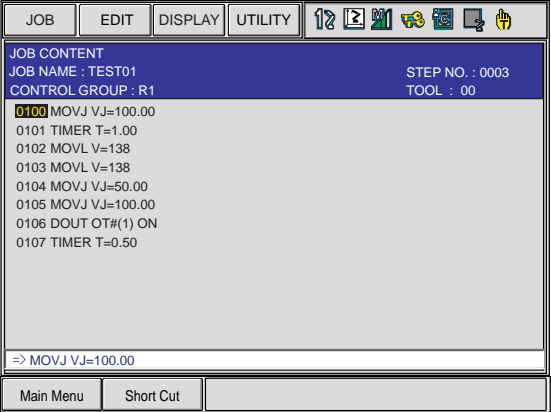
	Operation	Explanation
1	Select "STEP SEARCH."	The input buffer line appears.
2	Input desired step number.	
3	Press [ENTER].	The cursor is moved to the input step and the window appears. 

■ Label Search

This function searches for the desired label and the instruction using that label.

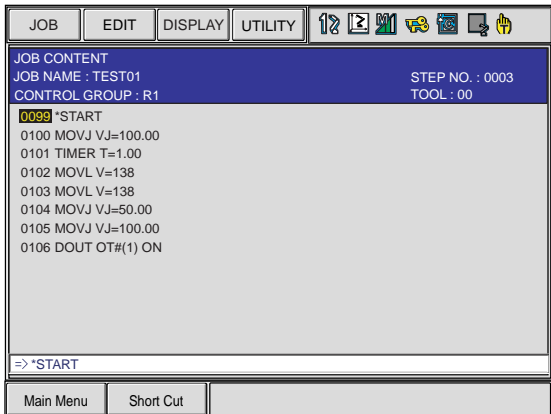
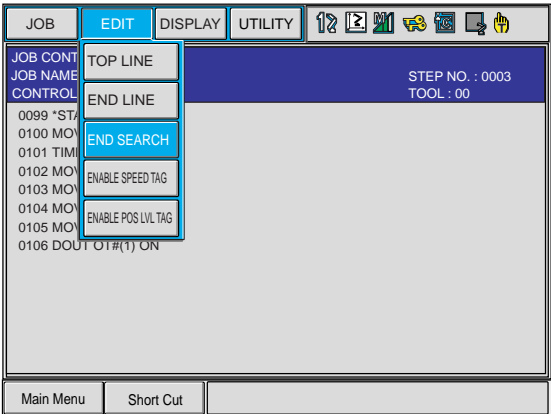
	Operation	Explanation
1	Select {EDIT}, {SEARCH} and "LABEL SEARCH."	The input buffer line appears.
2	Input desired label name.	<p>For information on character input operation, refer to "1.2.6 Character Input."</p> <p>At this time, search can be conducted by entering any one character of the label. For example, to search for the "START" label, enter only "S," and the search can be done.</p>
3	Press [ENTER].	<p>The label is searched out and the cursor is on its line number.</p>  <p>The screenshot shows a menu with 'JOB', 'EDIT', 'DISPLAY', and 'UTILITY'. Below the menu, 'JOB CONTENT' is displayed with 'JOB NAME : TEST01', 'CONTROL GROUP : R1', 'STEP NO. : 0003', and 'TOOL : 00'. A list of instructions follows, with '0099 *START' highlighted. Below the list, '=> *START' is shown in the input buffer. At the bottom, there are 'Main Menu' and 'Short Cut' buttons.</p>
4	Use the cursor to continue searching.	<p>It is possible to continue searching by pressing the cursor key. To end searching, select {EDIT} → {END SEARCH} on the menu and press [SELECT].</p>  <p>The screenshot shows the same interface as above, but with a search menu open over the instruction list. The menu options are 'TOP LINE', 'END LINE', 'END SEARCH', 'ENABLE SPEED TAG', and 'ENABLE POS LVL TAG'. The 'END SEARCH' option is highlighted. The rest of the interface remains the same.</p>

■ Instruction Search

This function moves the cursor to a desired instruction.

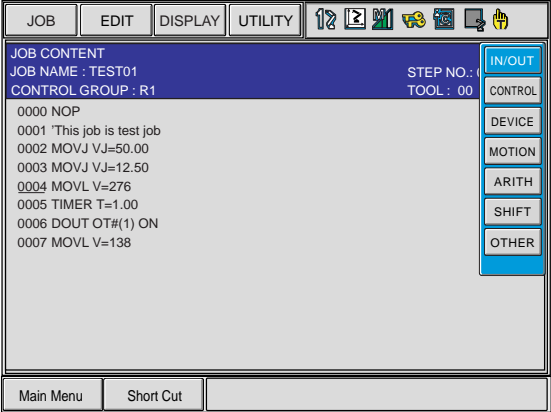
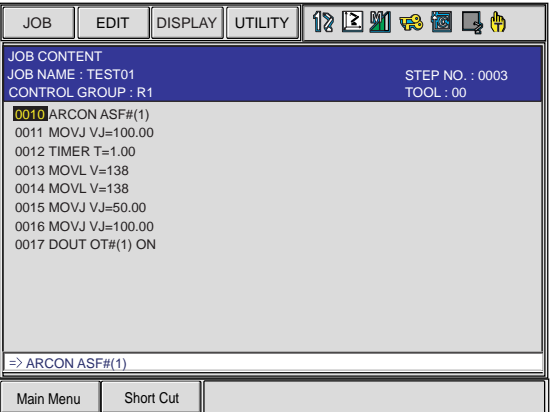
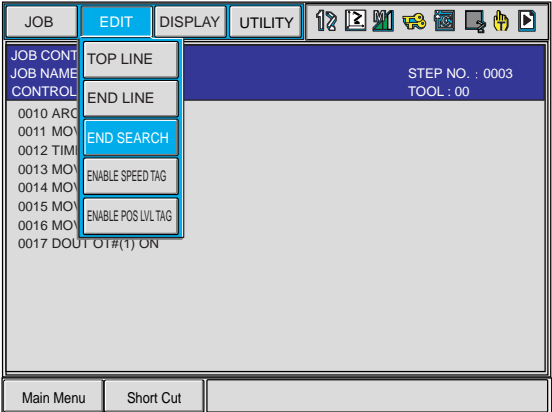
	Operation	Explanation
1	Select {EDIT}, {SEARCH} and "INSTRUCTION SEARCH."	<p>The INFORM command list appears.</p> 
2	Select desired instruction group.	
3	Select desired instruction.	<p>The instruction is searched out and the cursor is on its line number.</p> 
4	Use the cursor to continue searching.	<p>It is possible to continue searching by pressing the cursor key. To end searching, select {EDIT} → {END SEARCH} on the menu and press [SELECT] or press [CANCEL].</p> 

■ Tag Search

This function moves the cursor to the desired tag.

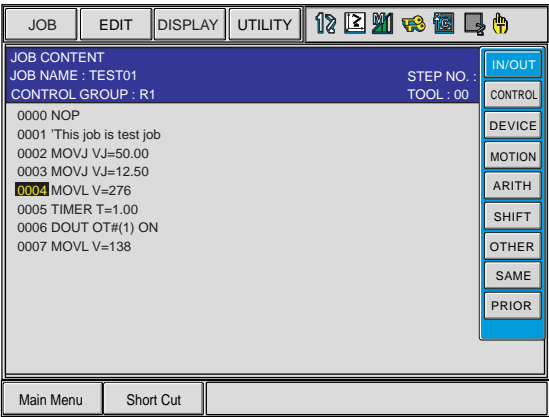
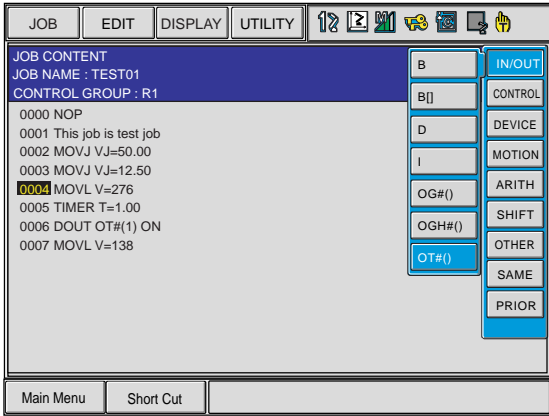
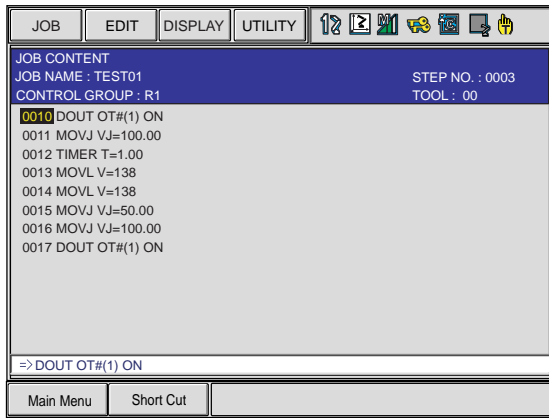
	Operation	Explanation
1	Select {EDIT}, {SEARCH} and "TAG SEARCH."	<p>The instruction list dialog box appears.</p> 
2	Select desired instruction group.	
3	Select desired instruction for which the tag is to be searched.	<p>The tag list dialog box for selected instruction appears.</p> 
4	Select the desired tag.	<p>The cursor is moved to the selected tag and the window appears.</p> 

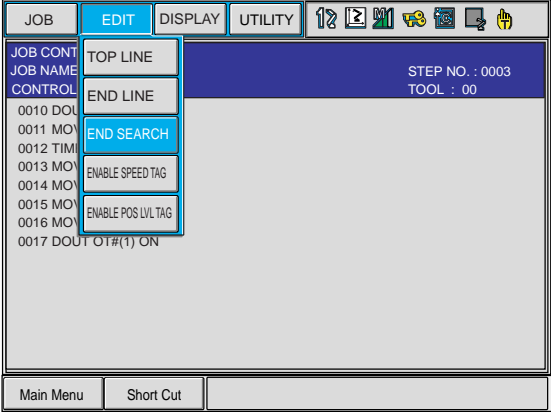
	Operation	Explanation
5	Use the cursor to continue searching.	<p>It is possible to continue searching by pressing the cursor key. To end searching, select {EDIT} → {END SEARCH} on the menu and press [SELECT] or press [CANCEL].</p>  <p>The screenshot shows a CNC control interface. At the top, there are menu tabs: 'JOB', 'EDIT', 'DISPLAY', and 'UTILITY'. Below these are several icons. The main display area is divided into a top section with 'JOB CONT', 'JOB NAME', and 'CONTROL' labels, and a bottom section with 'STEP NO.: 0003' and 'TOOL: 00'. A vertical menu is open over the 'CONTROL' section, listing options: 'TOP LINE', 'END LINE', 'END SEARCH', 'ENABLE SPEED TAG', and 'ENABLE POS LVL TAG'. The 'END SEARCH' option is highlighted in blue. At the bottom of the screen, there are 'Main Menu' and 'Short Cut' buttons.</p>

4 Playback

4.1 Preparation for Playback

4.1.1 Selecting a Job

Playback is the act of executing a taught job. Before playback operation, first call the job to be executed.

■ Calling a Job

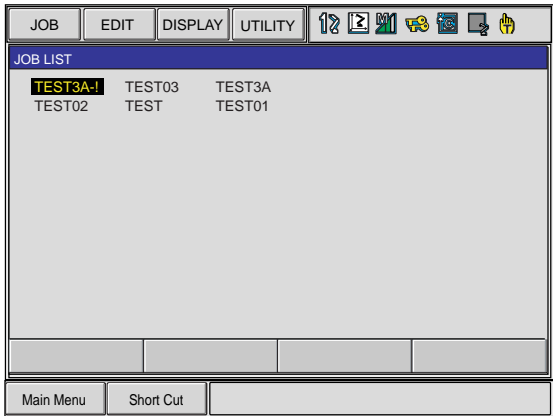
	Operation	Explanation
1	Select {JOB} under the main menu.	
2	Select {SELECT JOB}.	The JOB LIST window appears. 
3	Select the desired job.	

■ Registering the Master Job

If a particular job is played back frequently, it is convenient to register that job as a master job (master registration). A job registered as the master job can be called more easily than the method described on the preceding page.



Only one job can be registered as the master job. Registering a master job automatically releases the previously registered master job.

Be sure to register a master job in the teach mode.

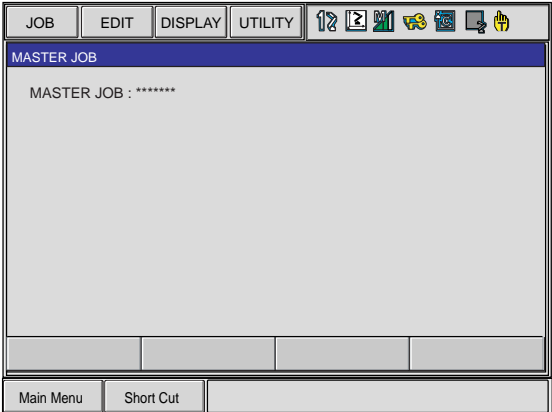
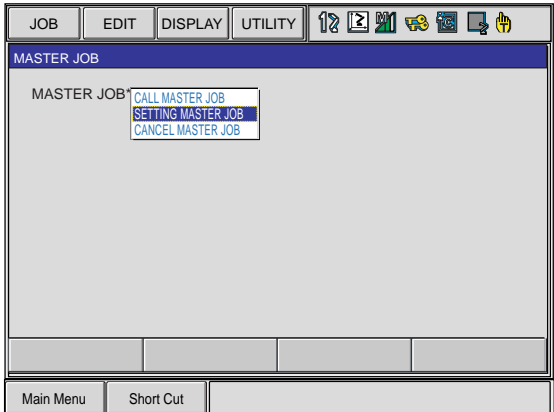
	Operation	Explanation
1	Select {JOB} under the main menu.	
2	Select {MASTER JOB}.	<p>The MASTER JOB window appears.</p> 
3	Press [SELECT].	<p>The selection dialog box appears.</p> 

4.1 Preparation for Playback

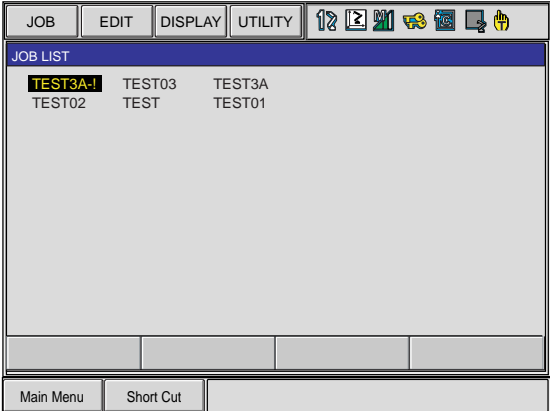
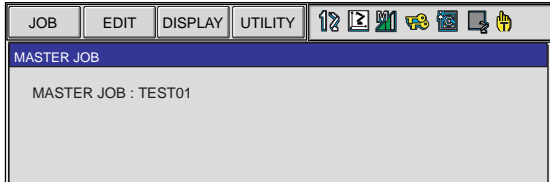
	Operation	Explanation
4	Select {CALL MASTER JOB}.	The JOB LIST window appears. 
5	Select a job to be registered as a master job.	The selected job is registered as the master job. 

■ Calling the Master Job

This operation is to call a master job. The job can be called in the JOB CONTENT window, PLAYBACK window, JOB SELECT window, or the MASTER JOB window.

Calling from the JOB CONTENT, PLAYBACK, JOB SELECT Window

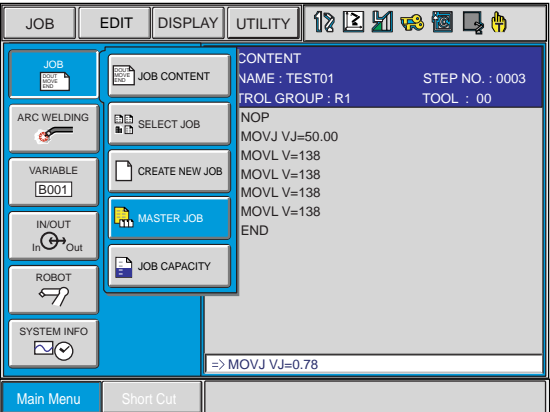
	Operation	Explanation
1	Select {JOB} under the menu.	The pull-down menu appears. 
2	Select {MASTER JOB}.	The master job is called, and the JOB CONTENT window appears.

Calling from the MASTER JOB Window

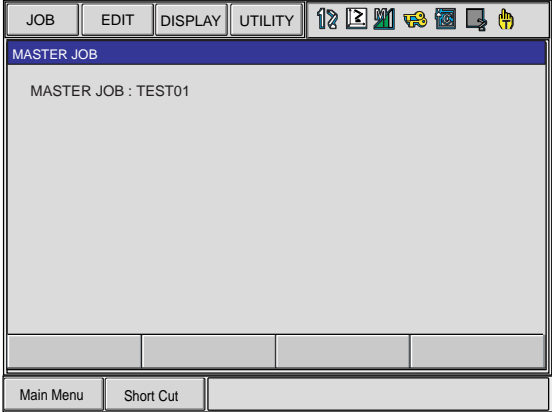
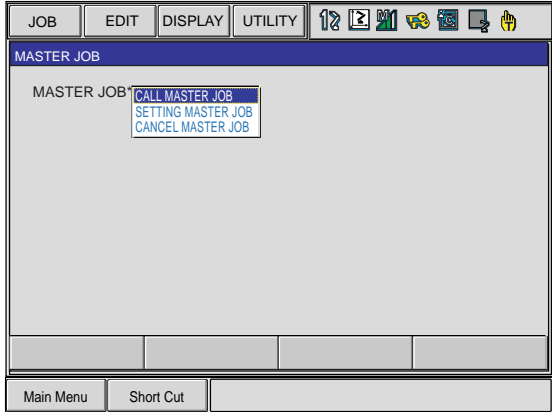
	Operation	Explanation
1	Select {JOB} under the main menu.	
2	Select {MASTER JOB}.	<p>The MASTER JOB window appears.</p> 
3	Press [SELECT].	<p>The selection dialog box appears.</p> 
4	Select {CALL MASTER JOB}.	<p>The master job is called, and the JOB CONTENT window (during the teach mode), or the PLAYBACK window (during the play mode) appears.</p>

4.1.2 The PLAYBACK Window

When the mode switch on the programming pendant is switched to “PLAY” while displaying the JOB CONTENT window, the PLAYBACK window appears.

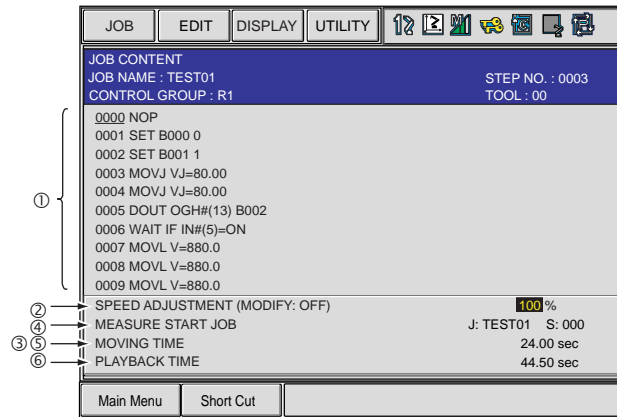

① Job Content

The cursor moves according to the playback operation. The contents are automatically scrolled as needed.

② Override Speed Settings

Displayed when override speed setting is performed.

③ Cycle Time

Displays the operating time of the manipulator. Each time the manipulator is started, the previous cycle time is reset, and a new measurement begins. The setting can be made for display or no display.

④ Start No.

First step in the measurement. Measurement starts when the start button lamp lights and the playback starts.

⑤ Motion Time

Displays the weaving time of the manipulator.

⑥ Playback Time

Displays the time from beginning to the end of the measurement. Measurement ends when the manipulator stops and the start button lamp goes off.

■ Display of Cycle Time

Follow the procedure below to set whether or not to display the cycle time on the PLAYBACK window.

	Operation	Explanation
1	Select {DISPLAY} under the menu.	
2	Select {CYCLE TIME}.	The cycle time is displayed. Doing the same operation one more time will delete the cycle time display.

■ Operation Cycle

There are three types of manipulator operation cycles:

- AUTO : Repeats a job continuously.
- 1 CYCLE : Executes a job once. If there is a called job during execution, it is performed, after which the manipulator returns to the original job.
- 1 STEP : Executes one step (instruction) at a time.

The operation cycle can be changed using the following:

	Operation	Explanation
1	Select {JOB} under the main menu, and then select {CYCLE}.	
2	Select the operation cycle to be changed.	The operation cycle is changed.

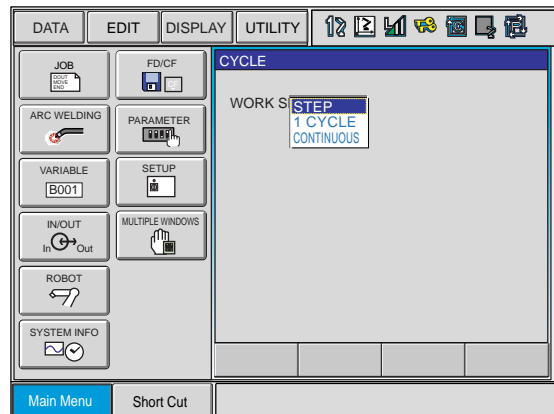

Automatic Setting for Operation Cycle

Automatic setting of the operation cycle can be changed by the following operation. This can be done in the management mode only.

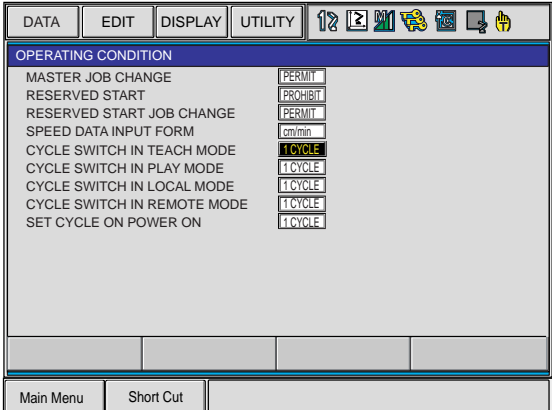
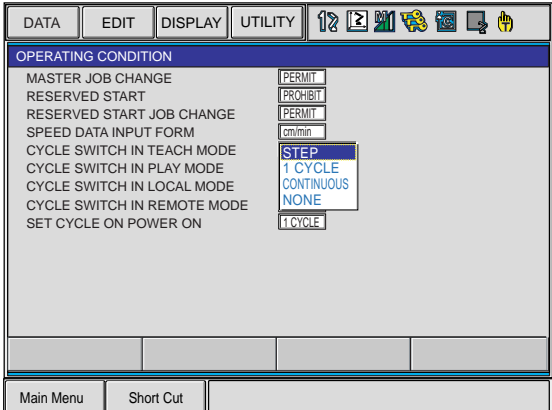
	Operation	Explanation
1	Select {SETUP} under the main menu.	
2	Select {OPERATE COND}.	<p>The OPERATING CONDITION window appears. Use the cursor to scroll the screen.</p> 
3	Select desired operation.	<p>The selection dialog box appears.</p>  <div style="border: 1px solid black; padding: 10px; margin-top: 10px;"> <p>“NONE” setting</p> <p>The operation cycle is not changed when “NONE” is set.</p> <p>For example, if the setting is “CYCLE SWITCH IN TEACH MODE = NONE,” the operation cycle after selecting the teach mode is the same as the one before.</p> </div>

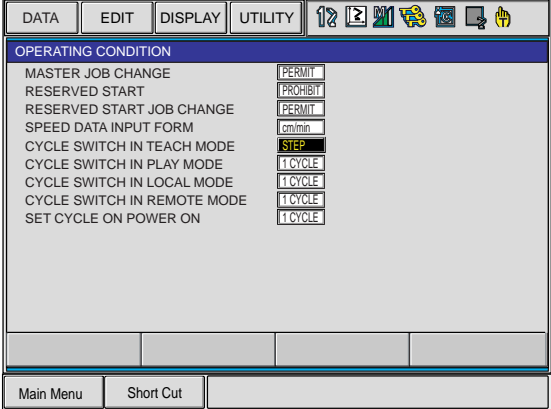
	Operation	Explanation
4	Select a cycle.	The operation cycle set automatically is changed. 

4.2 Playback

4.2.1 Playback Operation



After checking to be sure there is no one near the manipulator, start the playback operation by following the procedures below.

Playback is the operation by which the taught job is played back. Follow the procedures below to start the playback operation.

- Programming pendant (start button)
- Peripheral device (external start input)

Which is used to start playback is specified by the mode switch on the programming pendant.

Mode Switch on Programming Pendant	Job is started up by peripheral device
[PLAY]	[START] button on programming pendant
[REMOTE]	Peripheral device

For playback using the programming pendant, follow the procedures below.

■ Selecting the Start Device

	Operation	Explanation
1	Set the mode switch on the programming pendant to "PLAY."	The remote mode is disabled and the play mode is enabled so the machines are to be started up by the programming pendant.

■ Servo On

	Operation	Explanation
1	Press [Servo ON Ready].	NX100 servo power is ON and the Servo ON lamp on the programming pendant lights.

■ Start Operation

	Operation	Explanation
1	Press [START].	The start button lamp lights and the manipulator begins operation.

4.2.2 Special Playback Operations

The following special operations can be performed during playback:

- Low speed operation
- Limited speed operation
- Dry run speed operation
- Machine lock operation
- Check mode operation

Two or more special operations can be performed at the same time. If multiple operations are selected, the speed during playback is limited to the speed of the slowest of the operations.

Settings for special operations are done in the SPECIAL PLAY window.

When displaying the PLAYBACK window, move the cursor to the menu area and select {UTILITY} → {SETUP SPECIAL RUN}. The SPECIAL PLAY window appears.

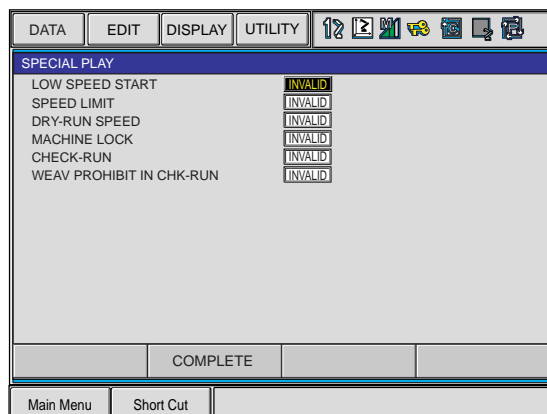

■ Low Speed Operation

The manipulator moves at low speed during the first step after starting. After the operation of this step, the manipulator stops regardless of the selection of the operation cycle and when low speed operation is canceled. Even if the manipulator is manually stopped during low speed operation, the low speed is cancelled.

After one step operation or any stop of manipulator during low speed operation, pressing [START] allows the manipulator to move at the taught speed.

	Operation	Explanation
1	Select "LOW SPEED START" on the SPECIAL PLAY window.	The setting alternates between "VALID" and "INVALID."
2	Select "COMPLETE."	The window returns to the PLAYBACK window.

■ Limited Speed Operations

The manipulator operates within the limited speed for the teach mode. Usually, the limited speed is set to 250mm/s. However, operation is performed at actual playback speeds for steps in which the set speed is under this limit.

	Operation	Explanation
1	Select "SPEED LIMIT" under the SPECIAL PLAY window.	The setting alternates between "VALID" and "INVALID."
2	Select "COMPLETE."	The window returns to the PLAYBACK window.

■ Dry-run Speed Operations

The dry-run speed is a constant speed that is independent of the teaching speeds. The manipulator executes all the steps at a constant speed, which is convenient for quick check of a job consisting of slow operations. The dry-run speed is 10% of maximum speed.

NOTE Be careful of steps programmed at lower speeds than the dry-run speed, because they are executed at greater speeds than programmed.

	Operation	Explanation
1	Select the "DRY-RUN SPEED" under the SPECIAL PLAY window.	The setting alternates between "VALID" and "INVALID."
2	Select "COMPLETE."	The window returns to the PLAYBACK window.

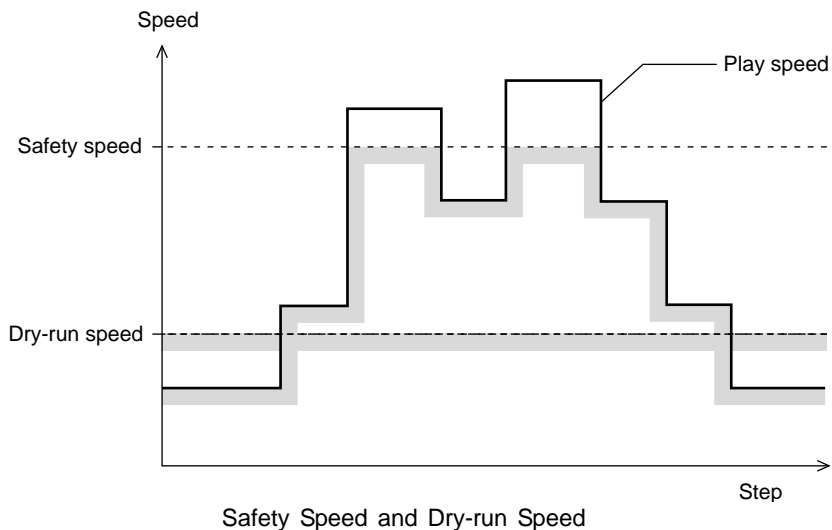

■ Machine Lock Operation

A job is played back without moving the manipulator to check the status of input and output.

	Operation	Explanation
1	Select "MACHINE LOCK" under the SPECIAL PLAY window.	The setting alternates between "VALID" and "INVALID."
2	Select "COMPLETE."	The window returns to the PLAYBACK window.

■ Check Mode Operation

The machine runs without issuing work instructions, such as the ARCON instruction. It is used primarily to check the path of the program.

	Operation	Explanation
1	Select "CHECK-RUN" under the SPECIAL PLAY window.	The setting alternates between "VALID" and "INVALID."
2	Select "COMPLETE."	The window returns to the PLAYBACK window.

■ Weaving Prohibit Setting during Check Mode Operation

The weaving operation is not executed in the weaving section of the job.

	Operation	Explanation
1	Select "WEAV PROHIBIT IN CHK-RUN" under the SPECIAL PLAY window.	The setting alternates between "VALID" and "INVALID."
2	Select "COMPLETE."	The window returns to the PLAYBACK window.

■ Cancel All Special Operations

All special operations are disabled by the following operation

	Operation	Explanation
1	Select {EDIT} from the menu.	
2	Select "CANCEL ALL SELECT."	The message "All special functions canceled" appears.



Special operations are also automatically cancelled if the main power is shut OFF.

4.3 Stop and Restart

The manipulator stops in the following conditions:

- Hold
- Emergency stop
- Stop by alarm
- Others
- During each application

4.3.1 Hold

Hold operation causes the manipulator to stop all motion.



[HOLD] lamp lights while it is held down. At the same time, [START] lamp goes OFF.

■ Using the Programming Pendant

Hold

	Operation	Explanation
1	Press [HOLD] on the programming pendant.	The manipulator stops. The [HOLD] lamp lights while the [HOLD] button is held down.

Release

	Operation	Explanation
1	Press [START] on the programming pendant.	The manipulator restarts its operation from the position where it was stopped.

■ Using an External Input Signal (System Input)

Hold

	Operation	Explanation
1	Turn ON the hold signal from an external input (system input).	The manipulator stops momentarily.  External holding The output signal "HOLD" turns ON. The programming pendant [HOLD] lamp lights.

Release





	Operation	Explanation
1	Turn off the hold signal from an external input (system input).	Hold is released. To continue the operation, press [START] or turn ON the external input signal (system input). The manipulator restarts its operation, beginning from the position where it was stopped.

4.3.2 Emergency Stop





At an emergency stop, the servo power supply that drives the manipulator is turned OFF and the manipulator stops immediately. An emergency stop can be performed by using either of the following:

- Programming pendant
- External input signal (system input)

Emergency Stop

	Operation	Explanation
1	Press the emergency stop button  .	<p>The servo power turns OFF and the manipulator stops immediately.</p> <p style="text-align: center;">EMERGENCY STOP</p> <p>On the front door of the NX100: </p> <p>On the programming pendant: </p> <p>Using the Emergency Stop Button on the Programming Pendant</p> <div style="border: 1px solid gray; padding: 5px; margin-bottom: 10px;">  Robot stops by P.P. emergency stop </div> <p>Using the External Input Signal (System Input)</p> <div style="border: 1px solid gray; padding: 5px;">  Robot stops by external emergency stop </div>

Release

	Operation	Explanation
1	Turn the emergency stop button  in the direction of the arrows.	<p>On the front door of the NX100: </p> <p>On the programming pendant: </p> <p>To turn ON the servo power supply again, press [SERVO ON READY] and then grip the Enable switch of the programming pendant.</p> <div style="text-align: center;">   </div>

■ Restart After Emergency Stop



CAUTION

- **Prior to restarting after an emergency stop, confirm the position for the next operation and make sure there is no interference with the workpiece or fixture.**

The application of an emergency stop during high speed operations on continuous steps can result in the manipulator stopping two or three steps prior to the step that is being displayed. There is a risk of interference with the workpiece or fixture when the manipulator is restarted under such conditions.

4.3.3 Stop by Alarm

If an alarm occurs during operation, the manipulator stops immediately and the ALARM window appears on the programming pendant indicating that the machine was stopped by an alarm.

If more than one alarm occurs simultaneously, all alarms can be viewed on the window. Scroll down the viewing area of the window when necessary.

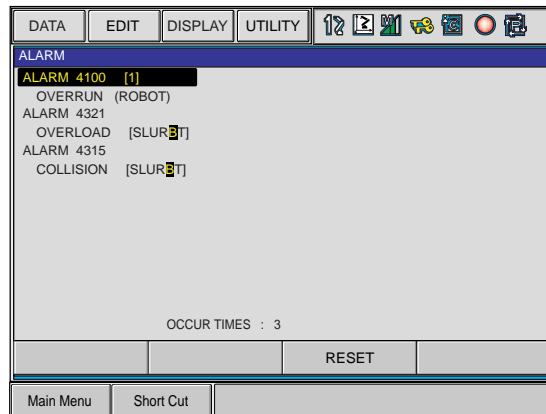

The following operations are available in the alarm status: window change, mode change, alarm reset, and emergency stop.

To display the ALARM window again when the window is changed during alarm occurrence, select {SYSTEM INFO} and then {ALARM HISTORY}.

Releasing Alarms

- Minor Alarms

	Operation	Explanation
1	Press [SELECT].	Select "RESET" under the ALARM window to release the alarm status. When using an external input signal (system input), turn ON the "ALARM RESET" setting.

- Major Alarms

	Operation	Explanation
1	Turn OFF the main power supply and remove the cause of the alarm.	If a severe alarm, such as hardware failure occurs, servo power is automatically shut off and the manipulator stops. If releasing does not work, turn OFF the main power and correct the cause of the alarm.

4.3.4 Others

■ Temporary Stop by Mode Change

When the play mode is switched to the teach mode during playback, the manipulator stops immediately.

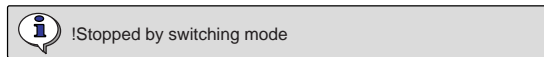

To restart the operation, return to the play mode and perform a start operation.

■ Temporary Stop by the PAUSE Instruction

When the PAUSE instruction is executed, the manipulator stops operating.

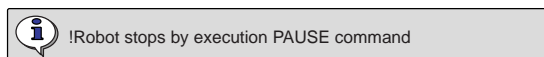

To restart the operation, perform a start operation. The manipulator restarts from the next instruction.

4.4 Modifying Play Speed

4.4.1 Speed Override

Speed modifications using the speed override have the following features:

- Speed can be modified during playback.
The job can be played back at various speeds until the play speed is properly adjusted.
- Speed can be increased or decreased by a ratio of the current play speed.
The ratio settings range from 10% to 150% in increments of 1%.



Therefore, it is convenient when, for example, all play speed settings are to be increased by 150% at the same time.

The operation flow override of play speeds is as shown in the following:

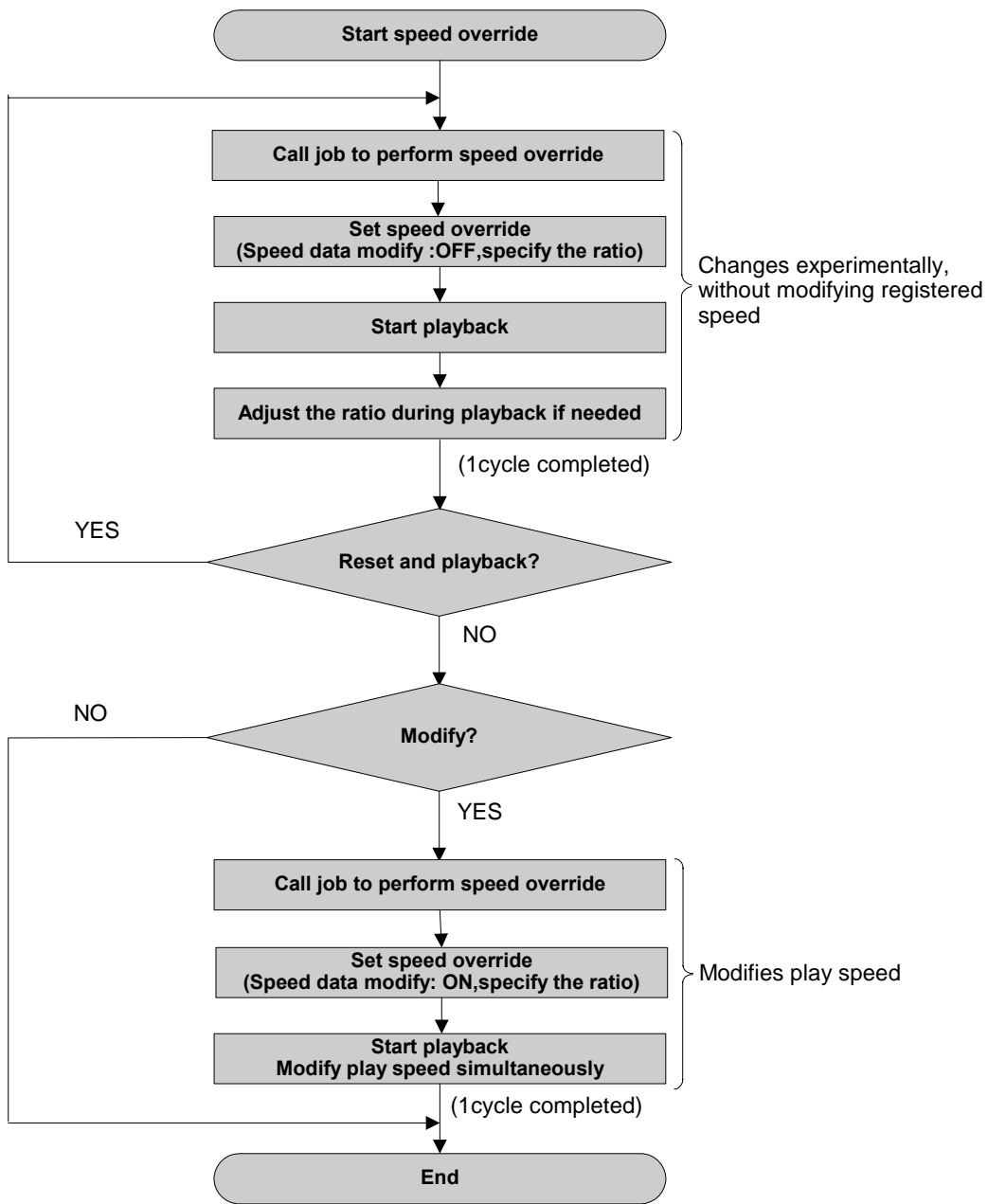
4.4 Modifying Play Speed

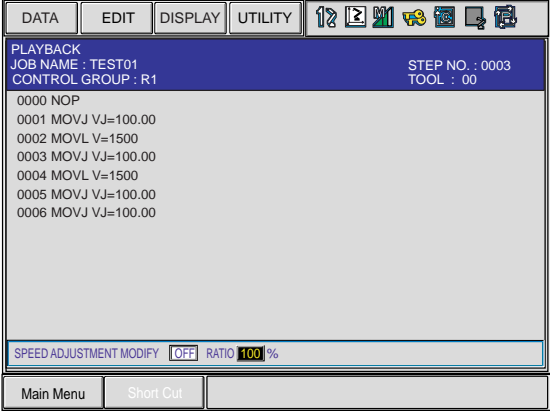
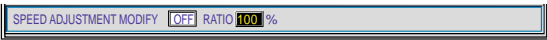

■ Setting Speed Overrides

	Operation	Explanation
1	Select {UTILITY} under the menu in the PLAYBACK window.	
2	Select {SPEED OVERRIDE}.	<p>The PLAYBACK window becomes the speed override condition.</p> 
3	Select "ON" or "OFF" under "MODIFY."	<p>Each time [SELECT] is pressed when the cursor is on the data of the item "MODIFY," "ON" and "OFF" alternate.</p> <p>Select "ON" to modify the registered play speed during playback. When "OFF" is selected, the registered play speed is not modified. To change the play speed temporarily (for example, to experiment with various speeds), select "OFF."</p> 
4	<p>Line up the cursor with the override ratio and move the cursor up and down to change the ratio.</p> <p>If you want to input the ratio number directly, move the cursor to the override ratio and press [SELECT].</p>	<p>The number input line appears. Input the override ratio using the Numeric keys.</p> 

■ Modifying Play Speed

	Operation	Explanation
1	Set speed override.	
2	Playback the manipulator.	The play speed is increased or decreased in the set ratio. When setting "MODIFY" to "ON," the step's play speed is modified when each step is reached. When one cycle is completed by the END instruction, the speed override setting is released.

NOTE

- Assuming that the manipulator moves from step 1 to step 2, the play speed of step 2 is not modified if the speed override is released before reaching step 2.
- When the play speed is changed by speed override, the maximum and minimum speed is limited by the manipulator.
- When the safety speed operation is commanded with the setting of "MODIFY: ON," the manipulator operates at safety speed. However, the play speed in memory is modified as set using speed override.
- Play speed set by the SPEED instruction is not modified.

■ Releasing Speed Override Settings

	Operation	Explanation
1	Select {UTILITY} under the menu in the PLAYBACK window.	
2	Select {SPEED OVERRIDE}.	The setting of the speed override ratio is released. If it is released, the speed ratio setting is not displayed on the PLAYBACK window.

NOTE

The speed override settings are automatically released in the following cases:

- When dry-run speed operation is set.
- When the mode is changed to any mode other than the play mode.
- When an alarm or error occurs.
- When one cycle operation is completed with the END instruction.
- When the power supply is turned OFF.

4.5 Playback with Reserved Start

4.5.1 Preparation for Reserved Start

In the reserved start function, jobs registered at different stations are played back in the reserved order using the start buttons on the stations.

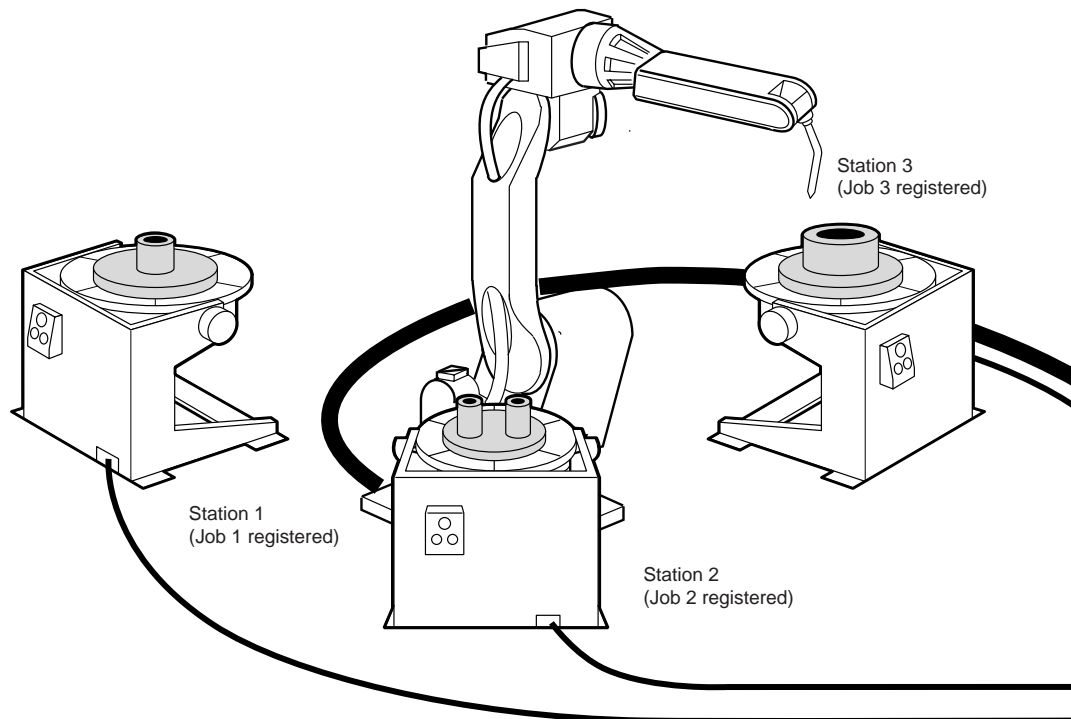

For example, in a case where three stations handle three different workpieces, as shown in the illustration above, the jobs would be registered as follows:

- Job 1 is registered to process workpiece 1 at Station 1
- Job 2 is registered to process workpiece 2 at Station 2
- Job 3 is registered to process workpiece 3 at Station 3

To play back the jobs, prepare workpiece 1 and press the start button on Station 1. The manipulator executes Job 1. Prepare workpieces 2 and 3 while Job 1 is being executed, and press the start buttons on Stations 2 and 3. Even if Job 1 is being executed at that time, jobs on different stations are reserved in the order that the start buttons were pressed, and will be executed in that order. During playback, the status of the reservation can be checked on the start reservation window.

■ Enabling Reserved Start

The start button on the station is operative when the reserved start function is enabled, and the following start operations are disabled.

- [START] on the programming pendant
- Start operation from external input signal (system input)

NOTE The OPERATING CONDITION window is shown only when the security mode is management mode

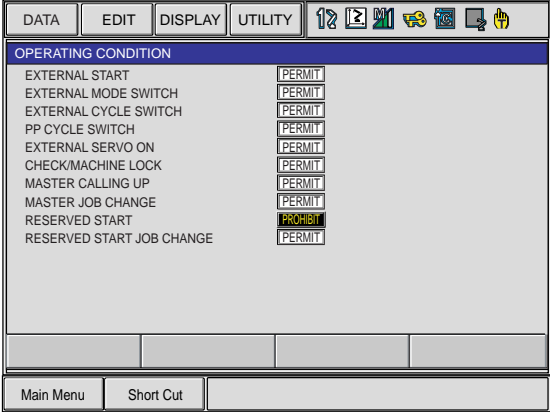
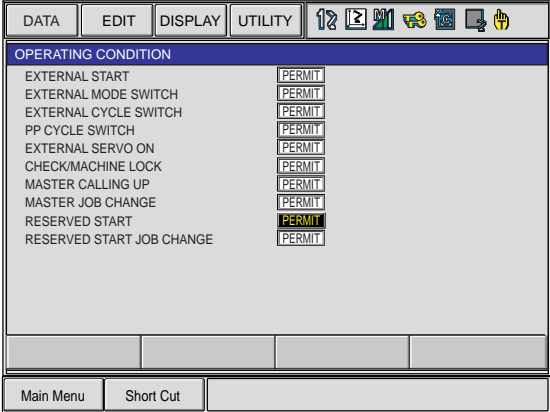
	Operation	Explanation
1	Select {SETUP} under the main menu.	
2	Select {OPERATE COND}.	<p>The OPERATING CONDITION window appears. The screen is scrolled up/down by the cursor key when it locates at the top/bottom of the items.</p> 
3	Select "RESERVED START."	<p>Each time [SELECT] is pressed, "PERMIT" and "PROHIBIT" alternate. Select "PERMIT."</p> 

NOTE When reserved start is enabled, the external start and the programming pendant start are prohibited even if setting is "PERMIT."
Regardless of the operation cycle selected, it is automatically set to 1 CYCLE.

■ Registering Reserved Start I/O Signal

Register the start I/O signal as a preparation to perform start operation from the station.



This operation can be done only when the operation mode is teach mode and the security mode is management mode.

	Operation	Explanation
1	Select {SETUP} under the main menu.	
2	Select {RES. START(CNCT)}.	The RESERVED START (CNCT) window appears. <div style="text-align: center;"> </div>
3	Select "START IN" or "START OUT" for each station.	The number can now be entered. <div style="text-align: center;"> </div>
4	Input signal number and press [ENTER].	The input/output signal number is registered. <div style="text-align: center;"> </div>

■ Registering Jobs to Stations

Register the starting job of each station.

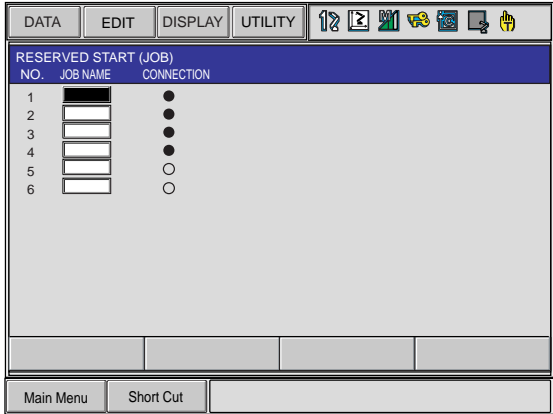
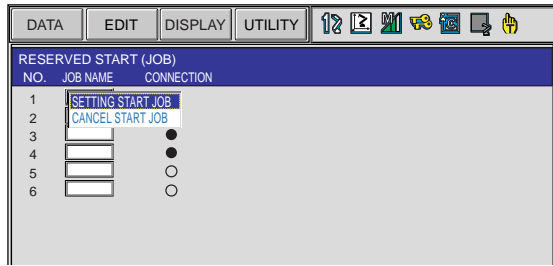
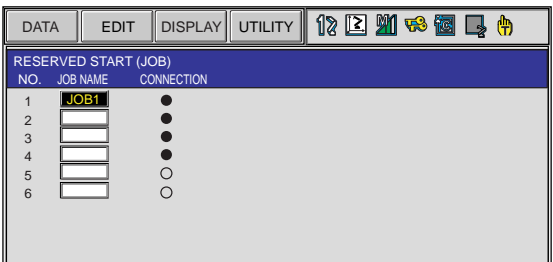

This operation can be done only when the operation mode is teach mode and the setting of “RESERVED START JOB CHANGE” is “PERMIT” in the OPERATING CONDITION window.

	Operation	Explanation
1	Select {JOB} under the main menu.	
2	Select {RES. START(JOB)}.	<p>The RESERVED START (JOB) window appears.</p> <p>● indicates that the input/output number is registered. ○ indicates that the input/output number is not registered.</p> 
3	Select job name for each station.	<p>The selection dialog box appears.</p> 
4	Select “SETTING START JOB.”	The JOB LIST window appears.
5	Select a job.	<p>The starting job is registered.</p> 

■ Deleting Registered Jobs from Stations

Delete the registered job of each station.

NOTE This operation can be done only when the operation mode is teach mode and the setting of “RESERVED START JOB CHANGE” is “PERMIT” in the operation condition display.

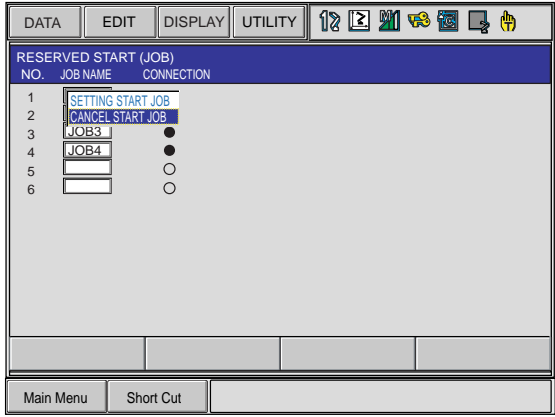
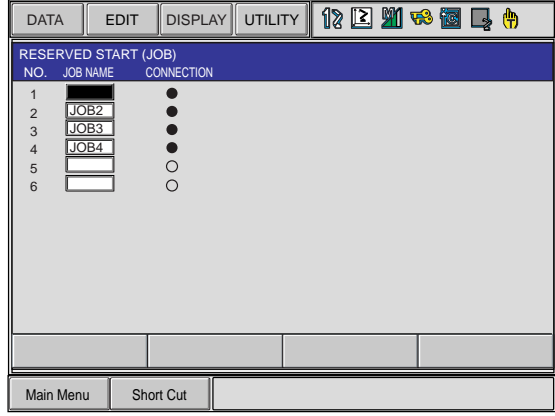
	Operation	Explanation
1	Select {JOB} under the main menu.	
2	Select {RES. START(JOB)}.	The RESERVED START (JOB) window appears.
3	Select job name for each station.	The selection dialog box appears. 
4	Select “CANCEL START JOB.”	Registered job is deleted. 

4.5.2 Playback from Reserved Start

■ Start Operation

	Operation	Explanation
1	Set the mode switch to "PLAY."	
2	Press start button on the station.	The job registered for the station starts up and the manipulator performs one cycle operation.

NOTE

- While the job is being executed, the start button lamp on the station lamps.
- If the workpiece must be prepared at the station, prepare it before pressing the start button.
- If the start button of another station is pressed during execution of a job at one station, the job on the station is reserved and prepares to start. Jobs are reserved and executed in the order that the start buttons are pressed.
- When a job is reserved, the start button lamp on the station blinks.
- No station job is reserved when it is being executed even if its start button is pressed.
- To suspend a job being executed, perform the Hold operation.



Reservations are cancelled when the start button is pressed again during the job reservation operation.

■ Checking Job Reservation Status

The job reservation status during playback can be checked.

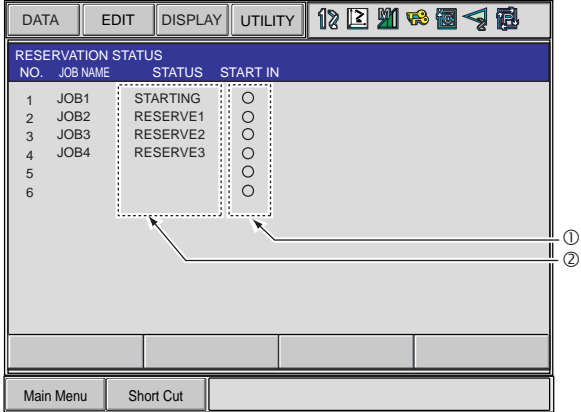
	Operation	Explanation
1	Select {JOB} under the main menu.	
2	Select {RES. STATUS}.	<p>The RESERVATION STATUS window appears.</p>  <p>① STATUS Reservation status is displayed. STARTING: Indicates the station currently working. STOP: Indicates any station where work has been temporarily stopped by a hold operation. RESERVE1,RESERVE2,...: Indicates the order in which jobs have been reserved for start.</p> <p>② START IN Input signal status is displayed. “●”: Input signal ON “○”: Input signal OFF</p>

■ Resetting Job Reservation

NOTE If “STARTING” is displayed, the job cannot be reset.

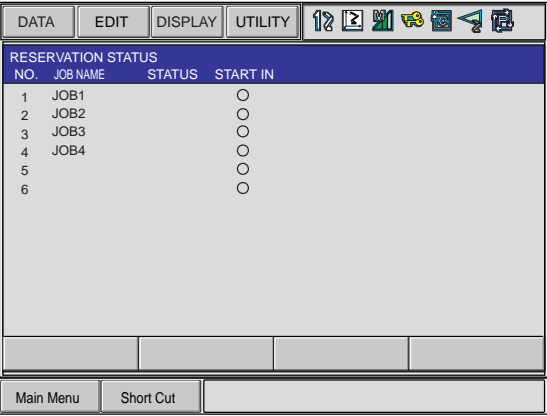
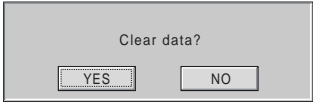
	Operation	Explanation
1	Select {JOB} on the RESERVATION STATUS window.	
2	Select {RESET RESERVATION} or {RESET ALL}.	<p>When {RESET RESERVATION} is selected, job reservation stated to “RESERVE” is reset. When {RESET ALL} is selected, job reservation stated to “STOP” and “RESERVE” is reset.</p>  <p>The confirmation dialog box appears.</p> 
3	Select “YES.”	

NOTE All job reservations are reset automatically in the following conditions:

- When the reserved start sets to “PROHIBIT.” (When “RESERVED START” is set to “PROHIBIT” on the OPERATING CONDITION window.)
- When another job is called or an edit operation is performed.

4.5.3 Hold Operation

Hold operation causes the manipulator to stop all motion. It can be performed by the following buttons or signal.

- [HOLD] on the programming pendant
- External Input Signal (system input)
- Hold button for the station axis

■ [HOLD] on the Programming Pendant

Hold

	Operation	Explanation
1	Press [HOLD] on the programming pendant.	The manipulator stops temporarily. The [HOLD] lamp lights while the [HOLD] button is held down.

Release

	Operation	Explanation
1	Press the start button on the suspended station.	The manipulator restarts its operation from the position where it was stopped,.

■ Hold by External Input Signal (System Input)

Hold

	Operation	Explanation
1	Input ON signal to the external input (system input) specified for hold operation.	The manipulator stops temporarily.  External holding The hold lamp for the external output signal lights. The [HOLD] lamp on the programming pendant lights and the [START] lamp turns OFF.

Release

	Operation	Explanation
1	Input OFF signal to the external input (system input) specified for hold operation.	Hold is released. To continue the operation, press the start button on the suspended station. The manipulator restarts its operation from the position where it was stopped.

■ Hold at the Station

Hold

	Operation	Explanation
1	Press the hold button on the station.	The manipulator stops temporarily. 

Release

	Operation	Explanation
1	Press the hold button on the suspended station.	Hold is released. Press the start button on the station, then the manipulator restarts its operation from the position where it was stopped.



Pressing the start button on a station that is not in Hold status does not start manipulator operation. The job registered for the station is reserved or the reservation, if it has been made, is canceled.

4.6 Displaying Job Stack

During execution of the series of jobs that combined with CALL or JUMP instructions, the job stack can be displayed to check where the current job is and how many jobs left.

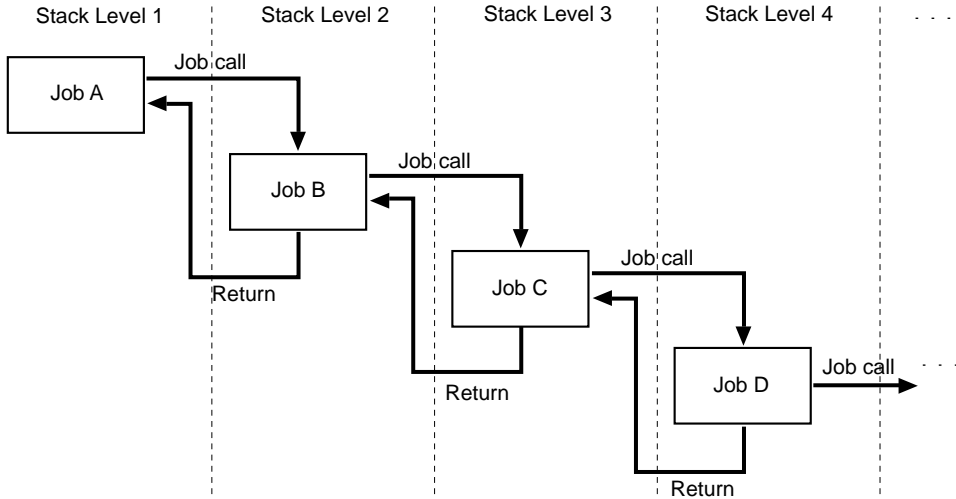

SUPPLEMENT Job calls can be used for up to 8 stack levels. (Up to 10 from NS3.00)

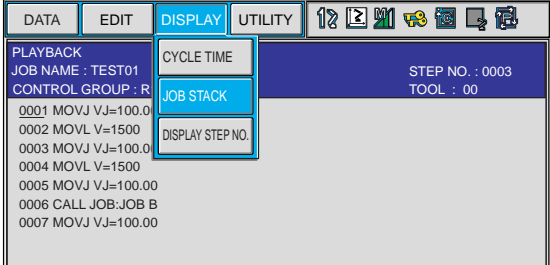
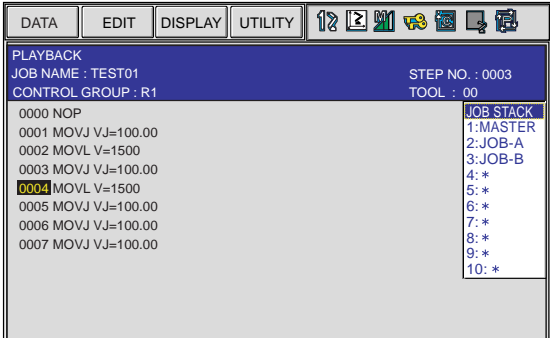
	Operation	Explanation
1	Select {DISPLAY} under the menu on the PLAYBACK window.	The pull-down menu appears. 
2	Select {JOB STACK}.	The job stack status dialog box appears. To close the job stack status dialog box, select {DISPLAY} and then {JOB STACK} under the menu again.  <p>For above example, the playback of Job C is being executed and the Job C is called from Job B. Also, the Job B is called from Job A.</p>

5 Editing Jobs

This section explains how to manage the jobs without moving the manipulator. Copying, deleting, and modifying of the jobs can be done in the teach mode only. Other operations can be done in any mode.



Edit operations are restricted when the edit lock is applied.



Editing Move Instructions

See " 3 Teaching " for basic information on editing move instructions. It is not possible to add, delete, or modify move instructions which have position data. See " 3.4 Modifying Steps " for details.

The following MOV instruction edit operations are explained in this section:

For move instructions:

- Insertion, deletion, or modification of additional items
- Modification of interpolation type or play speed for move instructions
- Setting, modification, or deletion of UNTIL statements (interruption conditions based on input signals)
- Setting and deletion of NWAIT instructions

For move instructions using position variables:



- Insertion and deletion of move instruction.

5.1 Copying Jobs

This operation is used to copy registered jobs and use them to create new jobs. It can be done using either the JOB CONTENT window or the JOB LIST window.

5.1.1 Copying Jobs on the JOB CONTENT Window

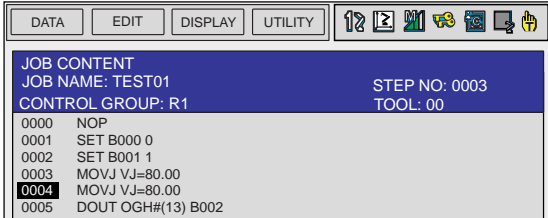
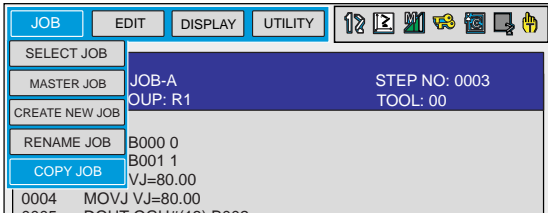
On the JOB CONTENT window, the current edit job becomes the copy source job.

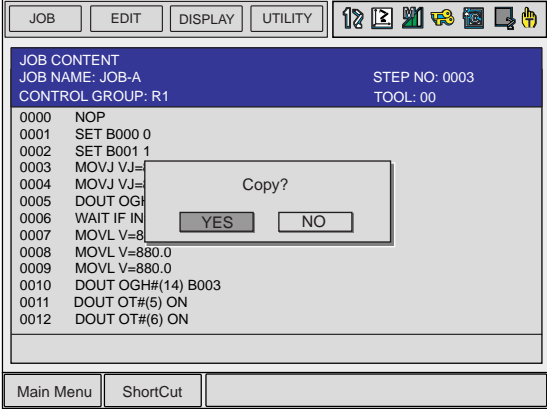

	Operation	Explanation
1	Select {JOB} under the main menu.	
2	Select {JOB}.	<p>The JOB CONTENT window appears.</p>  <p>The screenshot shows a window titled 'JOB CONTENT' with a menu bar containing 'DATA', 'EDIT', 'DISPLAY', and 'UTILITY'. Below the menu bar, the job name is 'TEST01' and the step number is '0003'. The control group is 'R1' and the tool is '00'. The job steps are listed as follows:</p> <pre> 0000 NOP 0001 SET B000 0 0002 SET B001 1 0003 MOVJ VJ=80.00 0004 MOVJ VJ=80.00 0005 DOUT OGH#(13) B002 </pre>
3	Select {JOB} under the menu.	<p>The pull-down menu appears.</p>  <p>The screenshot shows the same 'JOB CONTENT' window, but with a pull-down menu open. The menu items are: 'SELECT JOB', 'MASTER JOB', 'CREATE NEW JOB', 'RENAME JOB', 'COPY JOB', and 'JOB-A'. The 'COPY JOB' item is highlighted. The job details for 'JOB-A' are shown: 'STEP NO: 0003' and 'TOOL: 00'. The job steps are listed as follows:</p> <pre> B000 0 B001 1 VJ=80.00 0004 MOVJ VJ=80.00 </pre>
4	Select {COPY JOB} under the pull-down menu.	
5	Input the new job name.	<p>The name of the copy source job is displayed on the input area. It is possible to partially change this name to enter a new name.</p>  <p>The screenshot shows an input field with the text '> JOB-B' and a cursor at the end.</p> <div style="border: 1px solid black; padding: 5px; margin-top: 10px;">  See " 1.2.6 Character Input " for information on letter input operations. </div>

5.1 Copying Jobs

	Operation	Explanation
6	Press [ENTER].	<p>The confirmation dialog box appears.</p> <p>If "YES" is selected, the job is copied and the new job appears.</p> <p>If "NO" is selected, the job copy is not executed, and the process is cancelled.</p>  <p>The screenshot shows a CNC control interface. At the top, there are buttons for 'JOB', 'EDIT', 'DISPLAY', and 'UTILITY', along with several icons. Below this is a header area with 'JOB CONTENT', 'JOB NAME: JOB-A', 'CONTROL GROUP: R1', 'STEP NO: 0003', and 'TOOL: 00'. The main area displays a list of program steps: 0000 NOP, 0001 SET B000 0, 0002 SET B001 1, 0003 MOVJ VJ=, 0004 MOVJ VJ=, 0005 DOUT OGH, 0006 WAIT IF IN, 0007 MOVL V=8, 0008 MOVL V=880.0, 0009 MOVL V=880.0, 0010 DOUT OGH#(14) B003, 0011 DOUT OT#(5) ON, and 0012 DOUT OT#(6) ON. A 'Copy?' dialog box with 'YES' and 'NO' buttons is overlaid on the program list. At the bottom, there are 'Main Menu' and 'ShortCut' buttons.</p>

5.1.2 Copying Jobs on the JOB LIST Window

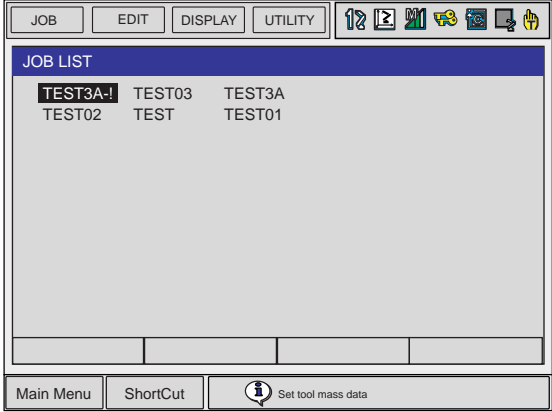
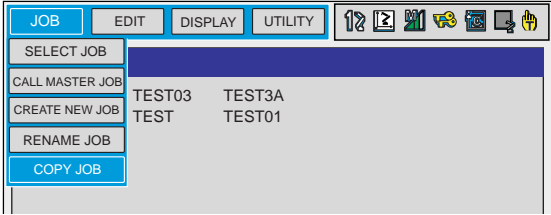
On the JOB LIST window, select the copy source job from the registered jobs and specify the copy destination directory.

	Operation	Explanation
1	Select {JOB} under the main menu.	
2	Select {SELECT JOB} under the pull-down menu.	<p>The JOB LIST window appears.</p> 
3	Move the cursor to the copy source job.	
4	Select {JOB} under the menu.	
5	Select {COPY JOB} under the pull-down menu.	
6	Input the new job name.	<p>The name of the copy source job is displayed on the input area. It is possible to partially change this name to enter a new name.</p> <p>> JOB-B █</p> <div style="border: 1px solid black; padding: 5px; margin-top: 10px;">  See " 1.2.6 Character Input " for information on letter input operations. </div>

5.1 Copying Jobs

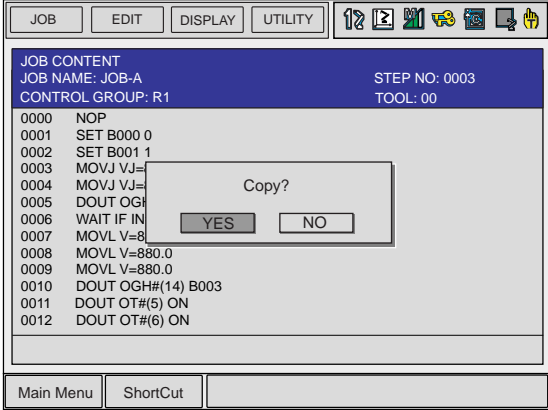
	Operation	Explanation
7	Press [ENTER].	<p>The confirmation dialog box appears.</p> <p>If "YES" is selected, the job is copied and the new job appears.</p> <p>If "NO" is selected, the job copy is not executed, and the process is cancelled.</p>  <p>The screenshot shows a CNC control screen with a menu bar at the top containing 'JOB', 'EDIT', 'DISPLAY', and 'UTILITY'. Below the menu bar is a status bar with 'JOB CONTENT', 'JOB NAME: JOB-A', 'CONTROL GROUP: R1', 'STEP NO: 0003', and 'TOOL: 00'. The main display area shows a list of operations from 0000 to 0012. A 'Copy?' dialog box is overlaid on the screen, with 'YES' and 'NO' buttons.</p>

5.2 Deleting Jobs

This operation is used to delete jobs that are registered on the NX100. It can be performed in either the JOB CONTENT window or the JOB LIST window.

5.2.1 Deleting Jobs on the JOB CONTENT Window

On the JOB CONTENT window, the current edit job is deleted.

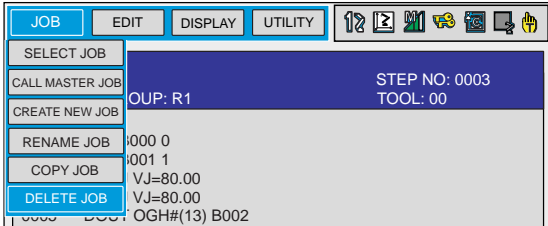
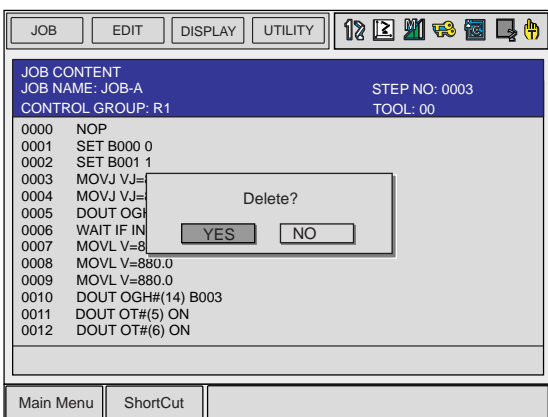
	Operation	Explanation
1	Select {JOB} under the main menu.	
2	Select {JOB}.	The JOB CONTENT window appears.
3	Select {JOB} from the menu.	The pull-down menu appears. 
4	Select {DELETE JOB} under the pull-down menu.	The confirmation dialog box appears. When "YES" is selected, the edit job is deleted. When deletion is completed, the JOB LIST window appears. When "NO" is selected, the job deletion is cancelled. 

5.2.2 Deleting Jobs on the JOB LIST Window

On the JOB LIST window, select the job to be deleted from the list of the registered jobs.

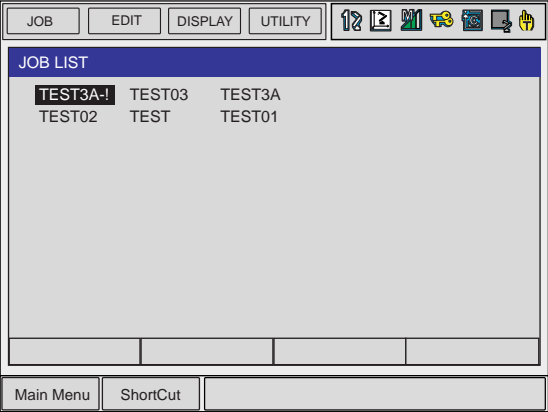
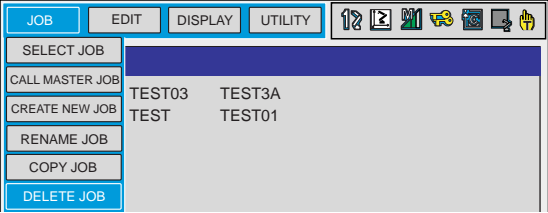
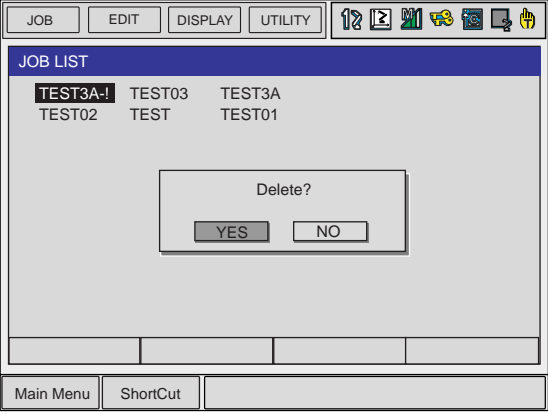
	Operation	Explanation
1	Select {JOB} under the main menu.	
2	Select {SELECT JOB}.	<p>The JOB LIST window appears.</p> 
3	Move the cursor to the job to be deleted.	
4	Select {JOB} from the menu.	
5	Select {DELETE JOB} under the pull-down menu.	<p>The confirmation dialog box appears.</p>  <p>If "NO" or [CANCEL] is selected, the job deletion is cancelled and the JOB LIST window appears.</p>
6	Select "YES."	



To select all the registered jobs at a time, select {EDIT} from the menu and then select "SELECT ALL."

5.3 Modifying Job Names

This operation is used to modify the name of a job that is registered. The operation can be performed in either the JOB CONTENT window or the JOB LIST window.

5.3.1 Modifying Job Names on the JOB CONTENT Window

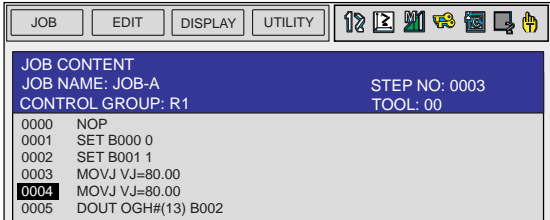
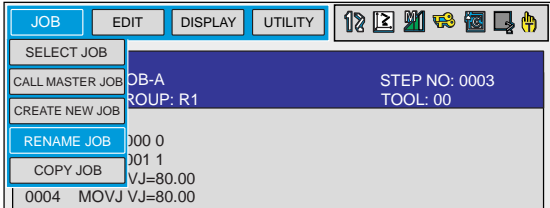
	Operation	Explanation
1	Select {JOB} under the main menu.	
2	Select {JOB}.	The JOB CONTENT window appears. 
3	Select {JOB} from the menu.	The pull-down menu appears. 
4	Select {RENAME JOB} under the pull-down menu.	

5.3 Modifying Job Names

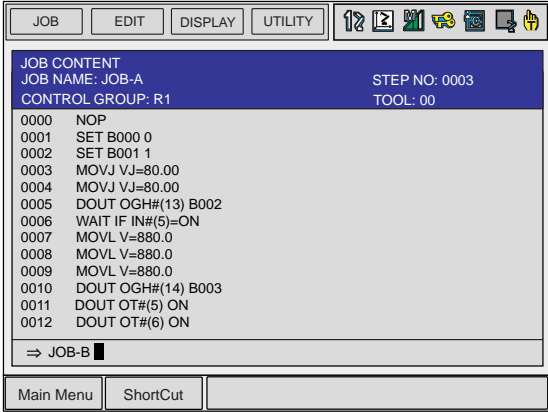
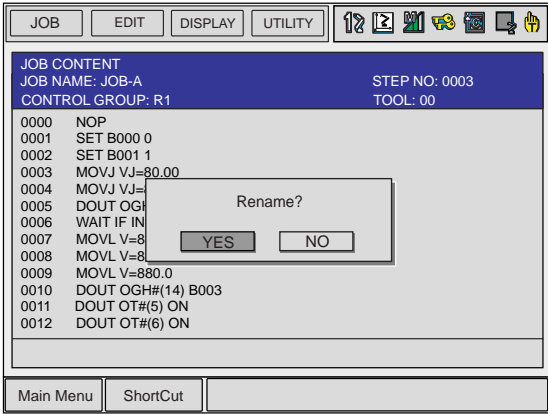
	Operation	Explanation
5	Input the job name.	<p>Input the new job name on the input area. The name of the source job is displayed on the input area. It is possible to partially change this name to enter a new name.</p> <div data-bbox="603 443 678 510" style="border: 1px solid black; padding: 2px;">  </div> <div data-bbox="719 443 1332 510" style="border: 1px solid black; padding: 2px;"> <p>See " 1.2.6 Character Input " for information on letter input operations.</p> </div> 
6	Press [ENTER].	<p>The confirmation dialog box appears. When "YES" is selected, the job name is changed and a new job name is displayed. When "NO" is selected, the job name is not changed, and the process is cancelled.</p> 



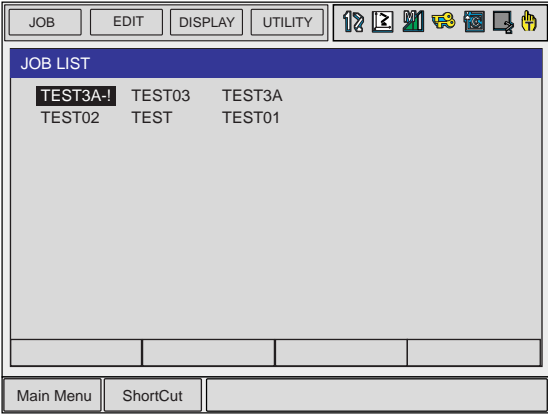
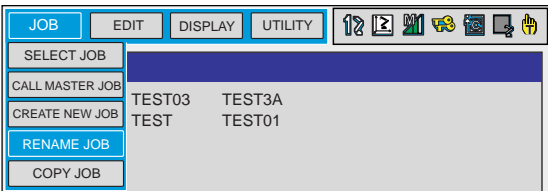
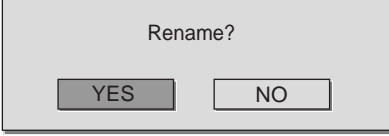

5.3.2 Modifying Job Names on the JOB LIST Window

On the JOB LIST window, select the job whose name is to be modified from the list of the registered jobs.

	Operation	Explanation
1	Select {JOB} under the main menu.	
2	Select {SELECT JOB}.	The JOB LIST window appears. 
3	Move the cursor to the name to be changed.	
4	Select {JOB} from the menu.	
5	Select {RENAME JOB} under the pull-down menu.	
6	Enter the job name and press [ENTER].	The confirmation dialog box appears. 
7	Select "YES."	

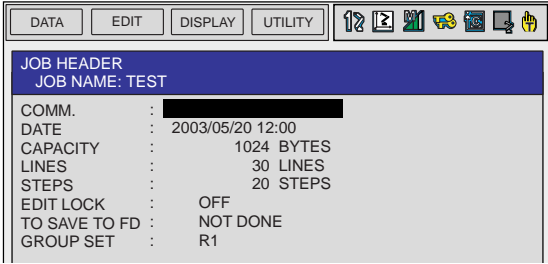
5.4 Editing Comments

Comments of up to 32 characters can be affixed to jobs to identify them more specifically. Comments are displayed and edited on the JOB HEADER window.

	Operation	Explanation
1	Select {JOB} under the main menu.	
2	Select {JOB}.	
3	Select {DISPLAY} under the pull-down menu.	
4	Select {JOB HEADER}.	<p>The JOB HEADER window appears.</p> 
5	Select "COMM."	The window for character input appears.
6	Input comments.	<p>For jobs that are already registered, comments are displayed on the input area. It is possible to partially change comments to enter new comments.</p>  <div style="border: 1px solid blue; padding: 5px; margin-top: 10px;">  See " 1.2.6 Character Input " for information on character input operations. </div>
7	Press [ENTER].	<p>The input area comment is registered and is displayed in the "COMM." area on the JOB HEADER window.</p> 

5.5 Setting Edit Lock on Individual Job Units

In order to prevent inadvertent changes in registered jobs or data, it is possible to apply an edit lock to individual jobs. When a job is protected from editing, the job cannot be edited or deleted. Edit lock is set and cancelled on the JOB HEADER window.

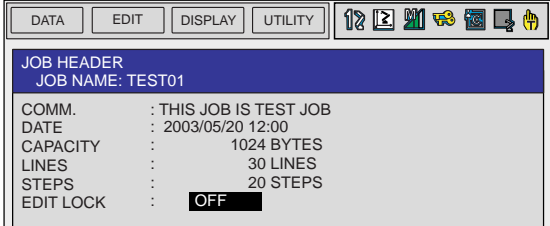
	Operation	Explanation
1	Select {JOB} under the main menu.	
2	Select {JOB}.	
3	Select {DISPLAY} under the pull-down menu.	
4	Select {JOB HEADER}.	The JOB HEADER window appears. 
5	Select "EDIT LOCK" and set the edit prohibit.	Each time [SELECT] is pressed, the setting alternates between "ON" (edit disabled) and "OFF" (edit enabled).

5.6 Enabling the Modification of Position Data Only

It is possible to set conditions to allow changes of position data only, in jobs which are locked.

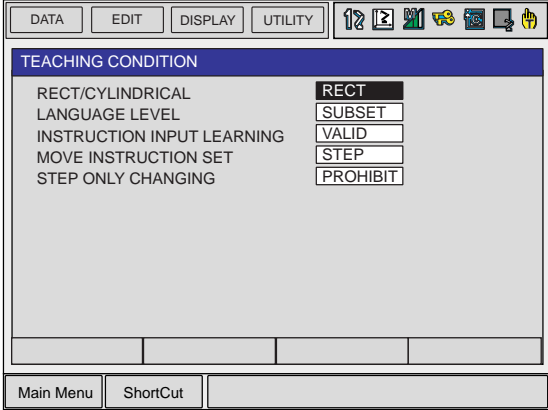
	Operation	Explanation
1	Select {SETUP} under the main menu.	
2	Select {TEACHING COND}.	<p>The TEACHING CONDITION window appears.</p>  <div style="border: 1px solid black; padding: 5px; margin-top: 10px;"> <p>NOTE TEACHING CONDITION window is shown only when the security mode is edit mode or management mode.</p> </div>
3	Select "STEP ONLY CHANGING."	
4	Press [SELECT].	Each time [SELECT] is pressed, the setting alternates between "PROHIBIT" and "PERMIT."

6 Convenient Functions

6.1 One-touch Operation "Direct Open"



The direct open function immediately shows the JOB CONTENT window or condition file contents of a job called with the CALL instruction. Move the cursor to the desired job name or

condition file name and simply press the direct open key  to display the contents of the file. This function can be used for the following window:

- JOB CONTENT window for a job name directly specified by a CALL instruction
- CONDITION FILE window for a file name directly specified by a work instruction
- COMMAND POS window for a move instruction
- I/O window with an I/O instruction (when I/O numbers are specified)

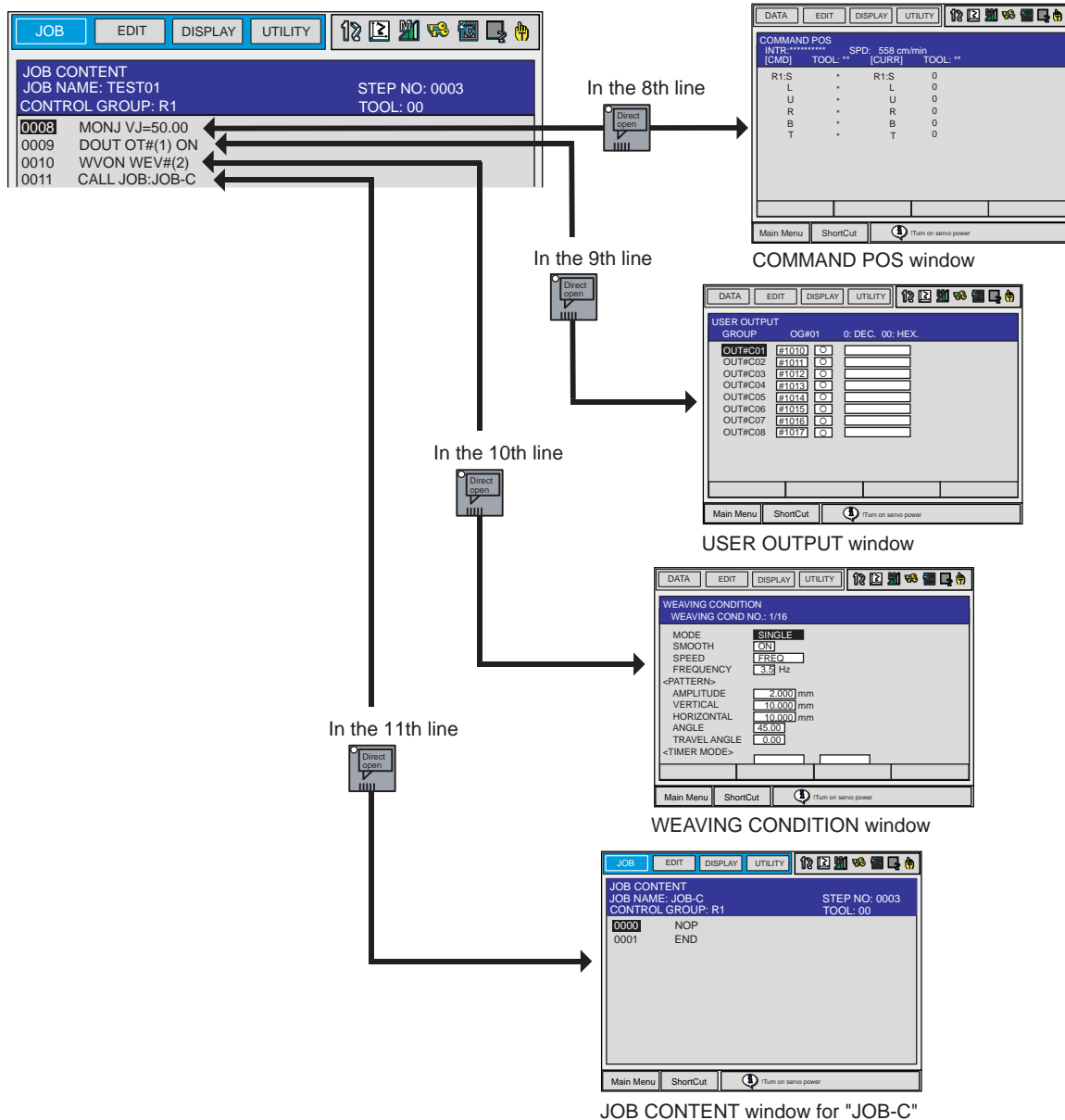
<Example> Example Using Direct Open



	Operation	Explanation
1	In the JOB CONTENT window, move the cursor to the job name or condition file for which the window is to be displayed.	
2	Press the direct open key  .	This key lamp lights and the JOB CONTENT window or the condition file window appears. When the direct open key  is pressed once more, the key lamp turns OFF, and the window returns to the former JOB CONTENT window.

NOTE

- The direct open function cannot be used again while a directly opened window is shown.
- If another window is selected while the direct open function is effective, the function is automatically cancelled and the lamp on the direct open key goes out.
- Once another JOB CONTENT window is opened by the direct open function, the source job cannot be continuously operated. (Stopped until the opened JOB CONTENT window is closed.)

6.2 Parallel Shift Function

6.2.1 Function Overview

Parallel shift refers to the shifting of an object from a fixed position in such a way that all points within the object move an equal distance. In the model for parallel shift shown in the following, the shift value can be defined as the distance L (three-dimensional coordinate displacement). The parallel shift function is relevant to the actual operation of the manipulator because it can be used to reduce the amount of work involved in teaching by shifting a taught path (or position).

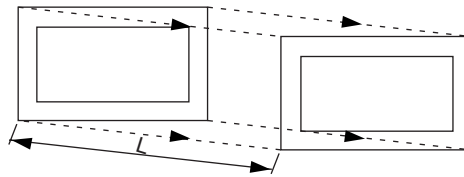

In the example in the figure below, the taught position A is shifted in increments of the distance L (this is actually a three-dimensional XYZ displacement that can be recognized by the robot) in order to enable the operation that was taught at position A to also be performed at positions B through G.

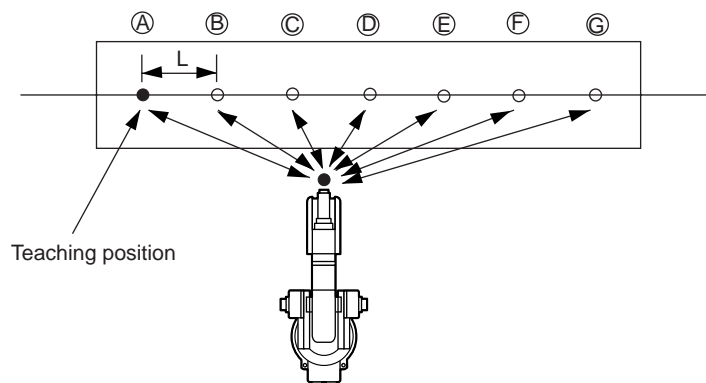

6.2 Parallel Shift Function

The block from the SFTON to the SFTOF instructions is subject to the shift operation.

Line (Step)	Instruction
0000	NOP
0001(001)	MOVJ VJ=50.00
0002(002)	MOVL V=138
0003	SFTON P□□□UF# (1)
0004(003)	MOVL V=138
0005(004)	MOVL V=138
0006(005)	MOVL V=138
0007	SFTOF
0008(006)	MOVL V=138

} Shifted block

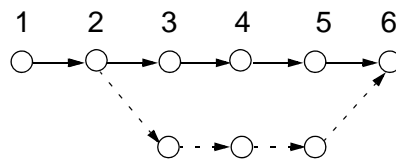

When shifting an entire series of operations, the range to be shifted by the shift instruction can be set using the method indicated above, but the method shown in the following, in which just the part to be shifted is made into a separate job, can also be used.

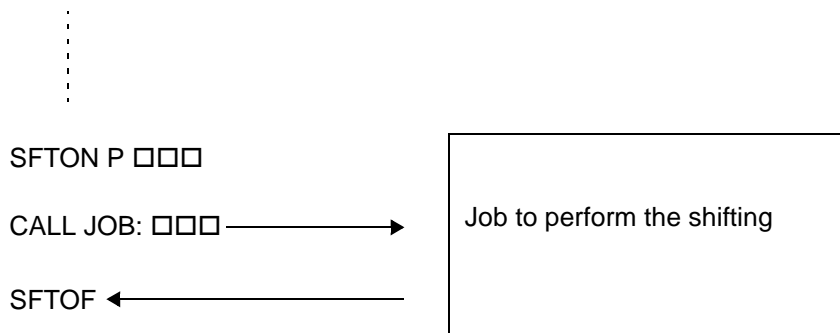

6.2.2 Setting the Shift Value

■ Registering Position Variables

The NX100 has 128 position variables (P000 to P127); these can be used to define parallel shift values. When using the parallel shift function, it is necessary to measure the distance between the teaching point and the shift destination position (XYZ displacement of each coordinate) and then register this in advance as a position variable.

When the shift instruction is executed in playback, the operation is performed at a location shifted from the taught position by the amount registered for the specified position variable. The POSITION VARIABLE window is shown in the following.

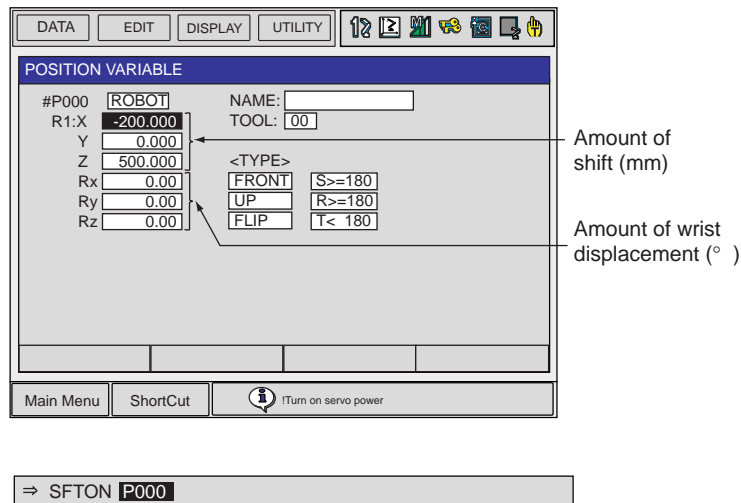

■ Coordinate Systems

The shift value for parallel shift is X, Y, and Z increment in each coordinates. There are four coordinates: base coordinates, robot coordinates, tool coordinates, and user coordinates. In systems with no servo track, the base coordinates and robot coordinates are the same.

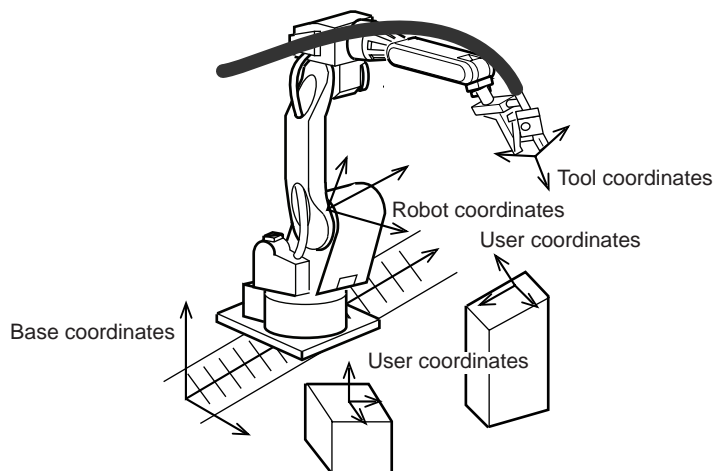

■ Setting the Shift Value

When setting the shift value for the position variables, use the current position (coordinates) of the manipulator in the window.

The figure shows three screenshots of the robot control interface. The first screenshot, labeled "Teaching position", displays the "CUR POS COORDINATE" window with the following data:

COORDINATE	USER COORD #01	TOOL: 00
R1: X	5.360 mm	Rx -179.91 deg
Y	66.080 mm	Ry -2.17 deg
Z	316.940 mm	Rz -102.89 deg

The second screenshot, labeled "Position to be shifted", shows the same window after the manipulator has been moved to a new position:

COORDINATE	USER COORD #01	TOOL: 00
R1: X	105.360 mm	Rx -179.91 deg
Y	66.080 mm	Ry -2.17 deg
Z	416.940 mm	Rz -102.89 deg

The third screenshot shows the "POSITION VARIABLE" window for #P000, where the shift values are set:

R1:X	-100.000	Y	0.000	Z	-100.000	Rx	0.00	Ry	0.00	Rz	0.00
------	----------	---	-------	---	----------	----	------	----	------	----	------

Additional settings in the window include: NAME: [], TOOL: [00], and wrist posture options: FRONT (S>=180), UP (R>=180), and FLIP (T< 180).

The shift value is the X, Y, and Z difference between the shift position and teaching position and the difference in angular displacement RX, RY, And RZ (normally set at "0"). If shifting is executed at equal pitch intervals, for example for palletizing, find the difference between the teaching position and the final shift position, then divide by the number of pitch intervals (number of divisions) to calculate the shift value per pitch.

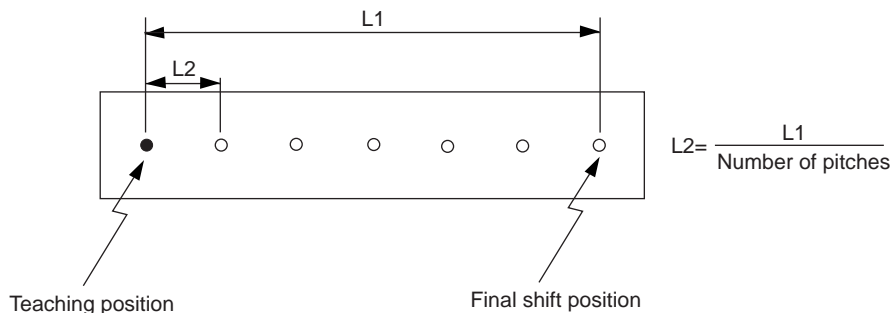

The posture of the wrist is defined by the angular displacement of the coordinates of the wrist axes. Consequently, if the shift value is specified with X, Y, and Z only (RX, RY, RZ=0), the wrist is shifted while maintaining the same posture as at the teaching point. Since shifting is normally performed without changing the posture, there is no need to specify an angular displacement for the wrist. The motion when a parallel shift is performed is shown in the following:

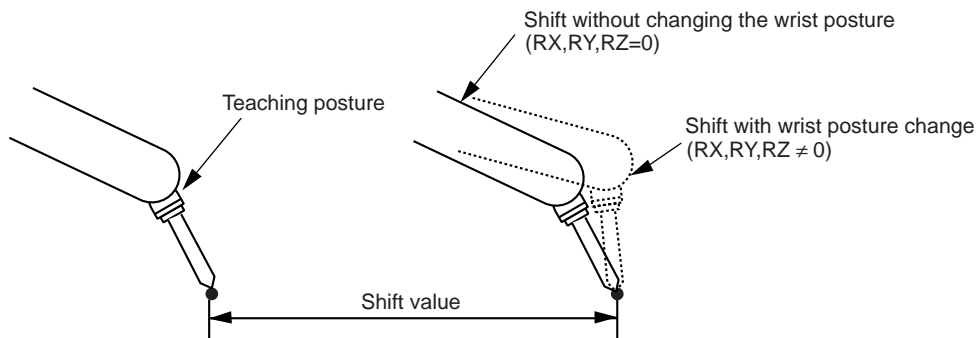

The shift value is calculated on the position data window for the coordinates in which the shift is performed. Since this is normally performed in the user coordinates, the position data window for the user coordinates is used.

6.2.3 Registering Shift Instructions

To register the instruction, move the cursor to the address area in the JOB CONTENT window during teach mode as follows:

	Operation	Explanation
1	Select {JOB} under the main menu.	
2	Select {JOB}.	<p>The JOB CONTENT window appears.</p>
3	Move the cursor to the address area.	

■ SFTON Instruction

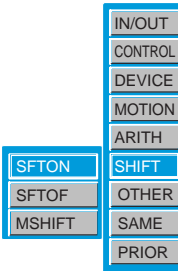

This is the instruction that starts a parallel shift.

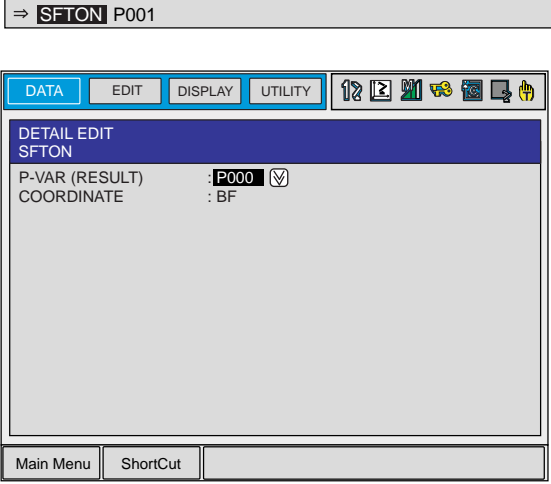
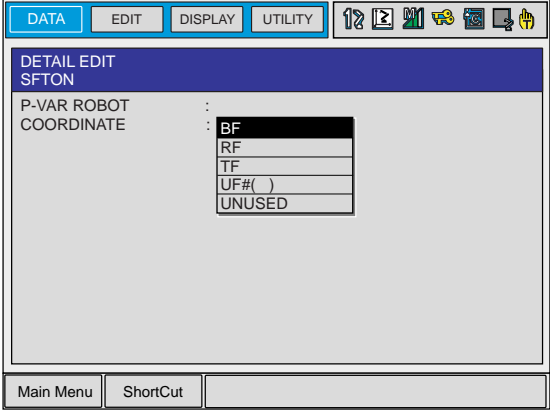
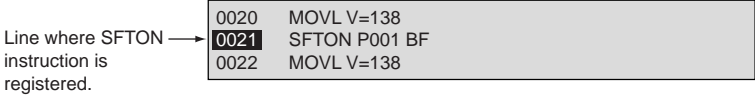
	Operation	Explanation
1	Move the cursor to the line immediately before where the SFTON instruction is to be registered.	<p>Line immediately before where SFTON instruction is to be registered. →</p> <div style="border: 1px solid black; padding: 5px; width: fit-content;"> <pre>0020 MOVL V=138 0021 MOVL V=138 0022 MOVL V=138</pre> </div>
2	Press [INFORM LIST].	<p>The instruction list dialog box appears.</p> <div style="text-align: center;">  </div>
3	Select {SHIFT}.	
4	Select the SFTON instruction.	The SFTON instruction is displayed in the input buffer line.
5	Modify the additional items or number values as required.	<p><When Nothing is to be Changed> Proceed to Step 6.</p> <p><When Editing Additional Items></p> <ul style="list-style-type: none"> • Adding or modifying additional items To change the position variable number, move the cursor to the position variable number and press [SHIFT] + the cursor key to increase or decrease the value. <div style="border: 1px solid black; padding: 5px; width: fit-content; margin: 10px auto;"> <p>⇒ SFTON P000</p> </div> <p>To directly input the value using the Numeric keys, press [SELECT] to display the input buffer line.</p> <div style="border: 1px solid black; padding: 5px; width: fit-content; margin: 10px auto;"> <p>P =</p> <p>⇒ SFTON █</p> </div> <p>After the number is input, press [ENTER] to modify the number value in the input buffer line.</p>

	Operation	Explanation
5	(cont'd)	<ul style="list-style-type: none"> Adding the coordinate system in which the shift is performed <p>Move the cursor to the instruction in the input buffer line and press [SELECT]. The DETAIL EDIT window appears.</p>  <p>Line up the cursor with "UNUSED" and press [SELECT]. The selection dialog box appears. Line up the cursor with the coordinate system to be added, and press [SELECT].</p>  <p>After the coordinate system addition is completed, press [ENTER]. The DETAIL EDIT window closes and the JOB CONTENT window appears.</p>
6	Press [INSERT] and then [ENTER].	<p>The instruction displayed in the input buffer line is registered.</p> 

■ SFTOF Instruction

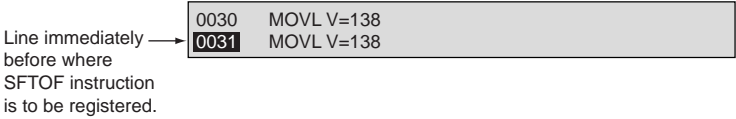
This is the instruction that ends a parallel shift.



	Operation	Explanation
1	Move the cursor to the line immediately before where the SFTOF instruction is to be registered.	 <p>Line immediately before where SFTOF instruction is to be registered.</p> <pre>0030 MOVL V=138 0031 MOVL V=138</pre>
2	Press [INFORM LIST].	The instruction list dialog box appears.
3	Select {SHIFT}.	
4	Select the SFTOF instruction.	The SFTOF instruction is displayed in the input buffer line. 
5	Press [INSERT] and then [ENTER].	The SFTOF instruction is registered.  <pre>0030 MOVL V=138 0031 SFTOF 0032 MOVL V=138</pre>

■ MSHIFT Instruction

When a parallel shift of the wrist posture is attempted, the manipulator may not be shifted to the target posture in the following cases.

- Posture displacement (Rx, Ry, Rz) is specified to the shift value set by the user.
- When a displacement between two points is calculated using an INFORM operating instruction (ADD instruction, SUB instruction, etc.), and a posture displacement (Rx, Ry, Rz) is specified in the shift value.

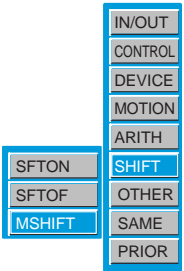
In such cases, the MSHIFT instruction can be used to automatically calculate the optimum shift value for an operation to reach the target shift position and posture. With an MSHIFT instruction, the shift value between the reference position and target position (shift position) when parallel shift is performed is determined in the specified coordinate system, and set as the specified position variable.

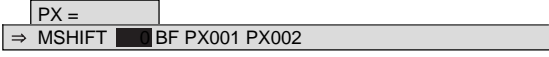
	Operation	Explanation
1	Move the cursor to the line immediately before where the MSHIFT instruction is to be registered.	<p>Line immediately before where MSHIFT instruction is registered. →</p> <pre> 0003 MOVJ VJ=10.00 0004 GETS PX001 \$PX000 0005 END </pre>
2	Press [INFORM LIST].	<p>The instruction list dialog box appears.</p> 
3	Select {SHIFT}.	
4	Select the MSHIFT instruction.	The MSHIFT instruction is displayed in the input buffer line.
5	Change the number data or additional items as required.	<p><When Nothing is to be Changed> Proceed to Step 6.</p> <p><When Editing Additional Items></p> <ul style="list-style-type: none"> • Adding or modifying additional items <p>To change the position variable number, move the cursor to the position variable number and press [SHIFT] + the cursor key to increase or decrease the value.</p>  <p>To directly input the value using the Numeric keys, press [SELECT] to display the input buffer line.</p>  <p>After the number is input, press [ENTER] to modify the number value in the input buffer line.</p>

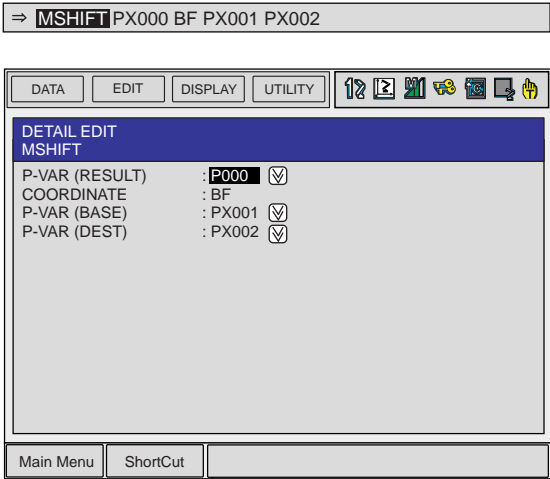
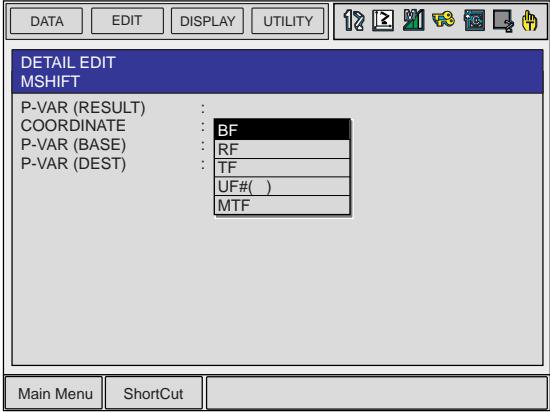
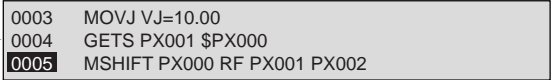
	Operation	Explanation
5	(cont'd)	<p>• Changing the coordinate system in which the shift is performed Move the cursor to the instruction in the input buffer line and press [SELECT]. The DETAIL EDIT window appears.</p>  <p>Line up the cursor with “BF” and press [SELECT]. The selection dialog box appears. Line up the cursor with the coordinate system to be changed, and press [SELECT].</p>  <p>After the coordinate system modification is complete, press [ENTER]. The DETAIL EDIT window closes and the JOB CONTENT window appears.</p>
6	Press [INSERT] and then [ENTER].	<p>The instruction displayed in the input buffer line is registered.</p>  <p>Line where MSHIFT is registered. →</p>

6.2.4 Continuation of the Parallel Shift Function



CAUTION

- **If the shift function is cancelled through a job editing operation after execution of a parallel shift instruction, the job must be started again from the beginning.**

Because no shift is performed when the operation is restarted, there is a possibility of interference between the workpiece and fixture.

If any of the following operations are performed after executing a parallel shift instruction, the shift function is cancelled.

- Job editing operation (changing, deleting, adding)
- Job copy, job name change
- Registering a new job, deleting a job, or modifying a selected job
- Restart after the alarm occurs
- When control power is turned OFF



The parallel shift function remains in effect even if the control power supply is turned OFF.

6.2.5 Examples of Use

■ Example of Use of Shift Addition/Subtraction

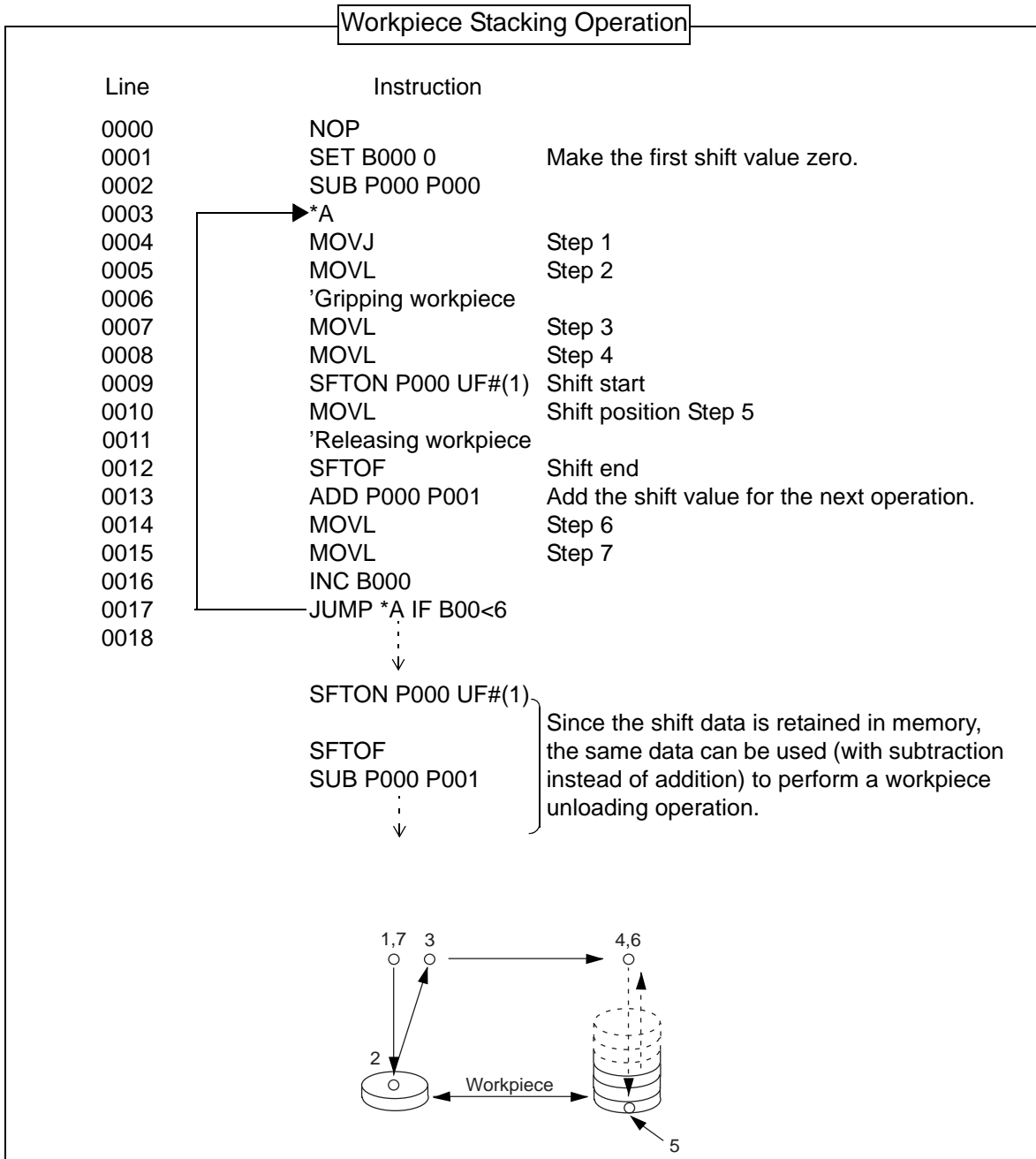

■ Example of Use of MSHIFT Instruction

Line	Instruction	Explanation
0000	NOP	
0001	MOVJ VJ=20.00	Move the manipulator to the reference position.
0002	GETS PX000 \$PX000	Set the reference position as position variable P000.
0003	MOVJ VJ=20.00	Move the manipulator to the target position.
0004	GETS PX001 \$PX000	Set the target position as position variable P001.
0005	MSHIFT PX010 BF PX000 PX001	Set shift value and set it as position variable P010.
0006	END	

6.3 Parallel Shift Job Conversion Function

6.3.1 Function Overview

If the manipulator and base positions are moved after a job has been taught, the entire job has to be modified. The parallel shift conversion function shortens the modification time required in cases like this by shifting all steps of the job by the same value to create a new job.

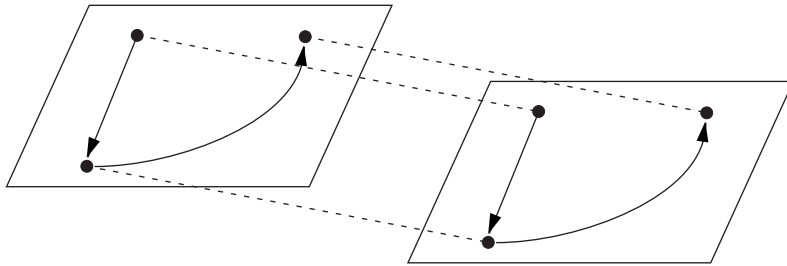

When parallel shift conversion is performed, all job steps are shifted by the same value.



Steps Outside the P-point Maximum Envelope

“/OV” is displayed for steps which result in a position outside the P-point maximum envelope of the manipulator. When the position is corrected, “/OV” display disappears.

Position Variable

Position variables are not subject to parallel shift job conversion.

Not Converted Job

The following jobs cannot be converted. If conversion is attempted, no operation is performed.

- Jobs without any group axes
- Concurrent jobs (optional)



If a job name after conversion is not specified when executing parallel shift job conversion, the position data of the job is shifted and converted, then the data is overwritten with a new position data after the shift. Be sure to save the job in the external memory device or create the same job by copying before executing conversion.

6.3.2 Coordinate Systems for Conversion

When performing parallel shift job conversion, it is necessary to specify the coordinate systems in which the conversion is to be performed. The coordinate system can be selected from the following:

- Base coordinates
- Robot coordinates
- Tool coordinates
- User coordinates (24 types)
- Master tool coordinates (R*+R* job)
- Joint coordinates

In the case of an ordinary job for which group axes are registered, shift conversion is performed in accordance with the selected coordinate system. The relationship between group combinations and coordinates are shown in the following table.

① to ④ in the table are followed by their explanations.

Relationship Between Group Combinations and Coordinates at Conversion

Group Combination in Job	Explanation	
	Usable Coordinate System	
R	Shift is performed on basis of selected coordinates. Base coordinates, robot coordinates, tool coordinates, user coordinates, pulse coordinates	
R(B)	Shift is performed on basis of selected coordinates.	
	①Base Coordinates	The base axis is shifted by the specified amount and the TCP of the manipulator is shifted by the specified amount in the base coordinates.
	②Robot Coordinates	The base axis is shifted by the specified amount. The TCP of the manipulator is shifted by the specified amount in the robot coordinates. These shifts are carried out independently.
	③Tool Coordinates	The base axis is shifted by the specified amount. The TCP of the manipulator is shifted by the specified amount in the tool coordinates. These shifts are carried out independently.
	④User Coordinates	The base axis is shifted by the specified amount and the TCP of the manipulator is shifted by the specified amount in the user coordinates.
	⑤Pulse Coordinates	The taught position of each axis is shifted by the specified amount on the basis of pulse values.
S	Shift is performed on the basis of pulse values regardless of the coordinates.	

6.3 Parallel Shift Job Conversion Function

Relationship Between Group Combinations and Coordinates at Conversion

Group Combination in Job	Explanation
	Usable Coordinate System
R+S	<p>The manipulator is shifted in the selected coordinates. The station axis is shifted on the basis of pulse values regardless of the coordinates.</p> <p>Base coordinates, robot coordinates, tool coordinates, user coordinates, pulse coordinates</p>
R(B)+S	<p>The manipulator is shifted in the selected coordinates, as in ① to ⑤ above. The station axis is shifted on the basis of pulse values regardless of the coordinates.</p>
R+R	<p>Two manipulators are shifted in the selected coordinates.</p> <p>Base coordinates, robot coordinates, tool coordinates, user coordinates, master tool coordinates ^{*1}, pulse coordinates</p>
R(B)+R(B)	<p>Two manipulators are shifted in the selected coordinate system, as in ① to ⑤ above. Two base axes are also shifted.</p>

***1** In the master tool coordinates, conversion only occurs at the “slave” from the standpoint of the SMOV instruction.

① Base Coordinates

The base axis is shifted by B and the TCP of the manipulator is shifted by A in the base coordinates.

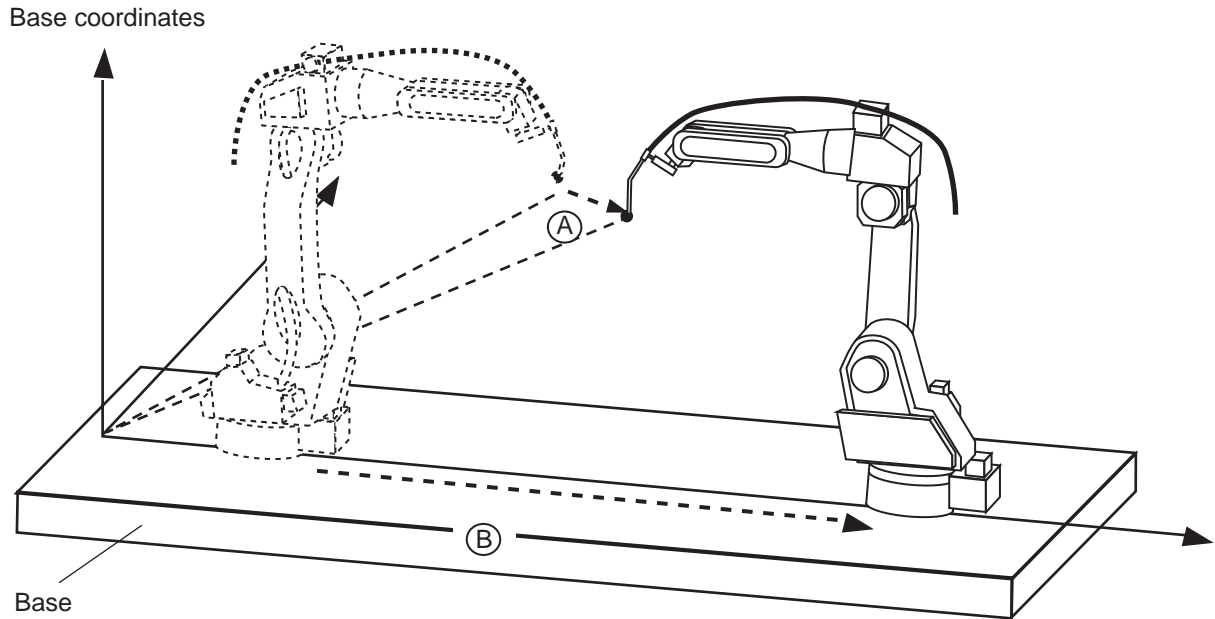
**② Robot Coordinates**

The base axis is shifted by B. The TCP of the manipulator is shifted by A in the robot coordinates. These shifts are carried out independently.

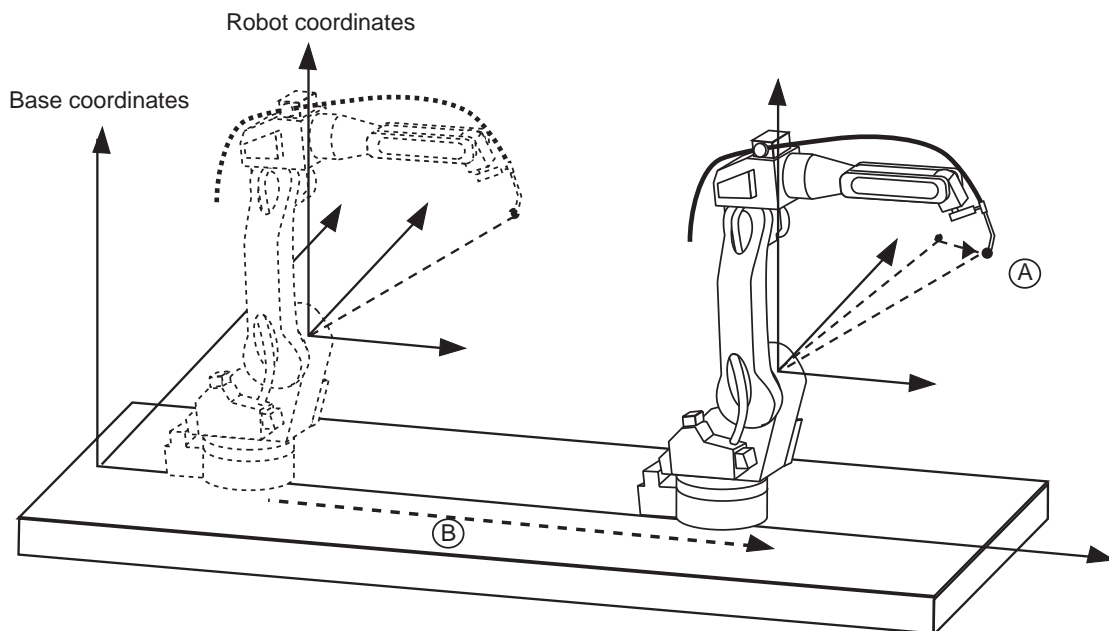

③ Tool Coordinates

The base axis is shifted by B and the TCP of the manipulator is shifted by A in the tool coordinates. These shifts are carried out independently.

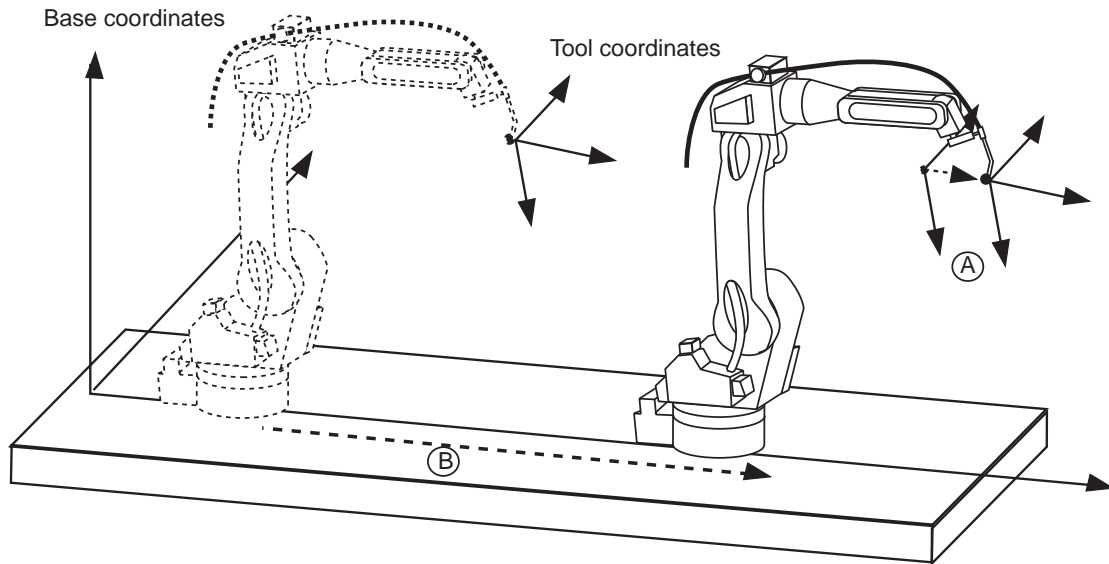

④ User Coordinates

The base axis is shifted by B and the TCP of the manipulator is shifted by A in the user coordinates. These shifts are carried out independently.

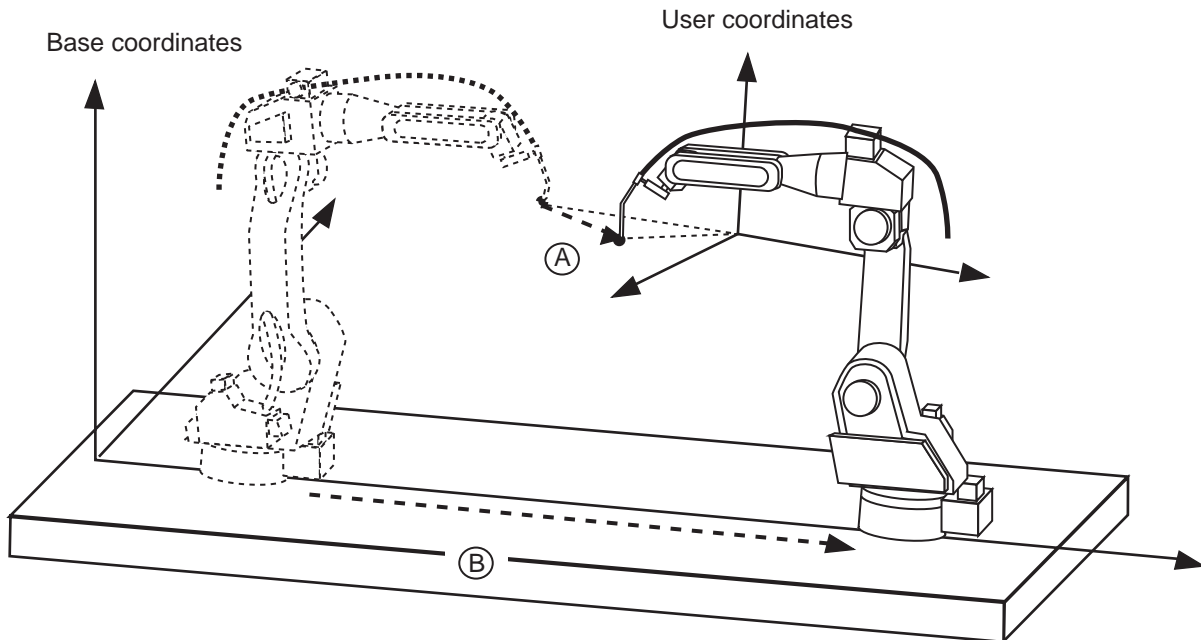

Converting R*+R* Jobs with Master Tool Coordinates

R*+R* coordinated jobs can be subjected to parallel shift job conversion in the master tool coordinates. Only steps taken at the “slave” from the standpoint of the SMOV instruction are subject to conversion (i.e. the steps of R2 in the figure below).

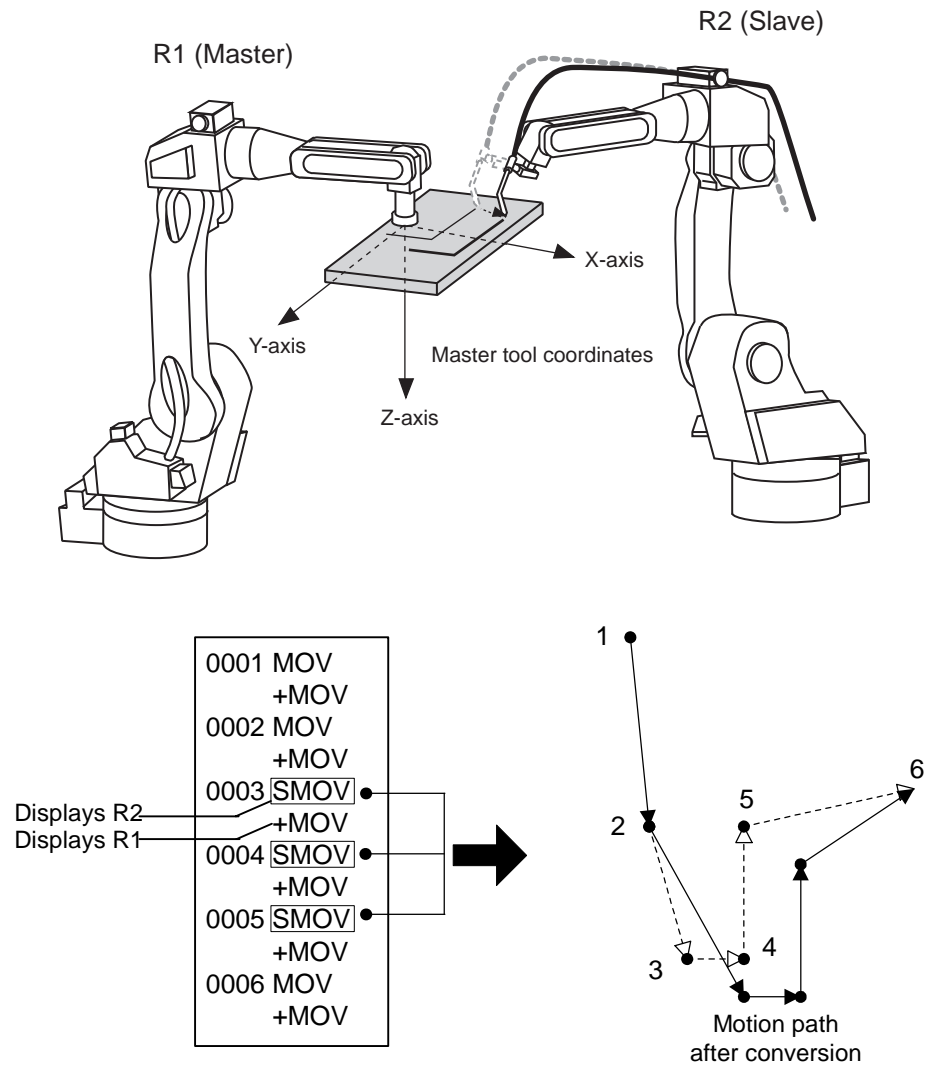

6.3.3 Executing the Parallel Shift Job Conversion

■ Window Display

PARALLEL SHIFT JOB	
SOURCE JOB	: JOB1
STEP SECTION	: 001 → 010
DESTINATION JOB	: *****
COORDINATES	: PULSE
BASE POINT	: TEACH SETTING
<SHIFT VALUE>	
R1:S	0
L	0
U	0
R	0
B	0
T	0

① SOURCE JOB

Selects the job before conversion. The job which is shown in the JOB CONTENT window is set initially. To change the job, perform the following procedure.

Move the cursor to the job name and press [SELECT]. The JOB LIST window appears. Select the desired job.

② STEP SECTION (Start Step → End Step)

Specifies the step section of the source job. All the steps are set initially. If there is no steps in the source job, "*****" is displayed. To change the section, perform the following procedure.

Move the cursor to the step section indication and press [SELECT]. The input buffer line appears. Input the step number and press [ENTER].

③ DESTINATION JOB

Specifies the converted job. If this is not specified ("*****" is displayed), the source job is overwritten with a job after conversion. If the converted job is specified, the source job is copied and converted. To change the job, perform the following procedure.

Move the cursor to the converted job name indication and press [SELECT]. The character input line appears. The source job name is displayed in the input line. To enter job name without using the source job name, press [CANCEL] and then input a job name.

④ COORDINATES

Selects the conversion coordinates. Move the cursor to the coordinates name and press [SELECT]. The selection dialog box appears. Select the desired coordinates.

When the user coordinates are selected, the input buffer line appears. Input the desired user coordinate number and press [ENTER].

⑤ BASE POINT

Calculates the difference by the two teaching points as a shift value.

⑥ SHIFT VALUE

The axis shown is varied according to the setting of "④coordinates" above.

Move the cursor to the input box and press [SELECT] to directly input the shift value.

If the shift value is calculated by the two teaching points, the difference is shown as a shift value.

■ Parallel Shift Job Conversion Operation

There are two methods for specifying the shift value.

- Directly input the shift value by numerical value.
- Calculate the shift value by teaching the original base point and converted base point.



The method using position variables by parameter setting is described in " 6.3.4 Specifying the Shift Value by Position Variables " other than above two methods.

The following are the operation procedures by each setting of shift value for parallel shift job conversion.

Numerical Value Input

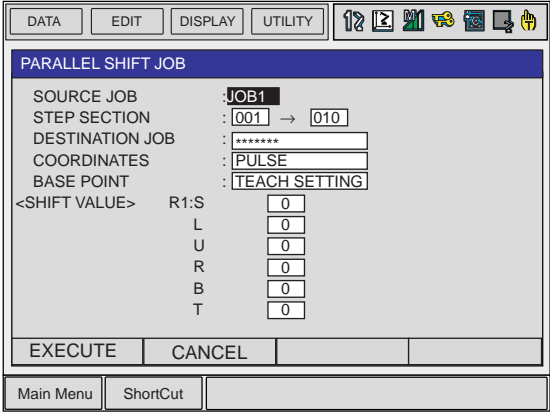
	Operation	Explanation
1	Select {JOB} under the main menu.	
2	Select {JOB}.	The JOB CONTENT window appears.
3	Select {UTILITY} under the pull-down menu.	
4	Select {PARALLEL SHIFT JOB}.	The PARALLEL SHIFT JOB window appears. 
5	Specify the conversion items.	Specify each item.

6.3 Parallel Shift Job Conversion Function

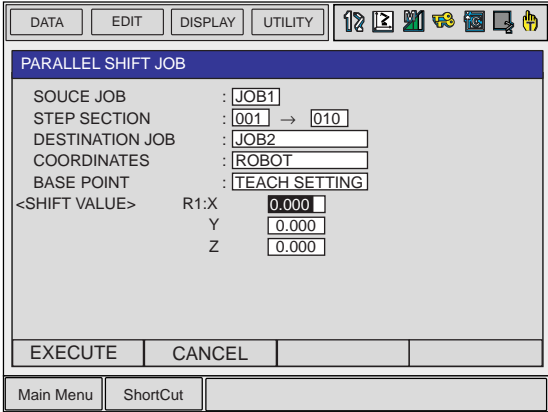
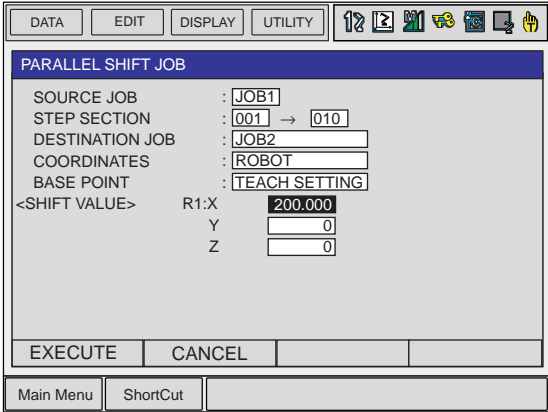
	Operation	Explanation
6	Select the shift value to be set.	<p>The number can be entered.</p>  <p>The screenshot shows a software interface titled "PARALLEL SHIFT JOB". It contains several input fields: SOURCE JOB (JOB1), STEP SECTION (001 → 010), DESTINATION JOB (JOB2), COORDINATES (ROBOT), and BASE POINT (TEACH SETTING). Under the heading "<SHIFT VALUE>", there are three input fields for R1:X, Y, and Z. The R1:X field contains the value "0.000". At the bottom, there are buttons for "EXECUTE" and "CANCEL", and a "Main Menu" button.</p>
7	Type the shift value using the Numeric keys.	
8	Press [ENTER].	<p>The shift value is set.</p>  <p>The screenshot shows the same "PARALLEL SHIFT JOB" interface as in step 6. The R1:X coordinate field now contains the value "200.000". The Y and Z fields are empty. The "EXECUTE" and "CANCEL" buttons are visible at the bottom.</p>

	Operation	Explanation
9	Display the PARALLEL SHIFT JOB window. Select "EXECUTE."	The confirmation dialog box appears when the converted job is not specified. Select "YES" then the conversion is executed. The JOB CONTENT window appears when the conversion is completed. When "CANCEL" is selected, the display goes back to the JOB CONTENT window without executing conversion. <div data-bbox="775 521 1326 931" style="border: 1px solid black; padding: 5px; margin: 10px 0;"> </div> <div data-bbox="655 987 1428 1115" style="border: 1px solid black; padding: 5px; margin-top: 10px;"> <p>NOTE If an alarm occurs during conversion, conversion is suspended.</p> </div>

Calculation by Teaching

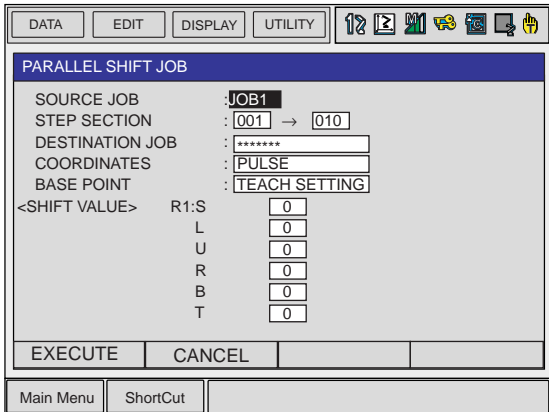
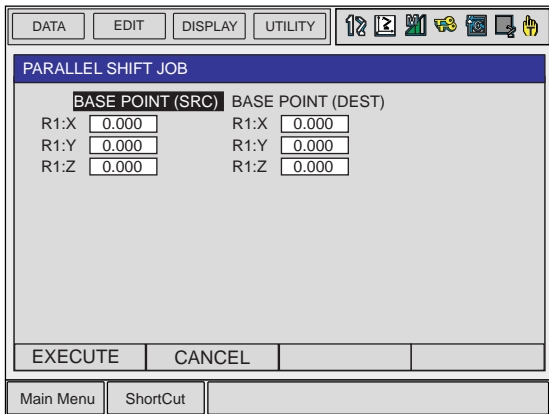
	Operation	Explanation
1	Select {JOB} under the main menu.	
2	Select {JOB}.	The JOB CONTENT window appears.
3	Select {UTILITY} under the pull-down menu.	
4	Select {PARALLEL SHIFT JOB}.	<p>The PARALLEL SHIFT JOB window appears.</p> 
5	Specify the conversion items.	Specify each item.
6	<p>Display the PARALLEL SHIFT JOB window. Select "TEACH SETTING" in the item of "BASE POINT."</p>	<p>The BASE POINT window appears.</p> 
7	Select "BASE POINT(SRC)."	
8	Move the manipulator to the original base point by the axis keys.	

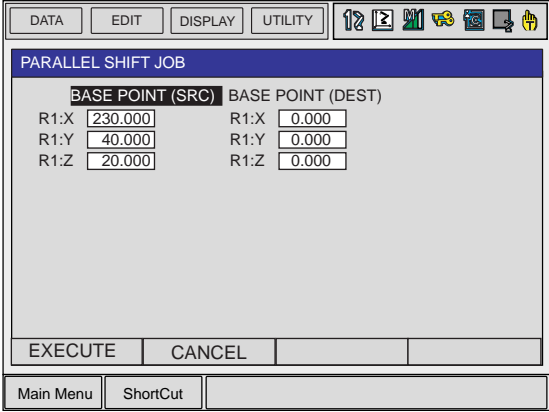
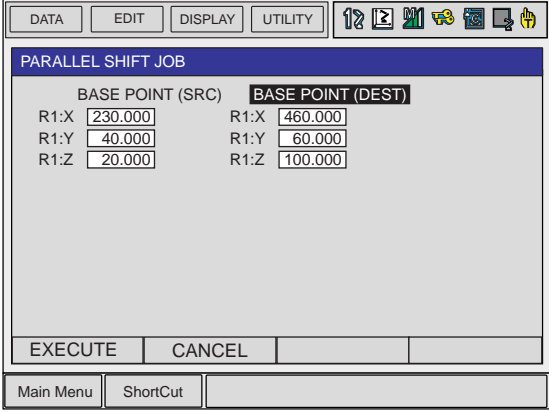
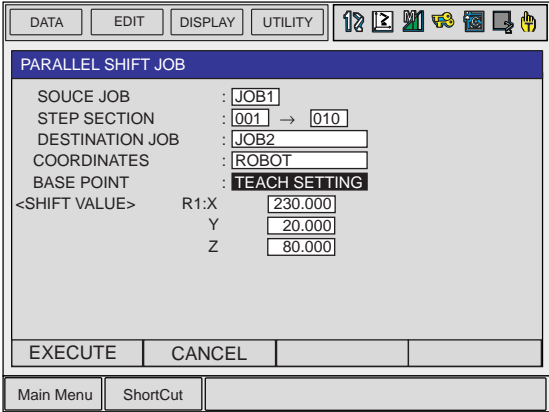
	Operation	Explanation
9	Press [MODIFY] and [ENTER].	<p>The original base point is set.</p> 
10	Select "BASE POINT(DEST)."	
11	Move the manipulator to the converted base point by the axis keys.	
12	Press [MODIFY] and [ENTER].	<p>The conversion base point is set.</p> 
13	Touch "EXECUTE."	<p>The difference is calculated by the two teaching points and set as a shift value.</p> 

6.3 Parallel Shift Job Conversion Function

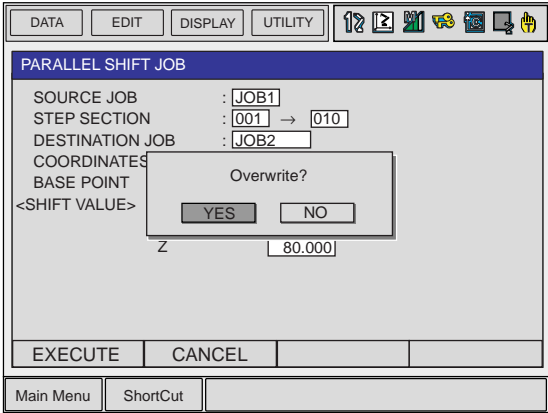
	Operation	Explanation
14	Display the PARALLEL SHIFT JOB window. Select "EXECUTE."	<p>The confirmation dialog box appears when the converted job is not specified. Select "YES" then the conversion is executed. The JOB CONTENT window appears when the conversion is completed.</p> <p>When "CANCEL" is selected, the display goes back to the JOB CONTENT window without executing conversion.</p>  <p>NOTE If an alarm occurs during conversion, conversion is suspended.</p>

6.3.4 Specifying the Shift Value by Position Variables

The shift value can be specified using position variables by parameter settings.

Parameter S2C514: SHIFT VALUE FOR PARALLEL SHIFT JOB CONVERSION

0: Shift value by numeral/teaching (Initial setting)

1: Position variable shift value

■ Window Display

① FILE NO.

Specifies position variables.

② SHIFT JOB NAME

The job which was shown in the JOB CONTENT window is set initially. To change the job, perform the following procedure.

Move the cursor to the conversion job name and press [SELECT]. The JOB LIST window appears. Move the cursor to the desired job and press [SELECT]. The PARALLEL SHIFT JOB window reappears, and the job name which was selected is shown.

③ MODE

Specifies the conversion mode.

SINGLE (INDEPENDENT JOB CONVERSION)

Only the selected job is converted even if the selected job includes jobs called by JUMP or CALL instructions. Related jobs are not converted.

RELATIVE (RELATIVE JOB CONVERSION)

Both the selected job and all the related jobs (the jobs called by JUMP or CALL instructions) are converted.

For details of each conversion mode, refer to " Jobs Targeted for Conversion ".

④ COORDINATES

Selects the conversion coordinates. Move the cursor to the coordinates name and press [SELECT]. The selection dialog box appears. Select the desired coordinates.

When the user coordinates are selected, the input buffer line appears. Input the desired user coordinate number and press [ENTER].

⑤ CONV. METHOD

Specifies the conversion methods of related jobs such as a coordinated job with two manipulators or the system with multiple stations.

COMMON (COMMON SHIFT)

All the manipulators (or all the bases, or all the stations) are converted by the same shift value.

EACH (INDIVIDUAL SHIFT)

Each manipulator (or each base, or each station) is converted separately by different shift values.

For details of each conversion method, refer to " Conversion of Coordinated Jobs ".

■ Jobs Targeted for Conversion

There are two ways to specify the job to be converted as described in the following:

Independent Job Conversion

Only the selected job is converted even if the selected job includes jobs called by JUMP or CALL instructions. Related jobs are not converted.

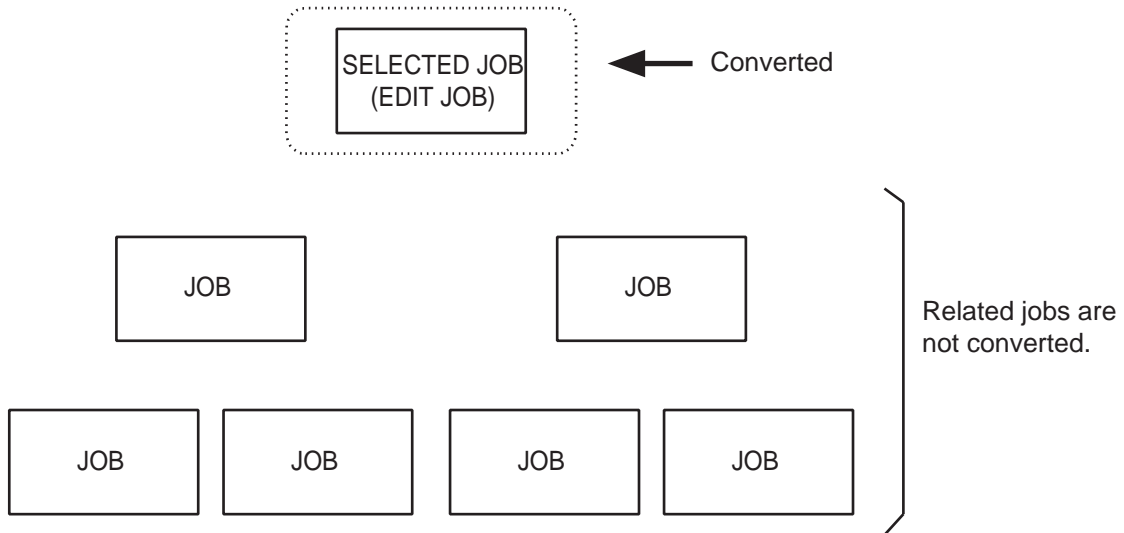

Related Job Conversion

Both the selected job and all the related jobs (the jobs called by JUMP or CALL instructions) are converted.

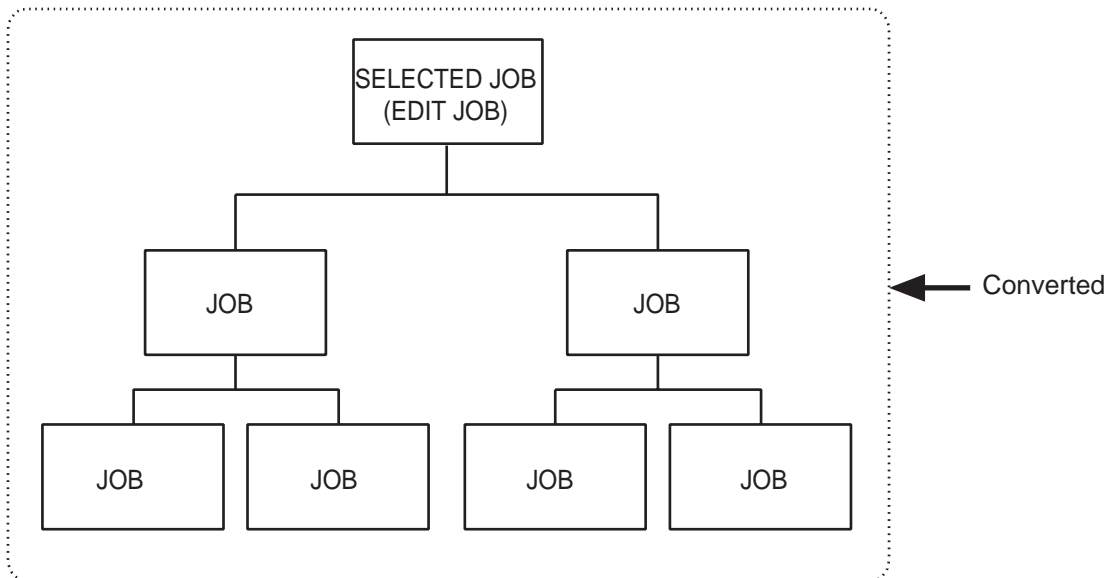

■ Conversion of Coordinated Jobs

There are two ways to convert a related job such as a coordinated job with two manipulators or the system with multiple stations as described in the following:

Common Shift

All the manipulators (or all the bases, or all the stations) are converted by the same shift value.

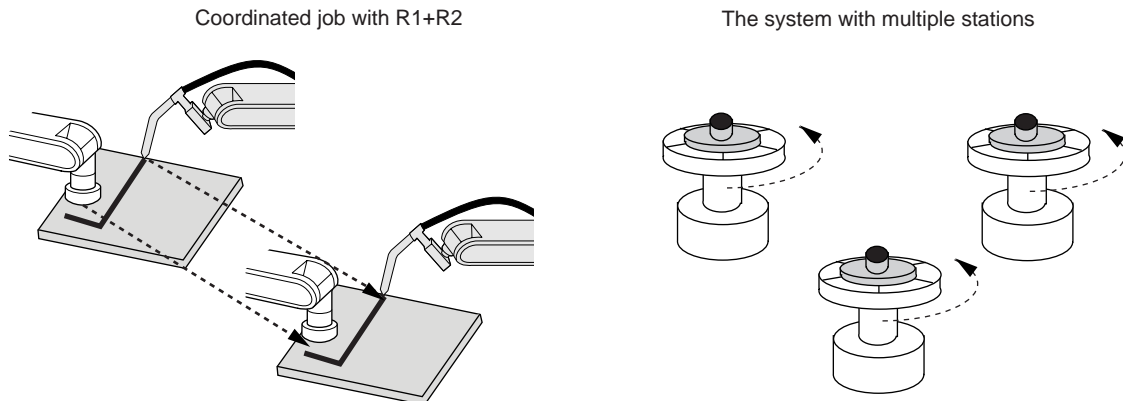

Individual Shift

Each manipulator (or each base, or each station) is converted separately by different shift values.

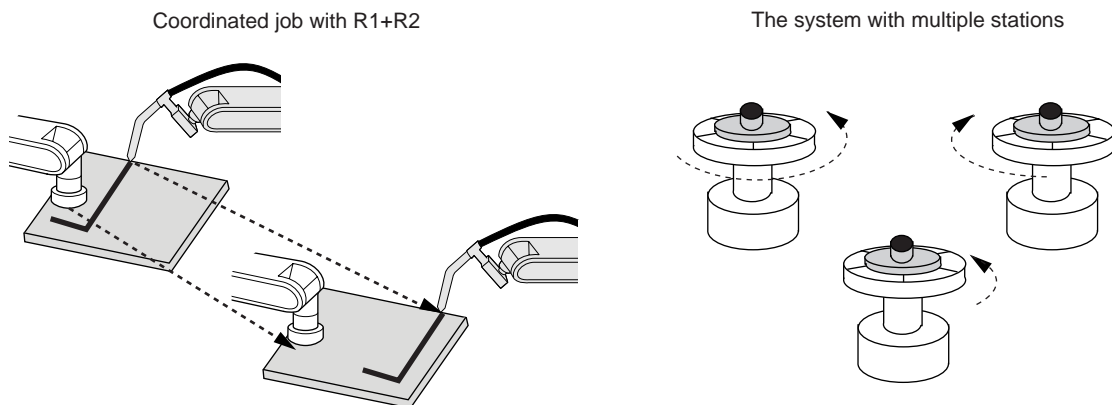

Variables used in an individual shift

NOTE Be sure to use the variables of which numbers are consecutive after the selected number. The variables of which numbers are not consecutive are unable to be selected.

Example 1) When selecting P010 for a coordinated job with R1 + R2:

Use P010 for R1.

Use P011 for R2.

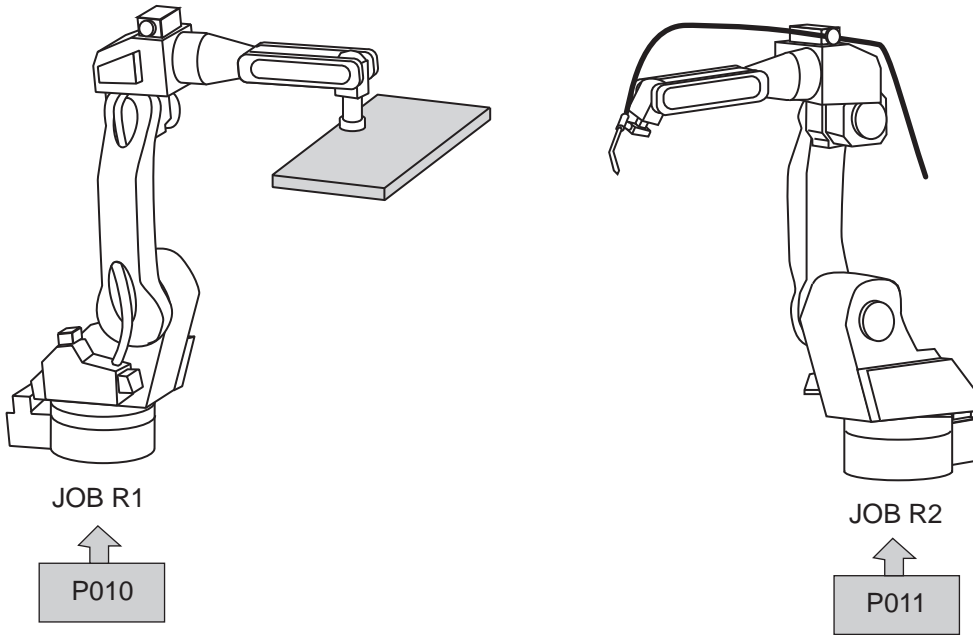

Example 2) When selecting EX005 for multiple jobs with four stations:

Use EX005 for S1.

Use EX006 for S2.

Use EX007 for S3.

Use EX008 for S4.

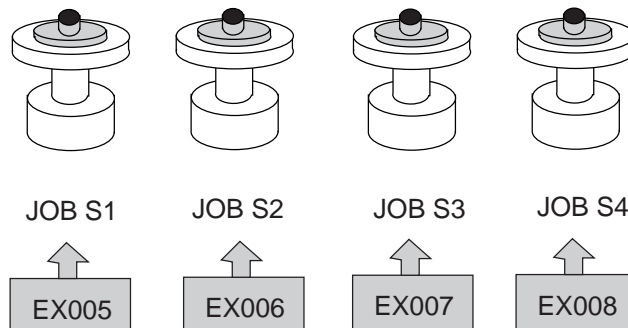

Relation between variables and jobs for conversion in an individual shift

In case of independent job conversion:

- Coordinated job with R1 + R2
Different shift values can be set for each manipulator and base.

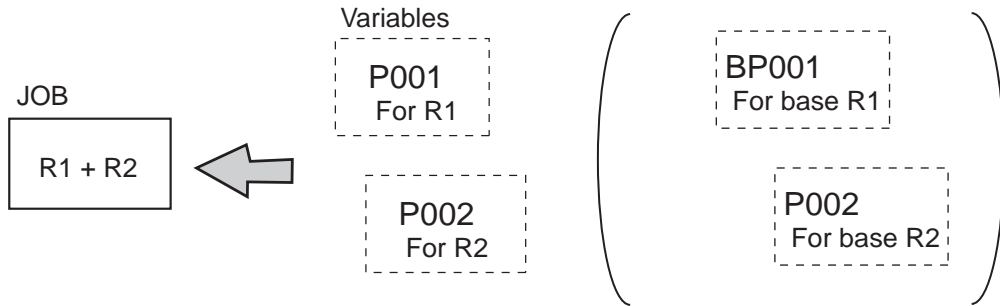

- Job with R₀ (+ S₀)
Use one variable for a job with one manipulator.

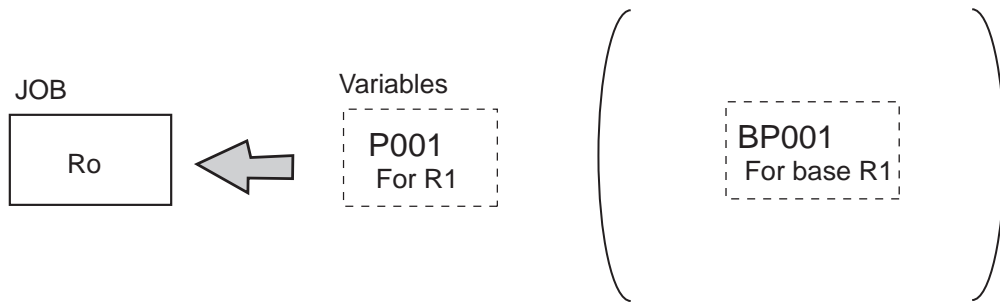

In case of related job conversion:

- Different shift values can be set for each manipulator, base, and station.

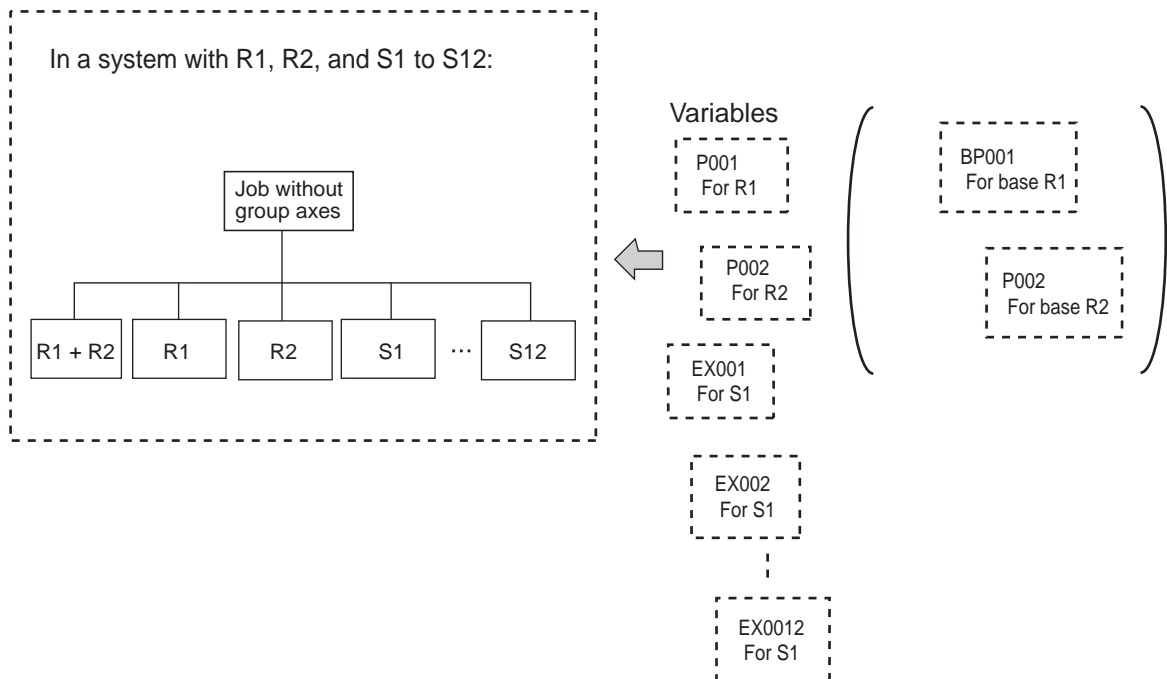

■ Operation Procedure

The following is the operation procedure for parallel shift job conversion using position variables.

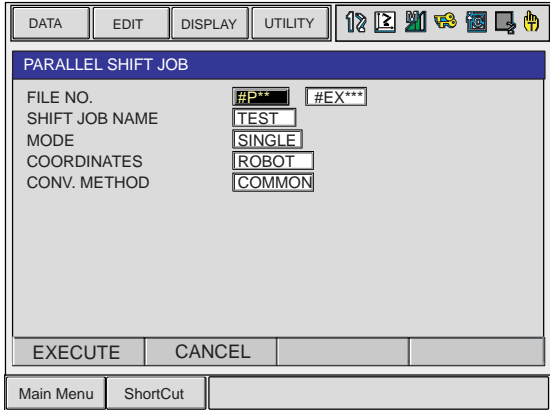
	Operation	Explanation
1	Set the parameter.	Set the parameter S2C514 (SHIFT VALUE FOR PARALLEL SHIFT JOB CONVERSION) to 1 (Position variable shift value.)
2	Set the position variable.	Specify a position variable in advance when setting a shift value by position variables. For the setting of position variables, refer to " 3.9.4 User Variables ".
3	Select {JOB} under the main menu.	
4	Select {JOB}.	The JOB CONTENT window appears.
5	Select {UTILITY} under the pull-down menu.	
6	Select {PARALLEL SHIFT JOB}.	<p>The PARALLEL SHIFT JOB window appears.</p> 
7	Specify the conversion items.	Specify each item.
8	Select "EXECUTE."	<p>Select "EXECUTE" then the parallel shift job conversion is executed. The JOB CONTENT window appears when the conversion is completed.</p> <p>When "CANCEL" is selected, the display goes back to the JOB CONTENT window without executing conversion.</p> <div data-bbox="587 1688 1353 1816" style="border: 1px solid black; padding: 5px;"> <p>NOTE If an alarm occurs during conversion, conversion is suspended.</p> </div>

NOTE Specify the position variable in advance when using the setting value as a shift value.

6.4 PAM Function

6.4.1 Function Overview

The function for position adjustment during playback (PAM: Position Adjustment by Manual) allows position adjustment by simple operations while observing the motion of the manipulator and without stopping the manipulator. Positions can be adjusted in both teach mode and play mode.

The following data can be adjusted by key input at the programming pendant.

- Teaching Point (Position)
- Teaching Point (Posture angle): Valid from NS3.00
- Operation Speed
- Position Level

■ Input Ranges for Adjustment Data

The input ranges for adjustment data are indicated in the following table.

Data	Input Range	
Number of Steps for Adjustment	Up to 10 steps can be adjusted at the same time.	
Position Adjustment Range (X, Y, Z)	Unit: mm, valid to two decimal places, maximum ± 10 mm	
Posture Angle Adjustment Range (Rx, Ry, Rz)	Unit: deg, valid to two decimal places, maximum ± 10 deg	Valid from NS3.00
Speed Adjustment Range (V)	Unit: %, valid to two decimal places, maximum $\pm 50\%$	
PL Adjustment Range	0 to 8	
Adjustment Coordinates	Robot coordinates, base coordinates, tool coordinates, user coordinates (Default coordinates: robot coordinates)	



The input ranges for adjustment data can be changed by the following parameters:

S3C806: Position adjustment range (unit: mm)

S3C807: Speed adjustment range (unit: 0.01%)

S3C808: Adjustment coordinate specification

S3C810: Posture angle adjustment range (unit: 0.01 deg) [Valid from NS3.00]

For details, refer to "8 Parameter Description."



- Base axis and station axis data cannot be adjusted.
- Adjustment when a TCP instruction is executed is performed by adjusting the data of the selected tool.
- When the coordinates for adjustment are user coordinates, an error occurs if teaching has not been performed in the user coordinates.
- If an attempt is made to adjust "PL" when there is no "PL" in the step subject to the adjustment, an error occurs.
- Position variable and reference point steps cannot be adjusted. An error occurs if adjustment is attempted.
- An attempt to adjust the speed at a step that has no speed tag will cause an error.

6.4.2 Operating Methods

■ Setting Adjustment Data

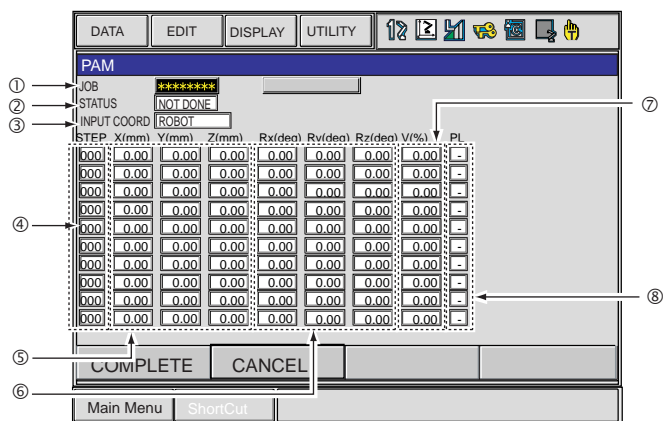
	Operation	Explanation
1	Select {JOB} under the main menu.	
2	Select {JOB}.	The JOB CONTENT window (in the teach mode) or the PLAY-BACK window (in the playback mode) appears.
3	Select {UTILITY} under the pull-down menu.	
4	Select {PAM}.	The PAM window appears. 
5	Set adjustment data.	<p>Set adjustment data.</p> <p>①JOB Set the job name to be adjusted. Line up the cursor and press [SELECT] to display the JOB LIST window. Move the cursor to the desired job and press [SELECT] to set the adjusted job.</p> <p>②STATUS Shows the status of adjustment in the PAM function. “NOT DONE” appears when adjustment is not executed. “DONE” appears when the execution of adjustment is completed.</p> <p>③INPUT COORD Set the desired coordinates. Line up the cursor and press [SELECT] to display the selection dialog box. Move the cursor to the desired coordinate system and press [SELECT] to set the input coordinates.</p>

	Operation	Explanation
5	(cont'd)	<p>④Step Number Set the step number to be adjusted. Line up the cursor and press [SELECT] to display the number input buffer line. Input the step number and press [ENTER] to set the value.</p> <p>⑤XYZ Coordinate Adjustment Set the direction and amount of the X, Y, and Z coordinates. Line up the cursor with the data to be adjusted and press [SELECT] to display the number input buffer line. Input the number data and press [ENTER] to set the adjusted data.</p> <p>⑥Rx, Ry, Rz Coordinate Adjustment Set the direction and amount of the Rx, Ry and Rz posture angles. Line up the cursor with the data to be adjusted and press [SELECT] to display the number input buffer line. Input the number data and press [ENTER] to set the adjusted data.</p> <p>⑦V Coordinate Adjustment Set the speed. Line up the cursor and press [SELECT] to display the number input buffer line. Input the number data and press [ENTER] to set the adjusted data.</p> <p>⑧PL This is displayed when the position level of the job to be adjusted for the step set in ④ is already decided, and the data can be modified. When the position level is not decided, [-] is displayed, and cannot be set. To modify the position level, line up the cursor, press [SELECT], input the number value and press [ENTER].</p>

■ Executing the Adjustment

Executing the Adjustment

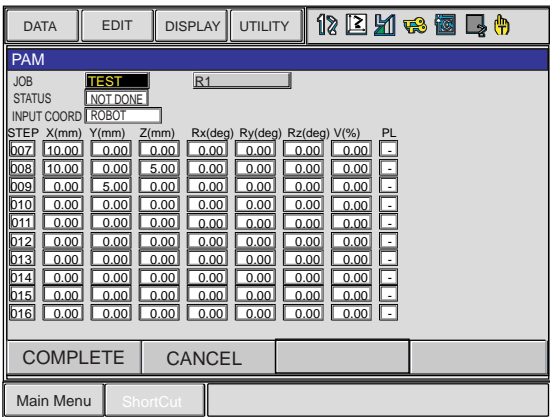
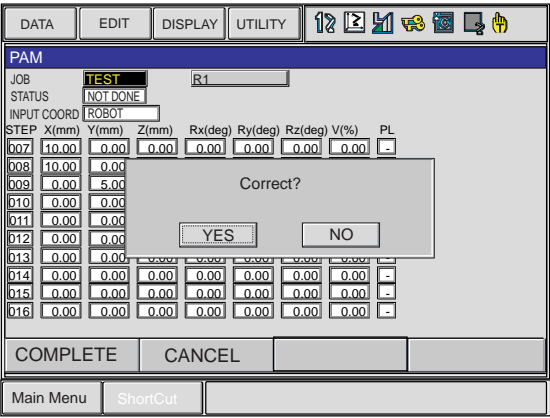
	Operation	Explanation
1	Touch "COMPLETE" on the screen.	<p>The confirmation dialog box appears.</p> 
2	Select "YES."	<p>In the teach mode, the job adjustment can be immediately executed. In the play mode, the job can be adjusted just before execution (move operation). When the job adjustment is completed, the set data shown in the PAM window is cleared. However, if the step's adjusted position exceeds the software limit, an error occurs, and the data in only that step cannot be cleared on the window.</p> 

Cancelling the Execution

In the play mode, during the adjustment wait status, “STOP” is displayed in the PAM window. To cancel the adjustment process, touch “STOP” on the screen. Also, if the following occurs before executing, the process is automatically cancelled.

- If the mode is changed
- If an alarm occurs
- If the power is turned OFF

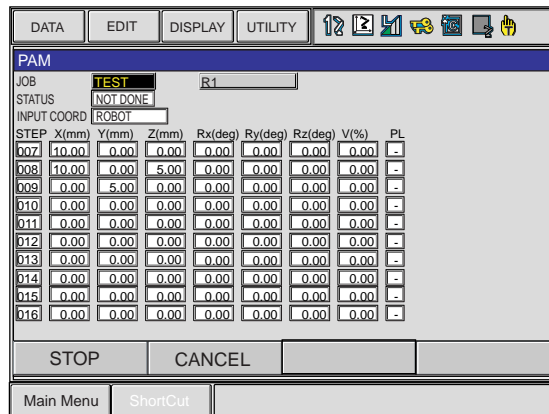

■ Editing Data

Clearing Data

If there is a mistake made when adjusting the data, or if the adjustment of the step becomes unnecessary, the data can be cleared.

	Operation	Explanation
1	Move the cursor to the step of the data to be cleared.	<p>Steps in which data is to be cleared.</p>
2	Select {EDIT} under the menu.	The pull-down menu appears.
3	Select {LINE CLEAR}.	The line data is cleared.

Copying Data

To input the same data as those set previously, perform the following operation.

	Operation	Explanation
1	Move the cursor to the line to be copied.	
2	Select {EDIT} under the menu.	The pull-down menu appears. <div data-bbox="769 524 1315 936" data-label="Image"> <p>The screenshot shows the PAM software interface. At the top, there are tabs for DATA, EDIT, DISPLAY, and UTILITY. The EDIT menu is open, showing three options: LINE CLEAR, LINE COPY (highlighted), and LINE PASTE. Below the menu, there is a table with the following columns: STEP, X(mm), Y(mm), Z(mm), Ax(deg), Ay(deg), Az(deg), V(%), and PL. The table contains data for steps 007 through 016. Step 007 is highlighted. At the bottom of the interface, there are buttons for COMPLETE, CANCEL, and a Main Menu/ShortCut section.</p> </div>
3	Select {LINE COPY} under the pull-down menu.	
4	Move the cursor to the line where the item is to be copied.	
5	Select {EDIT} under the menu.	
6	Select {LINE PASTE}.	The desired data is copied to the line. However, if the line where the data is to be copied does not have a speed value or PL value, it cannot be copied.

Canceling the Adjustment [Valid from NS3.00]

After the position adjustment in the PAM function, the job can be undone to the status before adjustment only during teaching. To undo the job, perform the following operation. However, the job cannot be undone during playback.

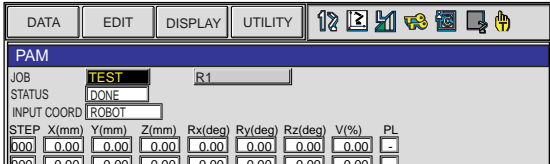
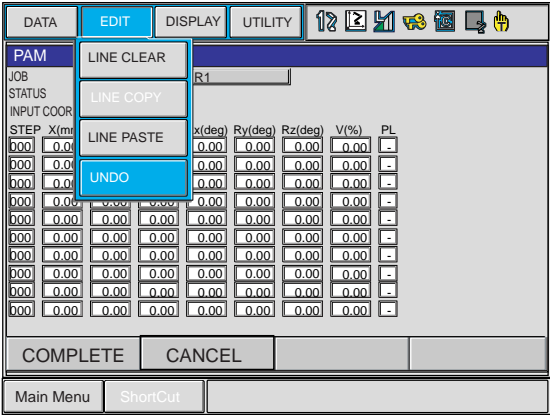
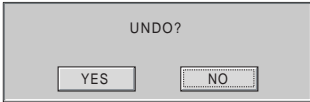
	Operation	Explanation
1	Move the cursor to the line to be copied.	After the position adjustment, the status shows "DONE." 
2	Select {EDIT} under the menu.	The pull-down menu appears. 
3	Select {UNDO} under the pull-down menu.	The confirmation dialog box appears. 
4	Select "YES"	The status turns "NOT DONE" and the job is undone when selecting "YES." The status does not change and the job is not undone when selecting "NO."

6.5 Mirror Shift Function

6.5.1 Function Overview

With the mirror shift function, a job is converted to the job in which the path is symmetrical to that of the original job. This conversion can be performed for the specified coordinate among the X-Y, X-Z, or Y-Z coordinate of the robot coordinates and the user coordinates.

The mirror shift function is classified into the following three: the pulse mirror-shift function, the robot-coordinates mirror-shift function, and the user-coordinates mirror-shift function.

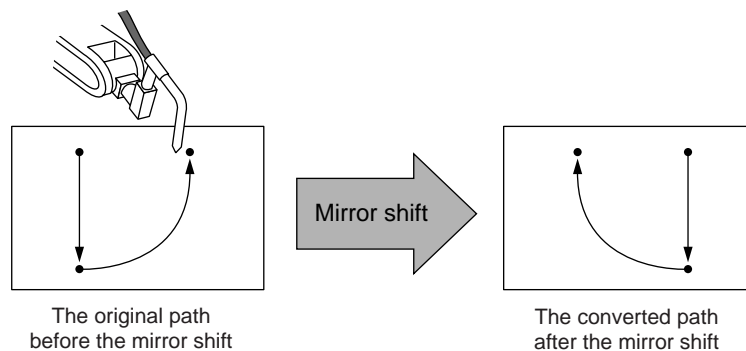

6.5.2 Pulse Mirror-shift Function

With the pulse mirror-shift function, the mirror shift is performed by reversing the sign (+/-) for the axes which are specified with the parameter in advance.

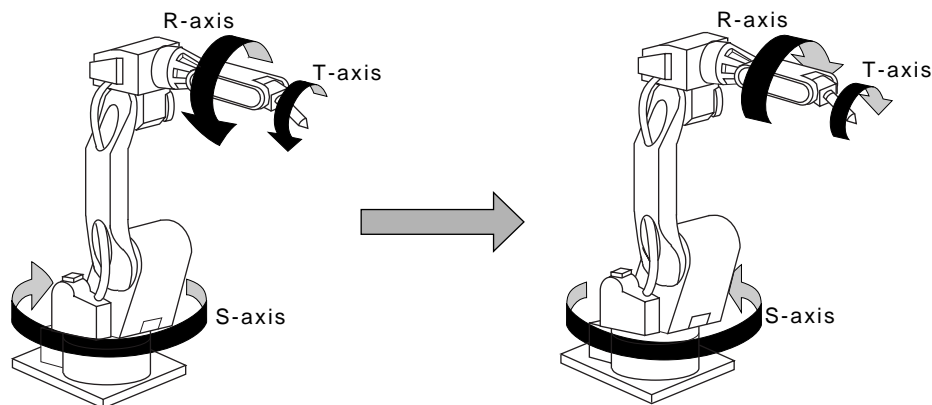

■ Parameter Setting

Using the following parameter, specify the axes for which the sign is to be reversed.

S1CxG065: Mirror Shift Sign Reversing Axis Specification

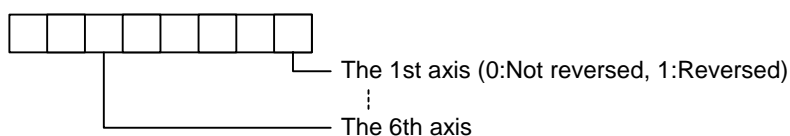

■ Object Job

Jobs without group axes and relative jobs cannot be converted.

■ Group Axes Specification

When specifying the group axes for the converted job in a multiple group axes system, the group axes specified in the original and converted jobs must be the same.

- Robot Axis: Same model
- Base Axis: Same configuration
- Station Axis: Same configuration

■ Position Variables

Position variables are not converted by the mirror shift function.

6.5.3 Robot-coordinates Mirror-shift Function

With the robot-coordinates mirror-shift function, the mirror shift is performed on the X-Z coordinate of the robot coordinates.

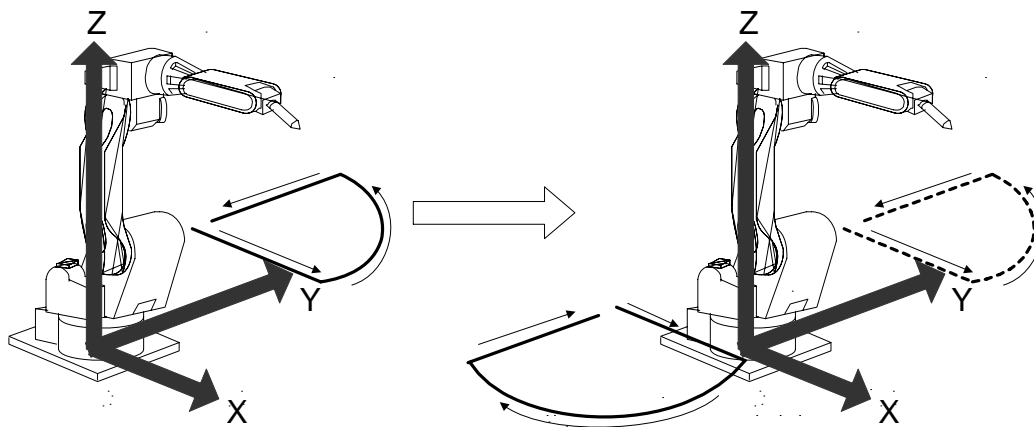

■ Object Job

Jobs without group axes cannot be converted.

■ Group Axes Specification

When specifying the group axes for the converted job in a multiple group axes system, the group axes specified in the original and converted jobs must be the same.

- Robot Axis: Same model
- Base Axis: Same configuration
- Station Axis: Same configuration

■ Position Variables

Position variables are not converted by the mirror shift function.



- Mirror shift conversion for the base axis is not performed with the robot-coordinates mirror shift function.
- With the robot-coordinates mirror shift function, mirror shift conversion for the station axis is performed by reversing the sign for the axes specified with the parameter S1CxG065 "Mirror Shift Sign Reversing Axis Specification."

6.5.4 User-coordinates Mirror-shift Function

With the user-coordinates mirror-shift function, the mirror shift is performed on the X-Z, X-Y, or Y-Z coordinate of the specified user coordinates.

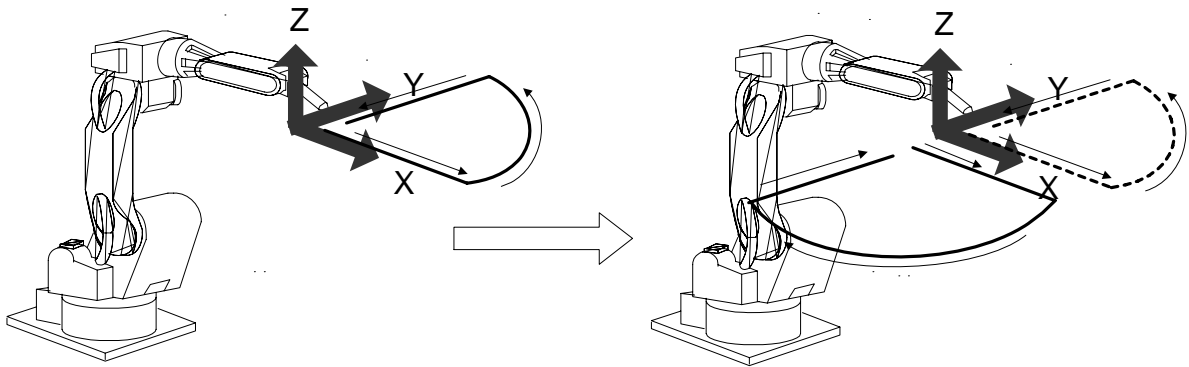

■ Object Job

Jobs without group axes cannot be converted.

■ Group Axes Specification

When specifying the group axes for the converted job in a multiple group axes system, the group axes specified in the original and converted jobs must be the same.

- Robot Axis: Same model
- Base Axis: Same configuration
- Station Axis: Same configuration

■ Position Variables

Position variables are not converted by the mirror shift function.



With the user-coordinates mirror shift function, mirror shift conversion for the station axis is performed by reversing the sign for the axes specified with the parameter S1CxG065 "Mirror Shift Sign Reversing Axis Specification."

6.5.5 Notes on the Mirror Shift Function

For manipulators, such as a polishing wrist, whose center of S-axis rotation and T-axis rotation are offset in the X-coordinate direction, the mirror shift cannot correctly be performed by the pulse mirror-shift function. Be sure to use the robot-coordinates mirror-shift function or use the user-coordinates mirror-shift function with the user coordinates specified on the center of the T-axis rotation.

- Using the Robot-coordinates Mirror-shift Function

When the robot-coordinates mirror-shift function is performed, the mirror shift is performed on the X-Z coordinate of the robot coordinates. The path of the converted job is as follows:

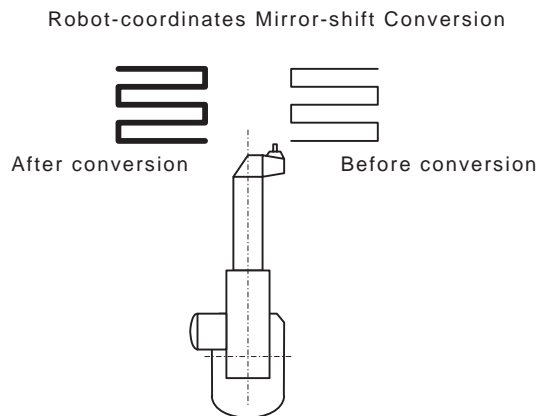

- Using the User-coordinates Mirror-shift Function

To use the user-coordinates mirror-shift function, specify the user coordinates on the center of T-axis rotation in advance.

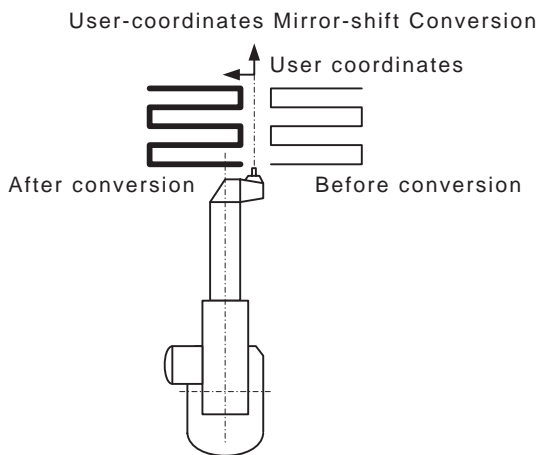

6.5.6 Operation Procedures

■ Calling Up the JOB CONTENT Window

Call up the JOB CONTENT window of the job to be converted as follows:

For Current Job

	Operation	Explanation
1	Select {JOB} under the main menu.	
2	Select {JOB}.	

For Another Job

	Operation	Explanation
1	Select {JOB} under the main menu.	
2	Select {SELECT JOB}.	The JOB LIST window appears.
3	Select desired job.	

■ Mirror Shift Conversion

	Operation	Explanation
1	Display the JOB CONTENT window.	
2	Select {UTILITY} under the pull-down menu.	The MIRROR SHIFT window appears.
3	Select {MIRROR SHIFT}.	The MIRROR SHIFT window appears.

■ Explanation of the Mirror Shift Window

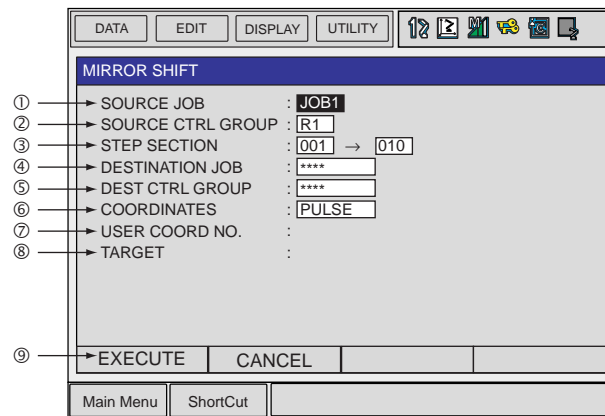

① SOURCE JOB

Selects the conversion source job.

To select another job to be converted, move the cursor to the name and press [SELECT] to call up the list of jobs. Select the desired job and press [SELECT].

② SOURCE CTRL GROUP

Displays the control group of the conversion source job.

③ STEP SELECTION

Specifies the steps to be converted. From the first step to the last step of the selected job are specified as initial value.

④ DESTINATION JOB

Specifies the converted job name. To enter the name, move the cursor to the name and press [SELECT]. The name of the conversion source job is displayed in the input line as initial value. When "****" is displayed, the name for the converted job is to be the same as that of the conversion source job.

⑤ DEST CTRL GROUP

Selects the control group for the converted job. When the destination job name is entered, the same control group as the conversion source job is automatically set. To change it, move the cursor to the control group and press [SELECT] to call up the selection dialog box.

⑥ COORDINATES

Specifies the coordinates used for conversion.

"PULSE": Executes the pulse mirror-shift conversion.

"ROBOT": Executes the mirror-shift conversion on the basis of the cartesian coordinates.

"USER": Executes the mirror-shift conversion on the basis of the specified user coordinates.

⑦ USER COORD NO.

Specifies the user coordinates number when "USER" is selected in ⑥.

This item cannot be set when "PULSE" or "ROBOT" is selected in ⑥.

⑧ TARGET

Specifies the coordinate where conversion is to be done when "ROBOT" or "USER" is selected in ⑥. "XY," "XZ," or "YZ" can be selected. Always specify "XZ" for "ROBOT."

⑨ EXECUTE

Mirror shift conversion is executed when pressing "EXECUTE" or [ENTER]. A job is created with the name of conversion source job when a job after conversion is not entered.

7 External Memory Devices

7.1 Memory Devices

The following memory devices can be used in the NX100 to save and load data such as jobs and parameters.

Device	Function	Media (destination of saved/ loaded data)	Optional function requirement
Compact Flash	Standard	Compact Flash (CF card)	No requirement. Programming pendant is equipped with a slot.
FC1	Option ^{*1}	2DD floppy disk, personal computer (FC1 emulator)	"FC1" or personal computer with "FC1 emulator"
FC2	Option ^{*1}	2DD floppy disk, 2HD floppy disk	"FC2"
PC	Option ^{*1}	Personal computer (MOTOCOM32 host)	<ul style="list-style-type: none"> • Via RS-232C: "Data transmission function" and "MOTOCOM32" • Via Ethernet: "Ethernet function" plus above two requirements
FTP	Option ^{*1}	FTP server such as personal computer	"Data transmission function", "MOTOCOM32", and "FTP function"

^{*1} For the operation, refer to instruction manuals for each optional function.

7.1.1 Compact Flash (CF Cards)

The programming pendant is equipped with CF card slot. Use the FAT16 or FAT32 formatted Compact Flash.

■ Recommended Compact Flash Cards

Recommended products used for external memory of NX100 are listed below. Model numbers are subject to be updated due to termination of product and new addition. Contact Yaskawa representative when necessary.

<Currently Recommended Compact Flash Cards>

No.	Manufacturer	Model	Remarks
1	Hagiwara Sys-Com	MCF10P-128MS (A00A II -YE	(128MB)
2	Hagiwara Sys-Com	MCF10P-256MS-YE2	(256MB)
3	Hagiwara Sys-Com	MCF10P-512MS	(512MB)
4	Hagiwara Sys-Com	MCF10P-A01GS	(1GB)
5	Hagiwara Sys-Com	MCF10P-A02GS	(2GB)

<Previously Recommended Compact Flash Cards>

No.	Manufacturer	Model	Remarks
1	Hagiwara Sys-Com	CFI-128MDG	(128MB)
2	Hagiwara Sys-Com	CFI-256MDG	(256MB)
3	Hagiwara Sys-Com	CFC-064MBA (HOOAA)	(64MB)
4	Hagiwara Sys-Com	CFI-064MBA (HOOAA)	(64MB)
5	SanDisk	SDCFBI-64-EXPP-80	(64MB)

*512 MB (or more) CF cards in the same series can be used as external memory devices. However, FAT32 formatted CF cards such as high-capacity CF cards cannot be used for upgrading Pendant OS version.

■ Notes on handling Compact Flash

- Do not drop or bend exerting any shock or strong force to the Compact Flash.
- Keep away from water, oil, organic solvent, dust, and dirt.
- Do not use or keep the Compact Flash in places where strong static electricity or electronic noise may occur.
- To protect the data, back up the data regularly on other media. Damages or loss of data due to operation errors or accidents can be minimized.

*Compact Flash has a limited life span.

The life span differs depending on products or status of use. However, normal use of Compact Flash as an external memory device for the NX100 does not adversely affect the Compact Flash. For details, refer to instruction manuals for each medium.

NOTE

Removing the CF or disconnecting the control power supply while writing data to the CF/ reading data from the CF may cause data corruption in the CF.

Please DO NOT remove the CF or disconnect the control power supply while

- the remaining bytes indication is switching to the file list window after the data of the external memory device is saved, loaded, or verified, and the hourglass icon disappears.
- the screen is switching to the file list window after the data of the external memory device is deleted.
- the folder list is being updated after a folder is created to or deleted from a folder of the external memory.
- the message "Under running auto backup" is being displayed.
- CMOS.BIN is being saved with the message "Saving system data. Don't turn the power off" displayed.
- CMOS.BIN is being loaded with the message "Loading system data. Don't turn the power off" displayed.

■ Inserting a Compact Flash

When inserting a Compact Flash, take note of insertion direction. With the notch and clip of the Compact Flash downward, insert the Compact Flash slowly into the slot of the programming pendant of which display faces up.

Forcible insertion may result in damage to the Compact Flash or CF card slot. After inserting the card, be sure to close the cover of the slot before starting operation.

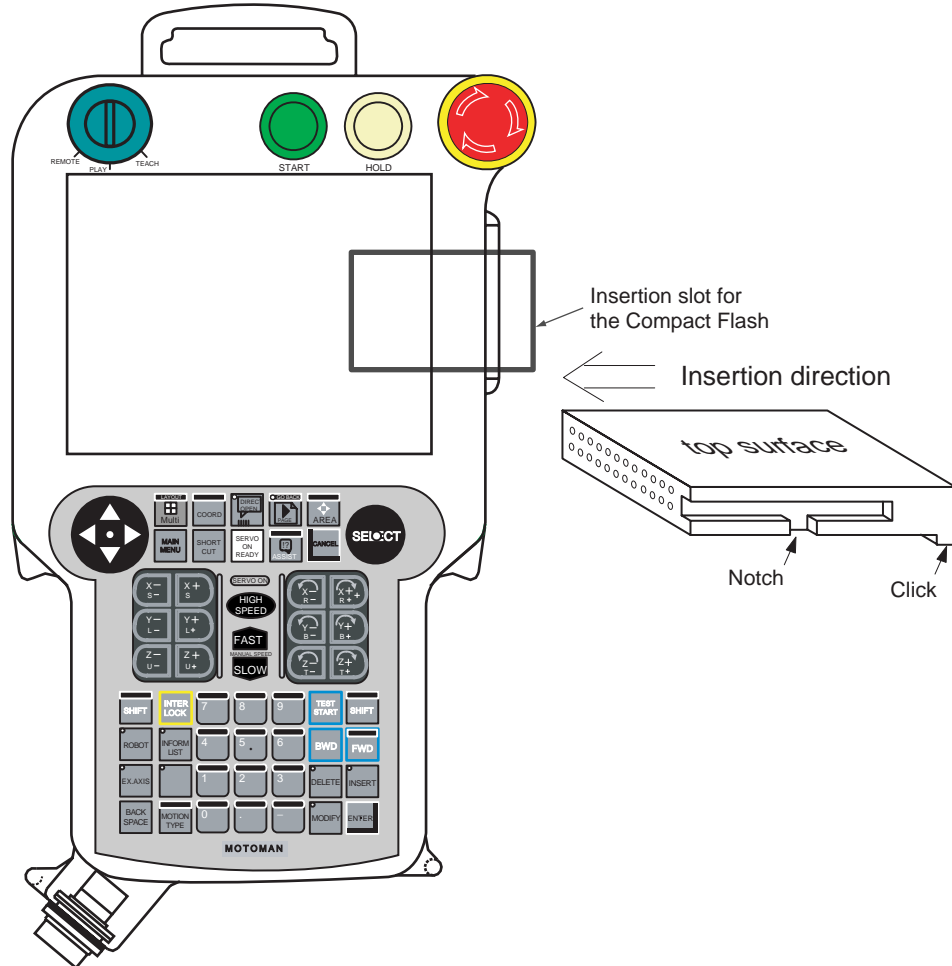

Installing the Compact Flash

7.2 Handling Data

7.2.1 Normal Mode Data Classification

For the NX100, data that can be saved in the normal mode are classified into eight categories.

- ① JOB
- ② FILE/GENERAL DATA
- ③ BATCH USER MEMORY*¹
- ④ PARAMETER*²
- ⑤ SYSTEM DATA
- ⑥ I/O DATA
- ⑦ BATCH CMOS*³
- ⑧ ALL CMOS AREA*⁴

Data saved on the external memory device can be loaded again into the NX100.

Each data in the eight categories varies depending on applications or options.

When the device is set to "PC" and "FTP", data cannot be handled other than "① JOB" and "② FILE/GENERAL DATA."

- *¹ "③ BATCH USER MEMORY" includes "① JOB" and "② FILE/GENERAL DATA."
- *² "PARAMETER BATCH" includes all "④ PARAMETER."
- *³ "⑦ BATCH CMOS" includes "③ BATCH USER MEMORY", "④ PARAMETER", "⑤ SYSTEM DATA", and "⑥ I/O DATA."
- *⁴ "ALL CMOS AREA" data cannot be loaded in edit mode and management mode.



PARAMETER, I/O DATA, SYSTEM DATA, PARAMETER BATCH, BATCH CMOS, and ALL CMOS AREA are used for backup.

If those data are loaded by other controllers, unintended data overwriting, unexpected operation, or abnormal system startup may occur.

Do not load those backup data into other controllers.

If two controllers are loaded with the same job, paths of the two manipulators are different due to the home positions or mechanical error of the component parts.

Be sure to check the operation instruction before operation.

7.2 Handling Data

Data classification		File Name (Saved Data)	Save		Load	
			EDIT	MAN	EDIT	MAN
⑧ ALL CMOS AREA		ALCMSxx.HEX	○	○	X	X
⑦ BATCH CMOS		CMOSxx.HEX	○	○	X	○
③ BATCH USER MEMORY		JOBxx.HEX	○	○	○	○
① JOB	Single job	JOBNAME.JBI	○	○	○	○
	Related job (Job+Condition)	JOBNAME.JBR	○	○	○	○
② FILE/ GENERAL DATA	Tool data	TOOL.CND	○	○	○	○
	Weaving data	WEAV.CND	○	○	○	○
	User coordinate data	UFRAME.CND	○	○	○	○
	Variable data	VAR.DAT	○	○	○	○
	Arc start condition data	ARCSRT.CND	○	○	○	○
	Arc end condition data	ARCEND.CND	○	○	○	○
	Welding condition auxiliary data	ARCSUP.DAT	○	○	○	○
	Power Source characteristic data	WELDER.DAT	○	○	○	○
	Power Source characteristic definition data	WELDUDEF.DAT	○	○	○	○
	Shock detection level data	SHOCKLVL.CND	○	○	○	○
	Motor gun pressure power data	SPRESS.CND	○	○	○	○
	Motor gun dry spot pressure data	SPRESSCL.CND	○	○	○	○
	Spot gun characteristic data	SGUN.DAT	○	○	○	○
	Spot gun condition auxiliary data	SGUNSUP.DAT	○	○	○	○
	Spot welding Power Source characteristic data	SWELDER.DAT	○	○	○	○
Spot I/O allocation data	SPOTIO.DAT	○	○	○	○	
Spot welding condition data	SPOTWELD.DAT	○	○	○	○	
Short/Full open position data	STROKE.DAT	○	○	○	○	

Data classification		File Name (Saved Data)	Save		Load			
			EDIT	MAN	EDIT	MAN		
⑧	⑦	④ PARAMETER BATCH	ALL.PRM	○	○	X	○	
		④ PARAME- TER	Robot matching parameter	RC.PRM	○	○	X	○
			System definition parameter	SD.PRM	○	○	X	○
			Coordinate home position parameter	RO.PRM	○	○	X	○
			System matching parameter	SC.PRM	○	○	X	○
			CIO parameter	CIO.PRM	○	○	X	○
			Function definition parameter	FD.PRM	○	○	X	○
			Application parameter	AP.PRM	○	○	X	○
			Transmission(general) parameter	RS.PRM	○	○	X	○
			Sensor parameter	SE.PRM	○	○	X	○
			Servo parameter	SV.PRM	○	○	X	○
			Servomotor parameter	SVM.PRM	○	○	X	○
			Operation control parameter	AMC.PRM	○	○	X	○
			Servo power block parameter	SVP.PRM	○	○	X	○
			Motion function parameter	MF.PRM	○	○	X	○
			SERVOPACK parameter	SVS.PRM	○	○	X	○
			Converter parameter	SVC.PRM	○	○	X	○
		⑤ I/O DATA	Concurrent I/O program	CIOPRG.LST	○	○	X	○
			I/O name data	IONAME.DAT	○	○	X	○
			Pseudo input signals	PSEUDOIN.DAT	○	○	X	○
		⑥ SYSTEM DATA	User word registration	UWORD.DAT	○	○	X	○
			SV monitor signals	SVMON.DAT	○	○	X	○
			Variable name	VARNAME.DAT	○	○	X	○
			Second home position	HOME2.DAT	○	○	X	○
			Alarm history data	ALMHIST.DAT	○	○	X	X
			Home position calibrating data	ABSO.DAT	○	○	X	○
			System information	SYSTEM.SYS	○	○	X	X
			Work home position data	OPEORG.DAT	○	○	X	○
			I/O message history data	IOMSGHST.DAT	○	○	X	X
			Function key allocation data	KEYALLOC.DAT	○	○	X	○

EDIT : Edit Mode, MAN: Management Mode

○ : Can be done, X : Cannot be done

7.2.2 Collective Backup

For the NX100, four types of collective backup are available: CMOS.BIN, CMOSBK.BIN, ALCMSxx.HEX, and CMOSxx.HEX.

■ CMOS.BIN

For the normal backup, use this data.

Save: Perform in the maintenance mode (the editing mode or higher.)

Load: Perform in the maintenance mode (the management mode.)

As for the load/save procedures, refer to "NX100 INSTRUCTIONS (RE-CTO-A211)".

Target Area: All areas of the internally-stored data. (Note that the monitoring time is not loaded.)

■ CMOSBK.BIN

This data is used in the automatic backup function.

Save: In the normal mode, saves with the preset conditions.

Load: Perform for the system restoration in the maintenance mode (the management mode.)

For details, refer to "NX100 INSTRUCTIONS (RE-CTO-A211)".

Target Area: All areas of the internally-stored data. (Note that the monitoring time is not loaded.)

■ CMOSxx.HEX

This data is loaded/saved in the FD/CF menu of the normal mode.

Save: Perform in the normal mode (the editing mode or higher.)

Load: Perform in the normal mode (the management mode.)

For details, refer to the following pages.

Target Area: The collected data including "Job File", "Data File", "Parameter File", "System Data", and "I/O Data" which can be individually loaded/saved in the FD/CF menu. Because the setting information of robot etc. are not included in the collected data, the system cannot be completely restored.

■ ALCMSxx.HEX

This data is for the manufacturer only. Users can save but cannot load this data.

In order to save the batch data, the following free space per file is needed in the Compact Flash card.

JZNC-NIF01-1: (The number of stored file + 1) x 7.5 MByte

JZNC-NIF01-2: (The number of stored file + 1) x 11.0 MByte

Note that the free space for one working file is needed in addition to the abovementioned space when using the automatic backup function.

Besides, it is recommended to store the backup data in two or more Compact Flash cards to minimize problems if the Compact Flash card is damaged.

7.2.3 File Existence

The following data categories show whether the same file name as a file that is going to be saved is in the external memory device or not.

- **JOB**

No mark appears when the selected folder has the file of the same name.
The asterisk (*) appears when the folder does not have the same name file.

- **FILE/GENERAL DATA, PARAMETER, SYSTEM DATA, I/O DATA**

Black circle (●) appears when the selected folder has the file of the same name.
White circle (○) appears when the folder does not have the same name file.



Whether the job after editing is saved or not can be judged by checking “TO SAVE TO FD” in the JOB HEADER window. However, the status of “TO SAVE TO FD” does not change after saving “③ BATCH USER MEMORY” and “⑦ BATCH CMOS”

FLOPPY DISK/Compact Flash CF (SAVE) SINGLE NO. 33 FOLDER			
AA35	AA36	AA37	
AA4	AA5	AA6	
AA7	AA8	AA9	
N	N1	TEST	
TEST2	TEST3	TEST3A	
TEST3A-!	TEST3A-'	TEST3A-(
TEST3A-)	TEST3A--	TEST3A-1	
TEST3A-2	TEST3A-3	TEST3A-4	*
TEST3A-5 *	TEST3A-6 *	TEST3A-7 *	
TEST3A-8 *	TEST3A-9 *	TEST3A-A *	
TEST3A-B *	TEST3A-C *	TEST3A-D *	

Example of JOB

FLOPPY DISK/Compact Flash CF (SAVE) FOLDER		
●	TOOL DATA	TOOL .CND
○	WEAVING DATA	WEAV .CND
●	USER COORDINATE DATA	UFRAME .CND
●	VARIABLE DATA	VAR .DAT
○	ARC START COND DATA	ARCSRT .CND
○	ARC END COND DATA	ARCEND .CND
○	ARC AUXILIARY COND DATA	ARCSUP .DAT
○	POWER SOURCE COND DATA	WELDER .DAT
○	USER DEF PWR SRC COND DATA	WELDUDEF.DAT
○	INTERRUPT JOB	INTJOB .DAT

Example of FILE/GENERAL DATA

■ Saving by Overwriting

“③ BATCH USER MEMORY”, “⑦ BATCH CMOS”, and “⑧ ALL CMOS AREA” can be overwritten.

As for “① JOB”, “② FILE/GENERAL DATA”, “④ PARAMETER”, “⑤ SYSTEM DATA”, and “⑥ I/O DATA”, those data cannot be overwritten. Delete the target file in the device before the saving operation. If Compact Flash is used as the device, the file does not need to be deleted because another folder can be created to save the data.

7.3 Operation Flow

The following description is the operation flow for external memory devices.

- **SELECT DEVICE**

Select {FD/PC CARD} --> {DEVICE}, and the destination device for saving.
 The device selected is valid after turning the power supply ON again.
 *1 Sub menu {FORMAT} appears when selecting FC1 or FC2.

- **SELECT FOLDER**

Select {FD/PC CARD} --> {DEVICE}, and the destination folder for saving.
 The folder selected is invalid after turning the power supply ON again.
 *2 {FOLDER} appears when using the Compact Flash as a device.
 *3 The settings of {CREATE NEW FOLDER}, {DELETE FOLDER}, and {ROOT FOLDER} can be set.

- **SELECT SUB MENU**

Select an operation to be performed from {LOAD}, {SAVE}, {VERIFY}, and {DELETE}.

- **SELECT DATA CATEGORY**

Select the target data category.

- **SELECT DATA**

Select the target data.
 "ⓐ BATCH USER MEMORY", "ⓑ BATCH CMOS", and "Ⓒ ALL CMOS AREA" do not require this operation.
 4 Individual selection, batch selection, marker () selection, and canceling selection can be performed.

- **EXECUTE**

Select [ENTER] or {EXECUTE}.

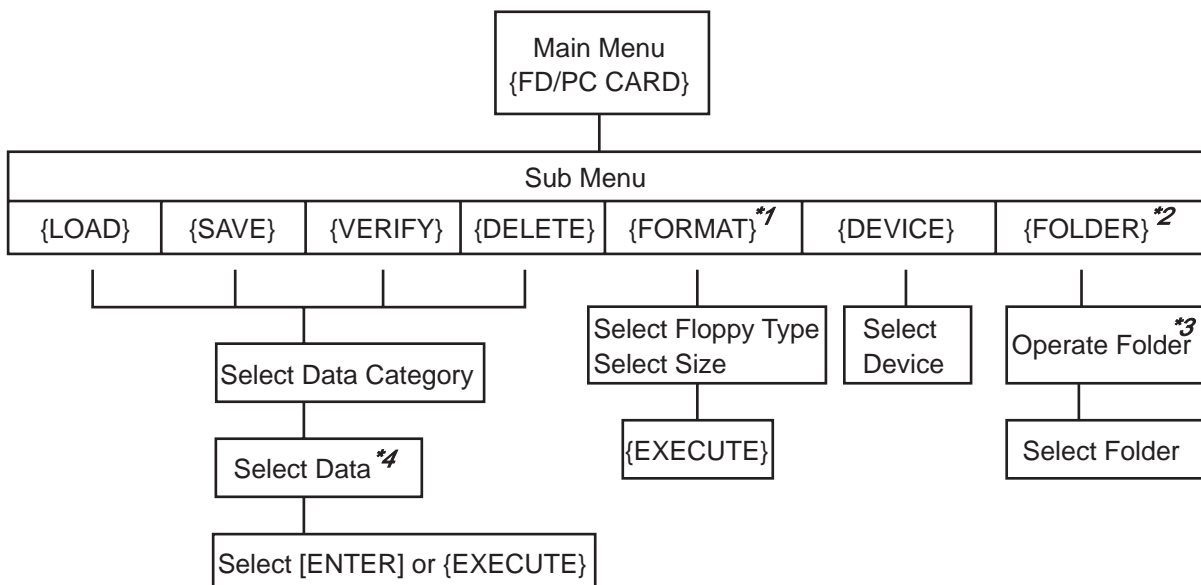

■ Operating a Folder

Folders can be used in order to classify and sort out the data such as jobs and condition files when using the Compact Flash. The folders can be created in hierarchical structure positioning a root folder at the top.

Restrictions

Folder name: Up to 8 one-byte characters + 3 characters for extension

*Long folder names cannot be used such as the name that exceeds the restricted number of characters mentioned above as created in PC, etc.

Maximum path length: 64 one-byte characters

**"ERROR 3360: INVALID FOLDER" appears when selecting the folder of which name exceeds the maximum path length.

Selecting a Folder

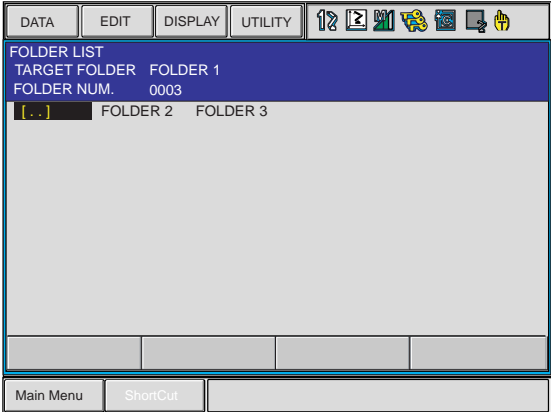
	Operation	Explanation
1	Select {FD/PC CARD} under the main menu.	
2	Select {FOLDER}.	The FOLDER LIST window appears.
3	Move the cursor to a folder and press [SELECT].	A folder can be selected.
4	To move the hierarchy from a child folder to a parent folder, move the cursor to [..] and press [SELECT].	

Creating a Folder

	Operation	Explanation
1	Change the security to management mode. Select {FD/PC CARD} under the main menu.	
2	Select {FOLDER}.	The FOLDER LIST window appears.
3	Move the cursor to a folder and press [SELECT].	Select the higher-level folder where a new folder to be created should be contained. When creating a folder in top-level, this step is unnecessary.
4	Select {DATA} --> {CREATE NEW FOLDER} under the pull-down menu. Input folder name using the keyboard on the screen and press [ENTER].	A folder is created.

Deleting a Folder

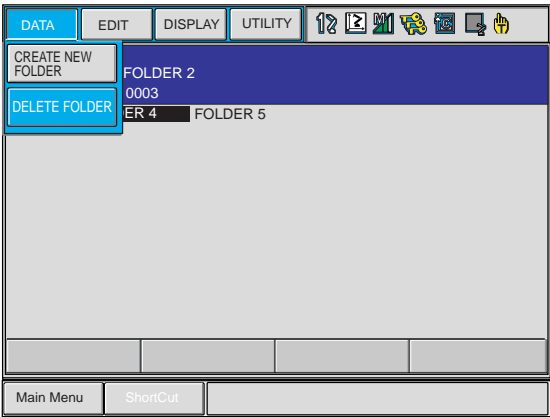
	Operation	Explanation
1	Change the security to management mode. Select {FD/PC CARD} under the main menu.	
2	Select {FOLDER}.	The FOLDER LIST window appears.
3	Move the cursor to a folder and press [SELECT].	Select the higher-level folder where a folder to be deleted is contained. When deleting a folder in top-level, this step is unnecessary.
4	Delete the files and subfolders beforehand inside the folder that is to be deleted.	A folder cannot be deleted if the folder contains files or subfolders inside.
5	Move the cursor to the folder to be deleted. Select {DATA} --> {DELETE FOLDER} under the pull-down menu.	 <p>The screenshot shows a graphical user interface for a folder management system. At the top, there are menu tabs: DATA, EDIT, DISPLAY, and UTILITY. Below these are several icons. A pull-down menu is open, showing two options: 'CREATE NEW FOLDER' and 'DELETE FOLDER', with 'DELETE FOLDER' highlighted. The main area of the window displays a list of folders: 'FOLDER 2', '0003', 'ER 4', and 'FOLDER 5'. At the bottom of the window, there are buttons for 'Main Menu' and 'ShortCut'.</p>

Initial Folder Setting

The folder that is contained in a deep hierarchy can be selected in a shortened operation. When selecting {LOAD}, {SAVE}, {VERIFY}, or {DELETE} from the sub menu of {FD/PC CARD}, the folder that has been set as an initial folder becomes a current folder.

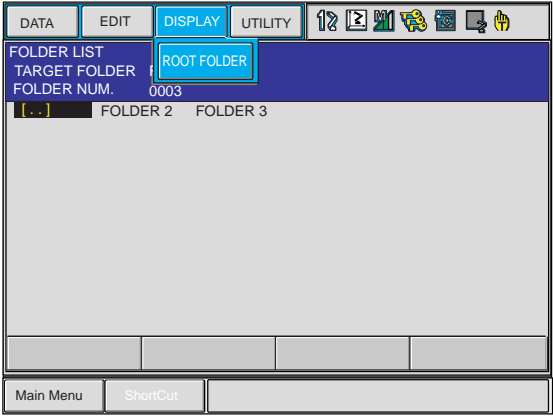
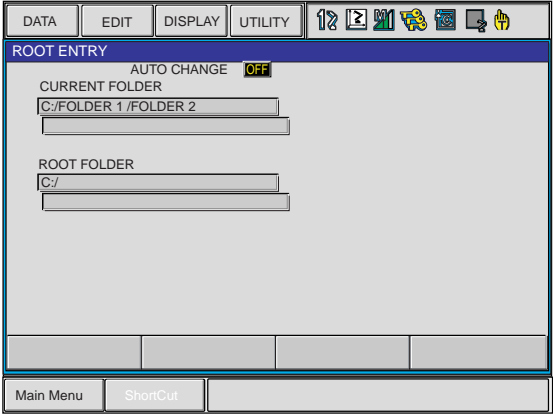
	Operation	Explanation
1	Change the security to management mode. Select {FD/PC CARD} under the main menu.	
2	Select {FOLDER}.	The FOLDER LIST window appears.
3	Move the cursor to a folder and press [SELECT].	Select a folder that is to be set as a root folder.
4	Select {DISPLAY} --> {ROOT FOLDER} under the pull-down menu.	<p>The INITIAL FOLDER SETTING window appears.</p>  <p>A folder currently selected appears in "CURRENT FOLDER" and the initial folder appears in "ROOT FOLDER."</p> 

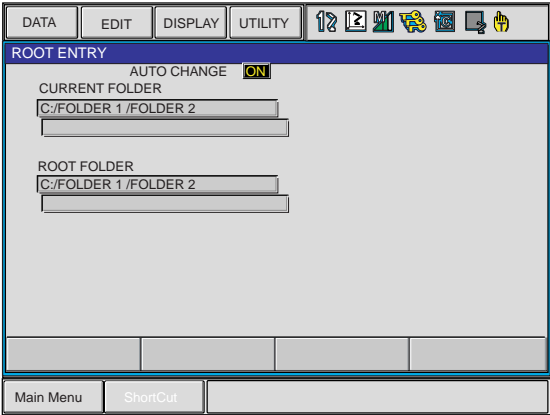
	Operation	Explanation
5	<p>Select {EDIT} --> {SETUP FOLDER} under the pull-down menu.</p> <p>Move the cursor to "AUTO CHANGE" and press [SELECT].</p>	<p>The initial folder is set in "ROOT FOLDER."</p>  <p>"AUTO CHANGE" shows "ON" and the initial folder setting becomes valid. Subsequently, every time {FD/PC CARD} --> {FOLDER} is selected, the initial folder that has been set becomes a current folder.</p>



When the initial folder is missing due to exchange of the Compact Flash, etc., "ERROR 3360: INVALID FOLDER" appears when selecting {LOAD}, {SAVE}, {VERIFY}, {DELETE} or {FOLDER} menu from {FD/PC CARD}, and simultaneously the initial folder becomes invalid. Set "ON" in "AUTO CHANGE" when the initial folder setting needs to be valid.

■ Saving Data

To download data from the memory of the NX100 to the external memory device, perform the following procedure.



Data such as PARAMETER, SYSTEM DATA, I/O DATA, and the batch data such as PARAMETER BATCH, BATCH CMOS, ALL CMOS AREA, that include PARAMETER, SYSTEM DATA, I/O DATA, contain the information specific to each robot controller. Those data are prepared as backup data for reloading into the controller used for saving. Loading the data from other controller may result in destruction or loss of critical system information.
Take extra care for the saved data.

Saving a Job

	Operation	Explanation
1	Select {FD/PC CARD} under the main menu.	
2	Select {SAVE}.	<p>The following window appears.</p>
3	Select {JOB}.	<p>The JOB LIST window appears.</p>

7.3 Operation Flow

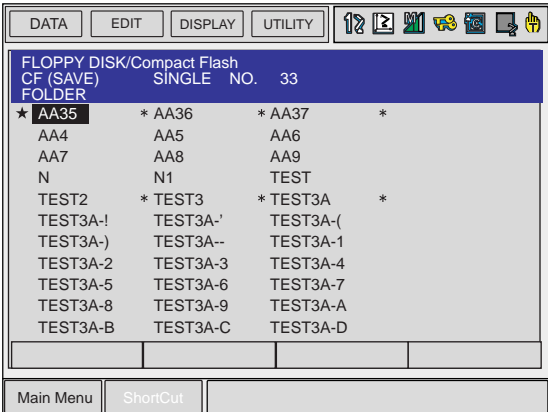
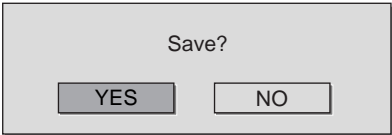
	Operation	Explanation
4	Select a job to be saved.	<p>The selected job is marked with "★."</p> 
5	Press [ENTER].	<p>The confirmation dialog box appears.</p> 
6	Select "YES."	<p>The selected job is saved.</p>

Saving a Condition File or General Data

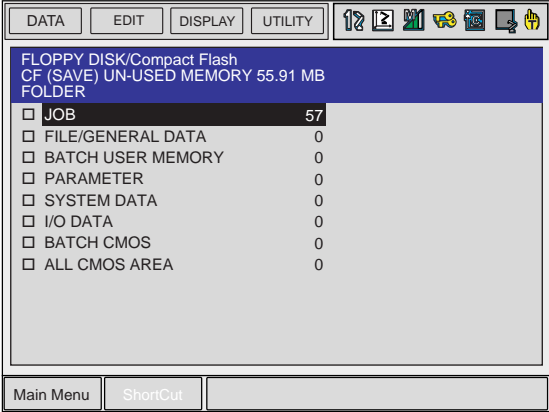
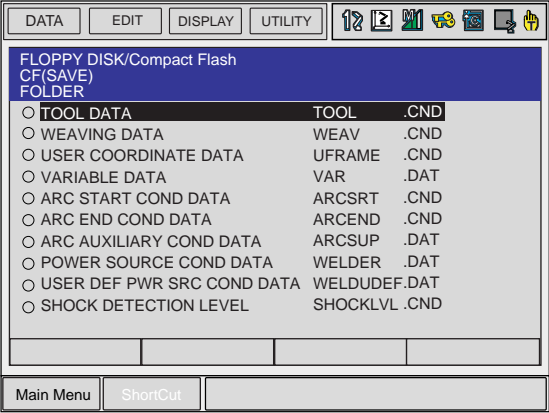
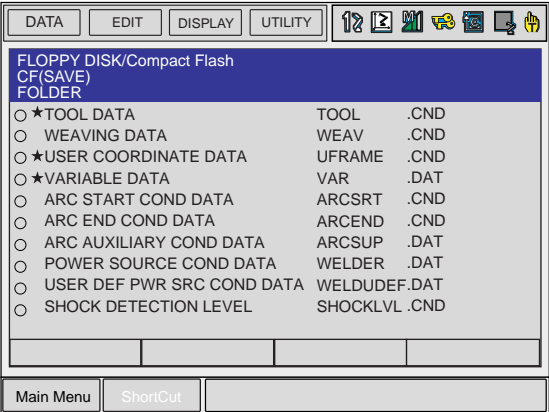
	Operation	Explanation
1	Select {FD/PC CARD} under the main menu.	
2	Select {SAVE}.	<p>The following window appears.</p> 
3	Move the cursor to {FILE/GENERAL DATA} and select.	<p>The selection window appears.</p>  <p>The content of the display varies in accordance with applications and options.</p>
4	Select condition files or general data to be saved.	<p>The selected files are marked with "★."</p> 

7.3 Operation Flow

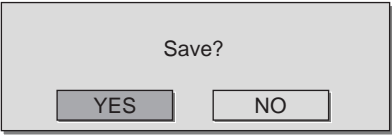
	Operation	Explanation
5	Press [ENTER].	The confirmation dialog box appears. 
6	Select "YES."	The selected files are saved.

Saving a Parameter

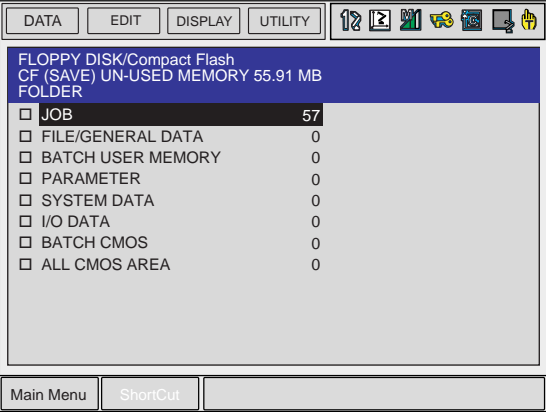
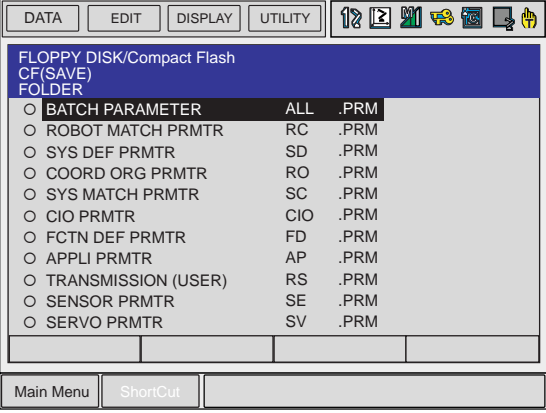
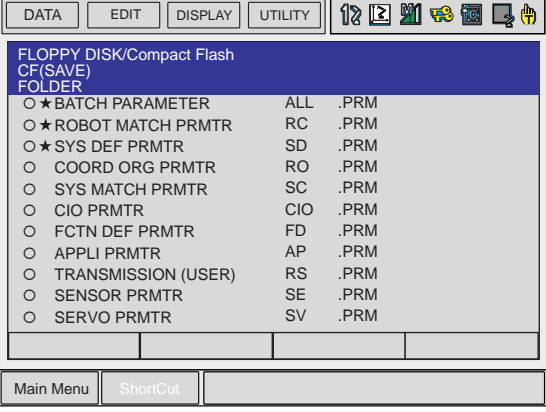
	Operation	Explanation
1	Select {FD/PC CARD} under the main menu.	
2	Select {SAVE}.	<p>The following window appears.</p> 
3	Move the cursor to {PARAMETER} and select.	<p>The selection window for parameters appears.</p> 
4	Select parameters to be saved.	<p>The selected parameters are marked with "★."</p> 

7.3 Operation Flow

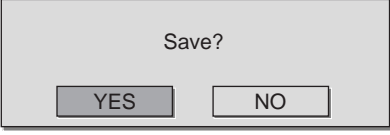
	Operation	Explanation
5	Press [ENTER].	The confirmation dialog box appears. 
6	Select "YES."	The selected parameters are saved.

Saving I/O Data

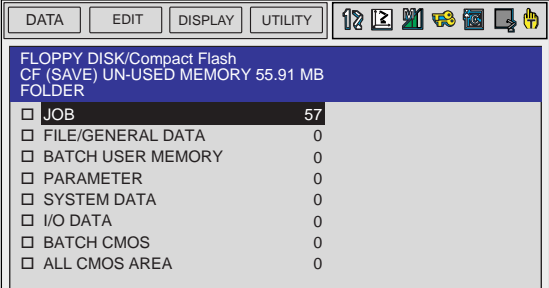
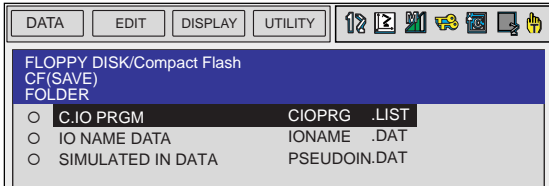
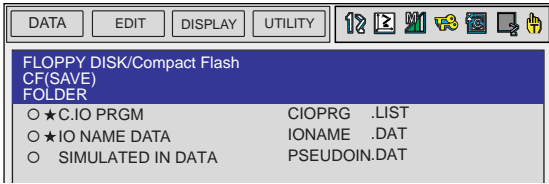
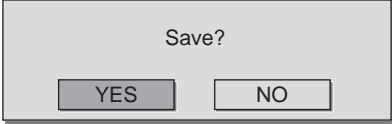
	Operation	Explanation
1	Select {FD/PC CARD} under the main menu.	
2	Select {SAVE}.	<p>The following window appears.</p> 
3	Move the cursor to {I/O DATA} and select.	<p>The selection window for I/O data appears.</p> 
4	Select I/O data to be saved.	<p>The selected I/O data are marked with "★."</p> 
5	Press [ENTER].	<p>The confirmation dialog box appears.</p> 
6	Select "YES."	The selected I/O data are saved.

Saving System Data

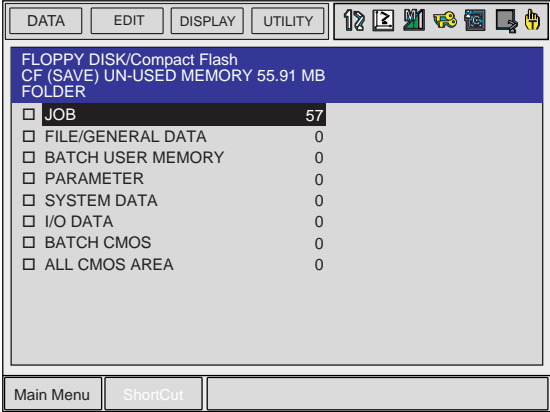
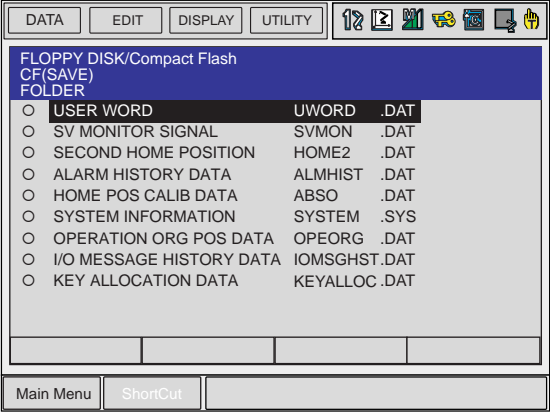
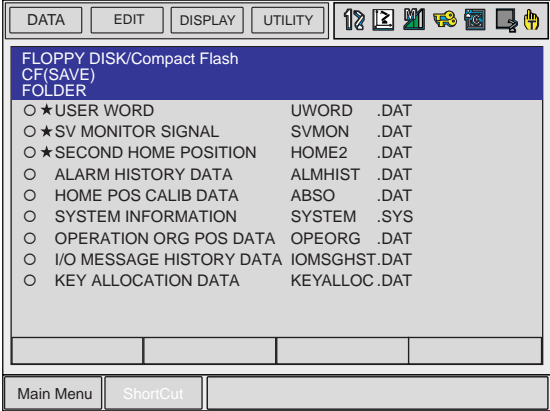
	Operation	Explanation																																				
1	Select {FD/PC CARD} under the main menu.																																					
2	Select {SAVE}.	<p>The following window appears.</p>  <p>The screenshot shows a window titled 'FLOPPY DISK/Compact Flash' with a sub-header 'CF (SAVE) UN-USED MEMORY 55.91 MB'. Below this is a list of folders with checkboxes and values:</p> <table border="1"> <tr><td><input checked="" type="checkbox"/></td><td>JOB</td><td>57</td></tr> <tr><td><input type="checkbox"/></td><td>FILE/GENERAL DATA</td><td>0</td></tr> <tr><td><input type="checkbox"/></td><td>BATCH USER MEMORY</td><td>0</td></tr> <tr><td><input type="checkbox"/></td><td>PARAMETER</td><td>0</td></tr> <tr><td><input type="checkbox"/></td><td>SYSTEM DATA</td><td>0</td></tr> <tr><td><input type="checkbox"/></td><td>I/O DATA</td><td>0</td></tr> <tr><td><input type="checkbox"/></td><td>BATCH CMOS</td><td>0</td></tr> <tr><td><input type="checkbox"/></td><td>ALL CMOS AREA</td><td>0</td></tr> </table> <p>At the bottom of the window are buttons for 'Main Menu' and 'ShortCut'.</p>	<input checked="" type="checkbox"/>	JOB	57	<input type="checkbox"/>	FILE/GENERAL DATA	0	<input type="checkbox"/>	BATCH USER MEMORY	0	<input type="checkbox"/>	PARAMETER	0	<input type="checkbox"/>	SYSTEM DATA	0	<input type="checkbox"/>	I/O DATA	0	<input type="checkbox"/>	BATCH CMOS	0	<input type="checkbox"/>	ALL CMOS AREA	0												
<input checked="" type="checkbox"/>	JOB	57																																				
<input type="checkbox"/>	FILE/GENERAL DATA	0																																				
<input type="checkbox"/>	BATCH USER MEMORY	0																																				
<input type="checkbox"/>	PARAMETER	0																																				
<input type="checkbox"/>	SYSTEM DATA	0																																				
<input type="checkbox"/>	I/O DATA	0																																				
<input type="checkbox"/>	BATCH CMOS	0																																				
<input type="checkbox"/>	ALL CMOS AREA	0																																				
3	Move the cursor to {SYSTEM DATA} and select.	<p>The selection window for system data appears.</p>  <p>The screenshot shows a window titled 'FLOPPY DISK/Compact Flash' with a sub-header 'CF(SAVE) FOLDER'. Below this is a list of system data files with radio buttons and file names:</p> <table border="1"> <tr><td><input checked="" type="radio"/></td><td>USER WORD</td><td>UWORD</td><td>.DAT</td></tr> <tr><td><input type="radio"/></td><td>SV MONITOR SIGNAL</td><td>SVMON</td><td>.DAT</td></tr> <tr><td><input type="radio"/></td><td>SECOND HOME POSITION</td><td>HOME2</td><td>.DAT</td></tr> <tr><td><input type="radio"/></td><td>ALARM HISTORY DATA</td><td>ALMHIST</td><td>.DAT</td></tr> <tr><td><input type="radio"/></td><td>HOME POS CALIB DATA</td><td>ABSO</td><td>.DAT</td></tr> <tr><td><input type="radio"/></td><td>SYSTEM INFORMATION</td><td>SYSTEM</td><td>.SYS</td></tr> <tr><td><input type="radio"/></td><td>OPERATION ORG POS DATA</td><td>OPEORG</td><td>.DAT</td></tr> <tr><td><input type="radio"/></td><td>I/O MESSAGE HISTORY DATA</td><td>IOMSGHST</td><td>.DAT</td></tr> <tr><td><input type="radio"/></td><td>KEY ALLOCATION DATA</td><td>KEYALLOC</td><td>.DAT</td></tr> </table> <p>At the bottom of the window are buttons for 'Main Menu' and 'ShortCut'.</p>	<input checked="" type="radio"/>	USER WORD	UWORD	.DAT	<input type="radio"/>	SV MONITOR SIGNAL	SVMON	.DAT	<input type="radio"/>	SECOND HOME POSITION	HOME2	.DAT	<input type="radio"/>	ALARM HISTORY DATA	ALMHIST	.DAT	<input type="radio"/>	HOME POS CALIB DATA	ABSO	.DAT	<input type="radio"/>	SYSTEM INFORMATION	SYSTEM	.SYS	<input type="radio"/>	OPERATION ORG POS DATA	OPEORG	.DAT	<input type="radio"/>	I/O MESSAGE HISTORY DATA	IOMSGHST	.DAT	<input type="radio"/>	KEY ALLOCATION DATA	KEYALLOC	.DAT
<input checked="" type="radio"/>	USER WORD	UWORD	.DAT																																			
<input type="radio"/>	SV MONITOR SIGNAL	SVMON	.DAT																																			
<input type="radio"/>	SECOND HOME POSITION	HOME2	.DAT																																			
<input type="radio"/>	ALARM HISTORY DATA	ALMHIST	.DAT																																			
<input type="radio"/>	HOME POS CALIB DATA	ABSO	.DAT																																			
<input type="radio"/>	SYSTEM INFORMATION	SYSTEM	.SYS																																			
<input type="radio"/>	OPERATION ORG POS DATA	OPEORG	.DAT																																			
<input type="radio"/>	I/O MESSAGE HISTORY DATA	IOMSGHST	.DAT																																			
<input type="radio"/>	KEY ALLOCATION DATA	KEYALLOC	.DAT																																			
4	Select system data to be saved.	<p>The selected system data are marked with "★."</p>  <p>The screenshot shows the same window as in step 3, but with the first three items marked with a star (★):</p> <table border="1"> <tr><td><input checked="" type="radio"/></td><td>★ USER WORD</td><td>UWORD</td><td>.DAT</td></tr> <tr><td><input checked="" type="radio"/></td><td>★ SV MONITOR SIGNAL</td><td>SVMON</td><td>.DAT</td></tr> <tr><td><input checked="" type="radio"/></td><td>★ SECOND HOME POSITION</td><td>HOME2</td><td>.DAT</td></tr> <tr><td><input type="radio"/></td><td>ALARM HISTORY DATA</td><td>ALMHIST</td><td>.DAT</td></tr> <tr><td><input type="radio"/></td><td>HOME POS CALIB DATA</td><td>ABSO</td><td>.DAT</td></tr> <tr><td><input type="radio"/></td><td>SYSTEM INFORMATION</td><td>SYSTEM</td><td>.SYS</td></tr> <tr><td><input type="radio"/></td><td>OPERATION ORG POS DATA</td><td>OPEORG</td><td>.DAT</td></tr> <tr><td><input type="radio"/></td><td>I/O MESSAGE HISTORY DATA</td><td>IOMSGHST</td><td>.DAT</td></tr> <tr><td><input type="radio"/></td><td>KEY ALLOCATION DATA</td><td>KEYALLOC</td><td>.DAT</td></tr> </table> <p>At the bottom of the window are buttons for 'Main Menu' and 'ShortCut'.</p>	<input checked="" type="radio"/>	★ USER WORD	UWORD	.DAT	<input checked="" type="radio"/>	★ SV MONITOR SIGNAL	SVMON	.DAT	<input checked="" type="radio"/>	★ SECOND HOME POSITION	HOME2	.DAT	<input type="radio"/>	ALARM HISTORY DATA	ALMHIST	.DAT	<input type="radio"/>	HOME POS CALIB DATA	ABSO	.DAT	<input type="radio"/>	SYSTEM INFORMATION	SYSTEM	.SYS	<input type="radio"/>	OPERATION ORG POS DATA	OPEORG	.DAT	<input type="radio"/>	I/O MESSAGE HISTORY DATA	IOMSGHST	.DAT	<input type="radio"/>	KEY ALLOCATION DATA	KEYALLOC	.DAT
<input checked="" type="radio"/>	★ USER WORD	UWORD	.DAT																																			
<input checked="" type="radio"/>	★ SV MONITOR SIGNAL	SVMON	.DAT																																			
<input checked="" type="radio"/>	★ SECOND HOME POSITION	HOME2	.DAT																																			
<input type="radio"/>	ALARM HISTORY DATA	ALMHIST	.DAT																																			
<input type="radio"/>	HOME POS CALIB DATA	ABSO	.DAT																																			
<input type="radio"/>	SYSTEM INFORMATION	SYSTEM	.SYS																																			
<input type="radio"/>	OPERATION ORG POS DATA	OPEORG	.DAT																																			
<input type="radio"/>	I/O MESSAGE HISTORY DATA	IOMSGHST	.DAT																																			
<input type="radio"/>	KEY ALLOCATION DATA	KEYALLOC	.DAT																																			

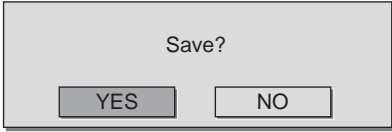
	Operation	Explanation
5	Press [ENTER].	The confirmation dialog box appears. 
6	Select "YES."	The selected system data are saved.



"BATCH USER MEMORY", "BATCH CMOS", and "ALL CMOS AREA" can be overwritten. As for "JOB", "FILE/GENERAL DATA", "PARAMETER", "SYSTEM DATA", and "I/O DATA", those data cannot be overwritten. In that case, delete the file of the same name in the folder beforehand or create a new folder so that the data can be stored inside.

Saving All User's Programs

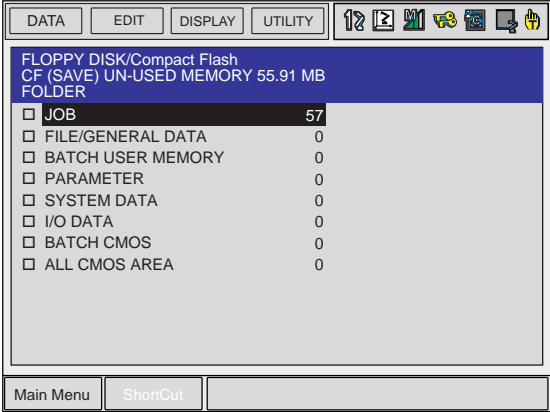
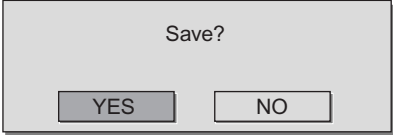
	Operation	Explanation
1	Select {FD/PC CARD} under the main menu.	
2	Select {SAVE}.	<p>The following window appears.</p> 
3	Move the cursor to {BATCH USER MEMORY} and select.	
4	Select "EXECUTE."	<p>The confirmation dialog box appears.</p> 
5	Select "YES."	All user's programs are saved.

Saving All CMOS Data

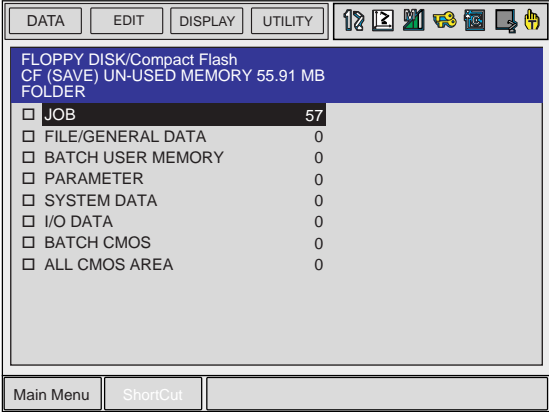
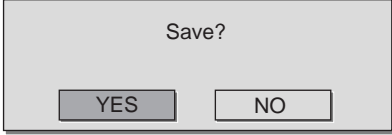
	Operation	Explanation
1	Select {FD/PC CARD} under the main menu.	
2	Select {SAVE}.	<p>The following window appears.</p> 
3	Move the cursor to {BATCH CMOS} and select.	
4	Select "EXECUTE."	<p>The confirmation dialog box appears.</p> 
5	Select "YES."	All CMOS data are saved.

Saving All Data in CMOS Area

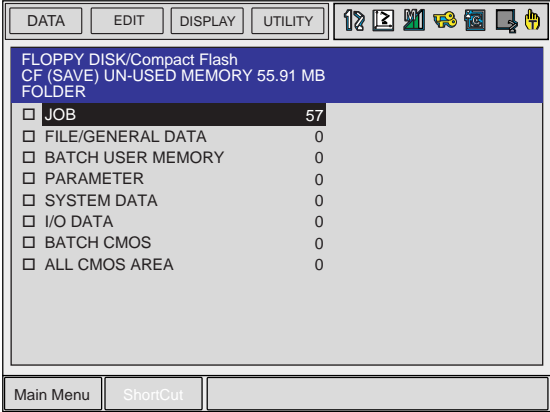
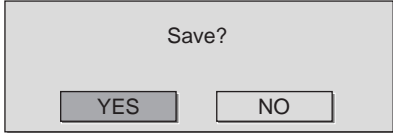
	Operation	Explanation
1	Select {FD/PC CARD} under the main menu.	
2	Select {SAVE}.	<p>The following window appears.</p> 
3	Move the cursor to {ALL CMOS AREA} and select.	
4	Select "EXECUTE."	<p>The confirmation dialog box appears.</p> 
5	Select "YES."	All data in CMOS area are saved.

■ Loading Data

To upload data from the external memory device to the memory of the NX100, follow the procedure in the following.



Data such as PARAMETER, SYSTEM DATA, I/O DATA, and the batch data such as PARAMETER BATCH, BATCH CMOS, ALL CMOS AREA, that include PARAMETER, SYSTEM DATA, I/O DATA, contain the information specific to each robot controller. Those data are prepared as backup data for reloading into the controller used for saving. Loading the data from other controller may result in destruction or loss of critical system information.
Take extra care for the saved data.

Loading a Job

	Operation	Explanation
1	Select {FD/PC CARD} under the main menu.	
2	Select {LOAD}.	<p>The following window appears.</p>
3	Select {JOB}.	<p>The job selection window appears.</p>

7.3 Operation Flow

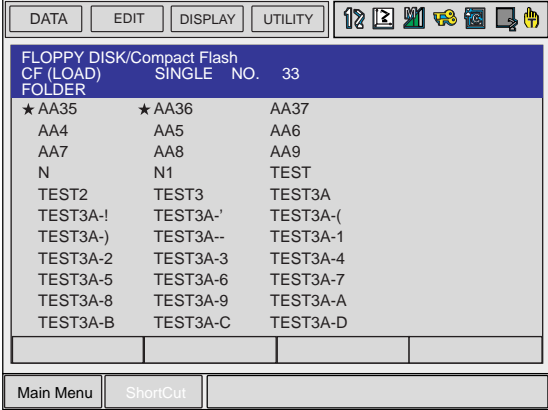
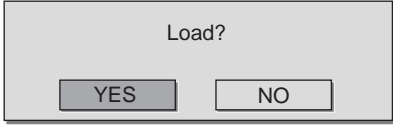
	Operation	Explanation
4	Select a job to be loaded.	<p>The selected jobs are marked with “★.”</p> 
5	Press [ENTER].	<p>The confirmation dialog box appears.</p> 
6	Select “YES.”	The selected jobs are loaded.

Loading a Condition File or General Data

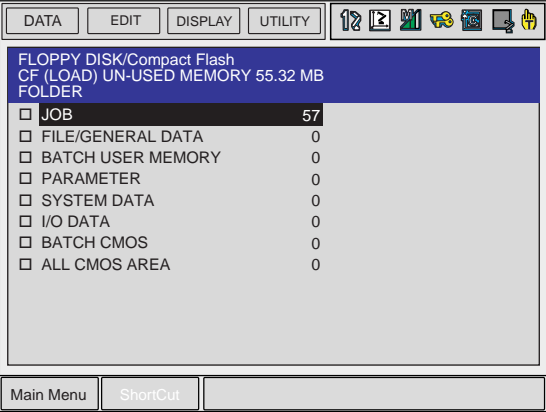
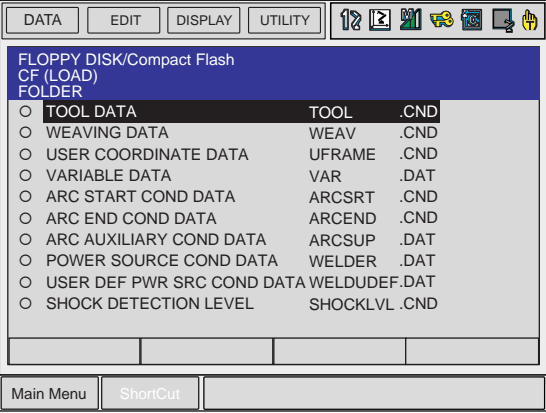
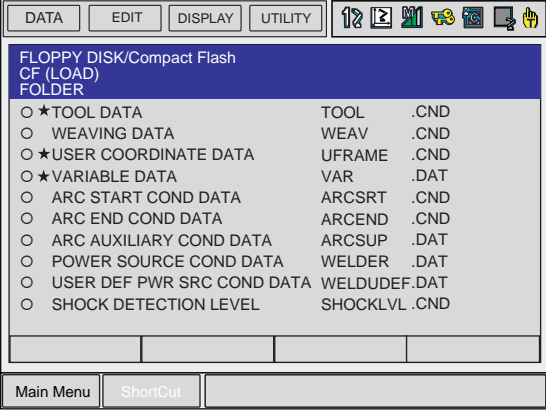
	Operation	Explanation
1	Select {FD/PC CARD} under the main menu.	
2	Select {LOAD}.	<p>The following window appears.</p> 
3	Move the cursor to {FILE/GENERAL DATA} and select.	<p>The selection window for condition file or general data appears.</p> 
4	Select a condition file or general data to be loaded.	<p>The selected files are marked with "★."</p> 

7.3 Operation Flow

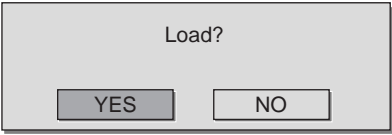
	Operation	Explanation
5	Press [ENTER].	The confirmation dialog box appears. 
6	Select "YES."	The selected files are loaded.

Loading a Parameter

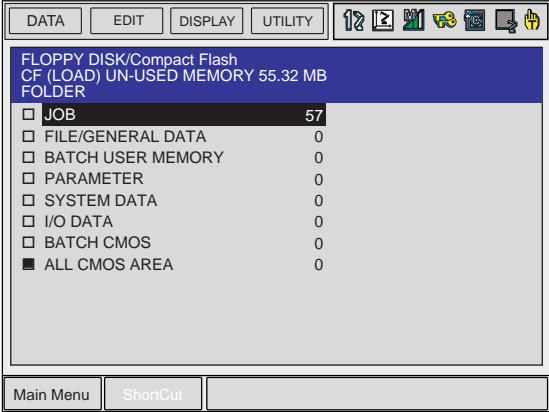
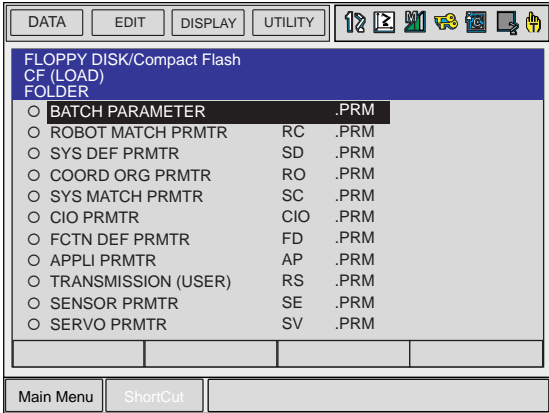
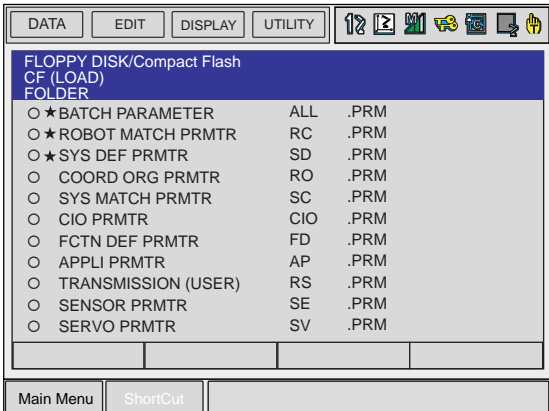
	Operation	Explanation
1	Select {FD/PC CARD} under the main menu.	
2	Select {LOAD}.	<p>The following window appears.</p> 
3	Move the cursor to {PARAMETER} and select.	<p>The selection window for parameters appears.</p> 
4	Select parameters to be loaded.	<p>The selected parameters are marked with “★.”</p> 

7.3 Operation Flow

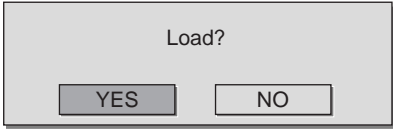
	Operation	Explanation
5	Press [ENTER].	The confirmation dialog box appears. 
6	Select "YES."	The selected parameters are loaded.

Loading I/O Data

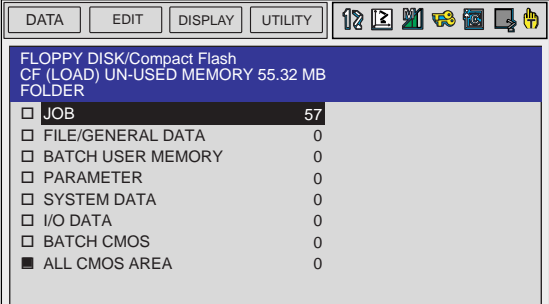
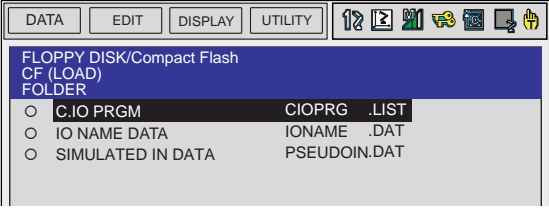
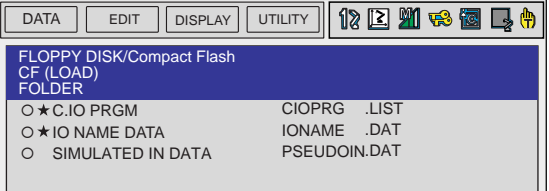
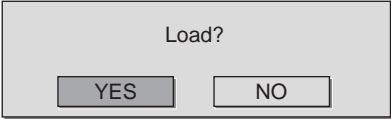
	Operation	Explanation
1	Select {FD/PC CARD} under the main menu.	
2	Select {LOAD}.	<p>The following window appears.</p> 
3	Move the cursor to {I/O DATA} and select.	<p>The selection window for I/O data appears.</p> 
4	Select I/O data to be loaded.	<p>The selected I/O data are marked with “★.”</p> 
5	Press [ENTER].	<p>The confirmation dialog box appears.</p> 
6	Select “YES.”	The selected I/O data are loaded.

Loading System Data

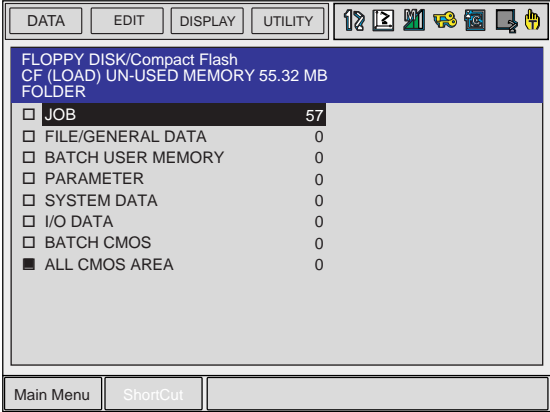
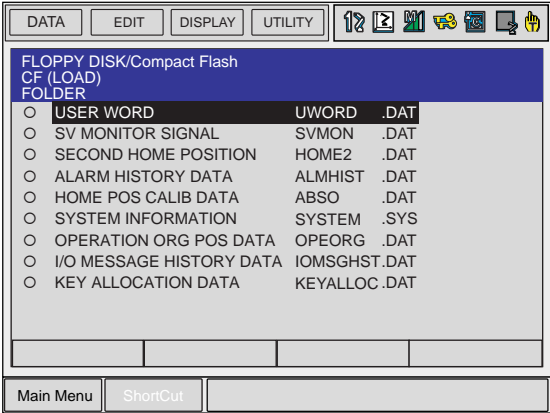
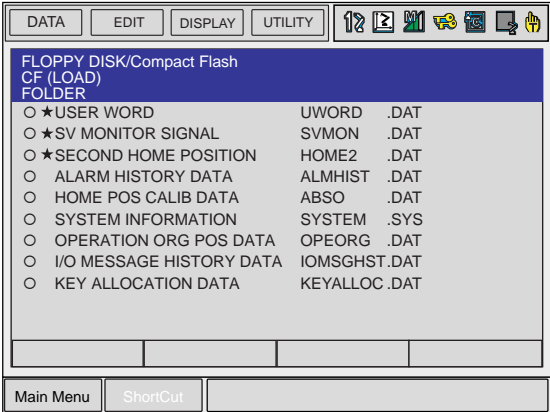
	Operation	Explanation
1	Select {FD/PC CARD} under the main menu.	
2	Select {LOAD}.	<p>The following window appears.</p> 
3	Move the cursor to {SYSTEM DATA} and select.	<p>The selection window for system data appears.</p> 
4	Select system data to be loaded.	<p>The selected system data are marked with "★."</p> 

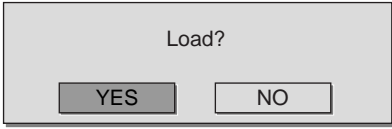
	Operation	Explanation
5	Press [ENTER].	The confirmation dialog box appears. 
6	Select "YES."	The selected system data are loaded.

Loading All User's Programs

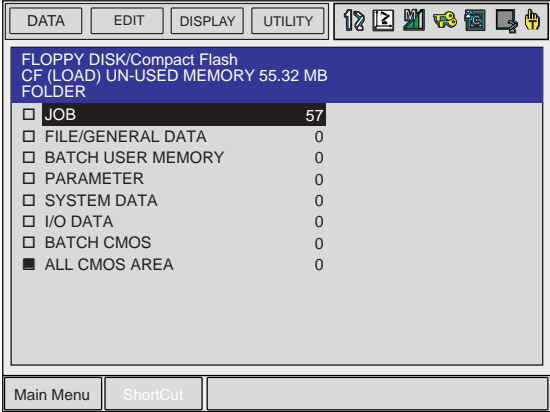
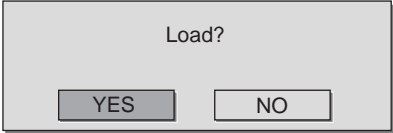
	Operation	Explanation
1	Select {FD/PC CARD} under the main menu.	
2	Select {LOAD}.	<p>The following window appears.</p> 
3	Move the cursor to {BATCH USER MEMORY} and select.	
4	Select "EXECUTE."	<p>The confirmation dialog box appears.</p> 
5	Select "YES."	All user's programs are loaded.

Loading All CMOS Data

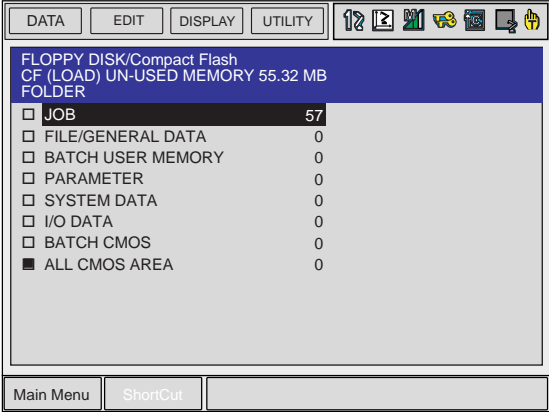
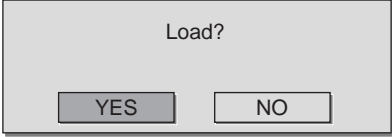
	Operation	Explanation
1	Select {FD/PC CARD} under the main menu.	
2	Select {LOAD}.	<p>The following window appears.</p> 
3	Move the cursor to {BATCH CMOS} and select.	
4	Select "EXECUTE."	<p>The confirmation dialog box appears.</p> 
5	Select "YES."	All CMOS data are loaded.

■ Verifying Data



Follow the procedure below to verify data in the memory of the NX100 with data saved in the external memory device.



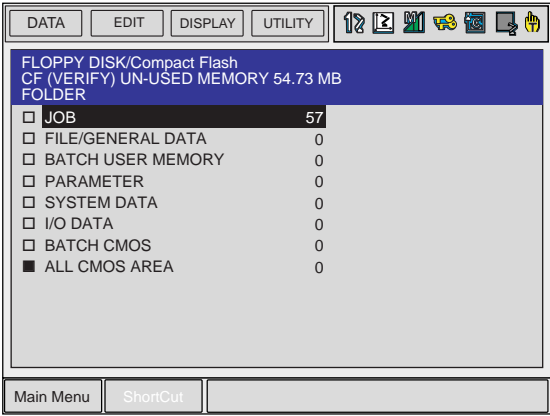
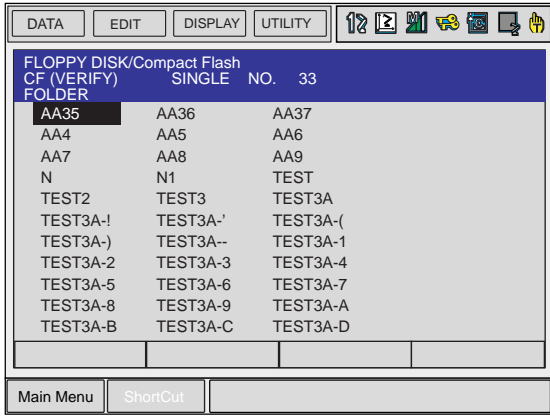

This function cannot be executed with “BATCH USER MEMORY,” “BATCH CMOS,” or “ALL CMOS AREA” specified.

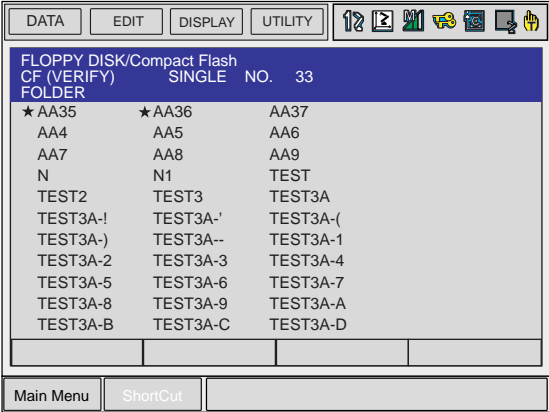
Verifying a Job

	Operation	Explanation
1	Select {FD/PC CARD} under the main menu.	
2	Select {VERIFY}.	<p>The following window appears.</p> 
3	Select {JOB}.	<p>The job selection window appears.</p> 

	Operation	Explanation
4	Select a job to be verified.	<p>The selected jobs are marked with "★."</p> 
5	Press [ENTER].	<p>The confirmation dialog box appears.</p> 
6	Select "YES."	The selected jobs are verified.

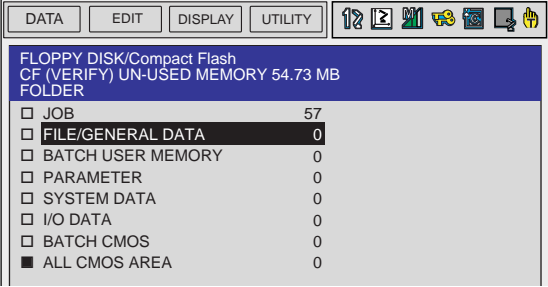
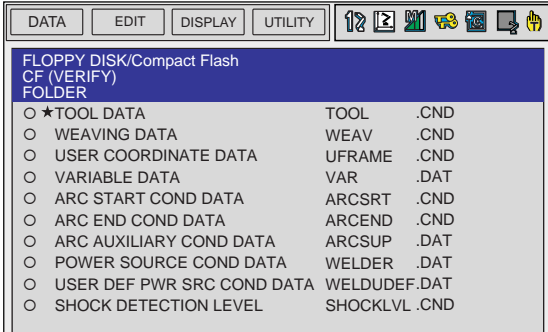
Verifying a File

	Operation	Explanation
1	Select {FD/PC CARD} under the main menu.	
2	Select {VERIFY}.	<p>The following window appears.</p> 
3	Select the group of the file to be verified.	
4	Select a file to be verified.	<p>The selected files are marked with "★."</p> 
5	Press [ENTER].	<p>The confirmation dialog box appears.</p> 
6	Select "YES."	The selected files are verified.

■ Deleting Data

Follow the procedure below to delete a file or files on an external memory device.

Deleting a Job

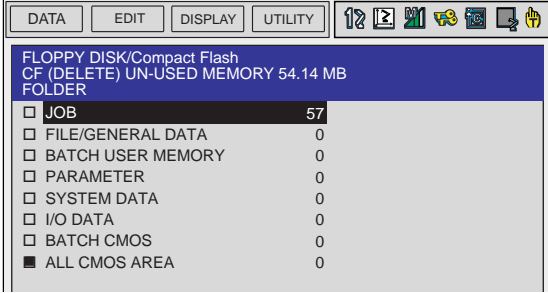
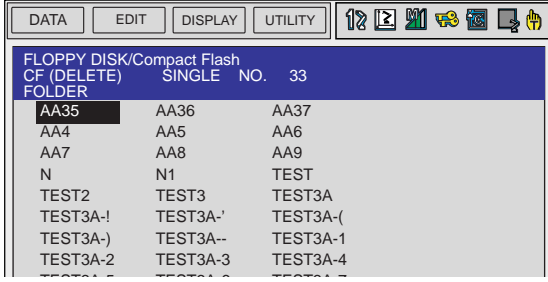
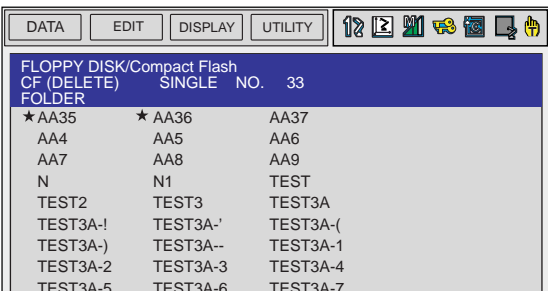
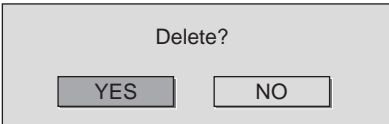
	Operation	Explanation
1	Select {FD/PC CARD} under the main menu.	
2	Select {DELETE}.	The following window appears. 
3	Select {JOB}.	The job selection window appears. 
4	Select a job to be deleted.	The selected jobs are marked with "★." 
5	Press [ENTER].	The confirmation dialog box appears. 
6	Select "YES."	The selected jobs are deleted.

Deleting a File

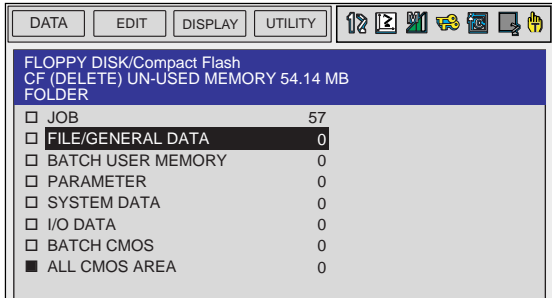
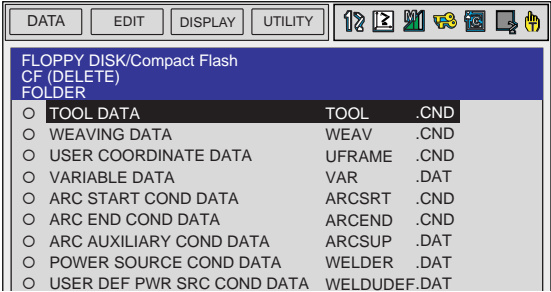
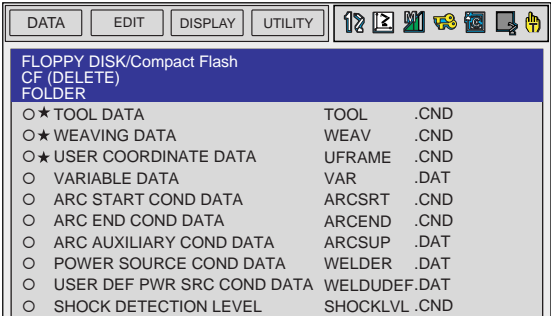
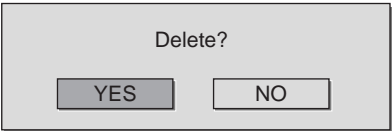
	Operation	Explanation
1	Select {FD/PC CARD} under the main menu.	
2	Select {DELETE}.	<p>The following window appears.</p>  <p>The screenshot shows a window titled 'FLOPPY DISK/Compact Flash' with a sub-header 'CF (DELETE) UN-USED MEMORY 54.14 MB'. Below this is a 'FOLDER' list:</p> <ul style="list-style-type: none"> <input type="checkbox"/> JOB 57 <input checked="" type="checkbox"/> FILE/GENERAL DATA 0 <input type="checkbox"/> BATCH USER MEMORY 0 <input type="checkbox"/> PARAMETER 0 <input type="checkbox"/> SYSTEM DATA 0 <input type="checkbox"/> I/O DATA 0 <input type="checkbox"/> BATCH CMOS 0 <input checked="" type="checkbox"/> ALL CMOS AREA 0
3	Select the group of the file to be deleted.	 <p>The screenshot shows the same window as above, but with a list of files:</p> <ul style="list-style-type: none"> <input checked="" type="radio"/> TOOL DATA TOOL .CND <input type="radio"/> WEAVING DATA WEAV .CND <input type="radio"/> USER COORDINATE DATA UFRAME .CND <input type="radio"/> VARIABLE DATA VAR .DAT <input type="radio"/> ARC START COND DATA ARCSRT .CND <input type="radio"/> ARC END COND DATA ARCELD .CND <input type="radio"/> ARC AUXILIARY COND DATA ARCSUP .DAT <input type="radio"/> POWER SOURCE COND DATA WELDER .DAT <input type="radio"/> USER DEF PWR SRC COND DATA WELDUDEF.DAT
4	Select a file to be deleted.	<p>The selected files are marked with "★."</p>  <p>The screenshot shows the same window as above, but with the first three files marked with a star:</p> <ul style="list-style-type: none"> <input checked="" type="radio"/> ★ TOOL DATA TOOL .CND <input checked="" type="radio"/> ★ WEAVING DATA WEAV .CND <input checked="" type="radio"/> ★ USER COORDINATE DATA UFRAME .CND <input type="radio"/> VARIABLE DATA VAR .DAT <input type="radio"/> ARC START COND DATA ARCSRT .CND <input type="radio"/> ARC END COND DATA ARCELD .CND <input type="radio"/> ARC AUXILIARY COND DATA ARCSUP .DAT <input type="radio"/> POWER SOURCE COND DATA WELDER .DAT <input type="radio"/> USER DEF PWR SRC COND DATA WELDUDEF.DAT <input type="radio"/> SHOCK DETECTION LEVEL SHOCKLVL .CND
5	Press [ENTER].	<p>The confirmation dialog box appears.</p>  <p>The screenshot shows a simple dialog box with the title 'Delete?' and two buttons: 'YES' and 'NO'.</p>
6	Select "YES."	<p>The selected files are deleted.</p>

■ Job Selection Mode

The method of selecting a job and various data files when loading, saving, verifying, and deleting are described in the following:

- Individual Selection
Jobs and data files are selected individually one at a time.
- Batch Selection
Jobs and data files are selected all at one time.
- Marker (*) Selection
Loading: selects the files in the external memory device.
Saving: selects the files in the memory of the NX100.
Verifying: selects both the files in the external memory device and in the memory of the NX100.

Using Individual Selection

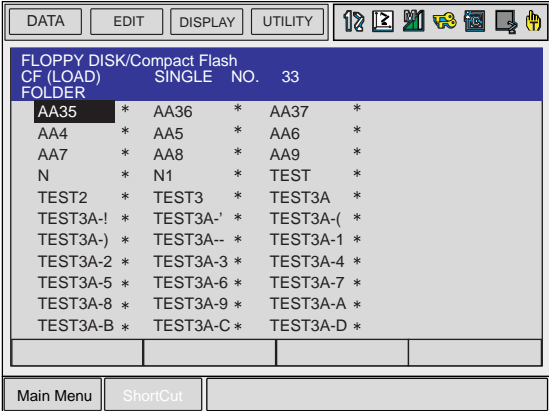
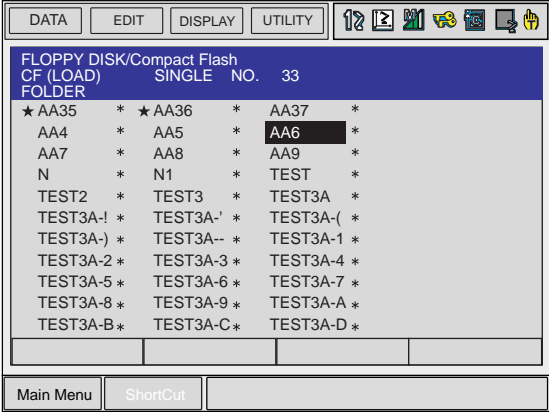
	Operation	Explanation
1	In either the external memory JOB LIST window or the file selection window, move the cursor to a job or a file to be selected.	 <p>The screenshot shows a file selection interface with a menu bar (DATA, EDIT, DISPLAY, UTILITY) and a toolbar. The main display area is titled 'FLOPPY DISK/Compact Flash CF (LOAD) SINGLE NO. 33 FOLDER'. Below the title is a list of files and folders, each preceded by an asterisk (*). The file 'AA35' is highlighted in black, indicating it is selected. The list includes: AA35, AA4, AA7, N, TEST2, TEST3A-!, TEST3A-), TEST3A-2, TEST3A-5, TEST3A-8, TEST3A-B, AA36, AA5, AA8, N1, TEST3, TEST3A-', TEST3A--, TEST3A-3, TEST3A-6, TEST3A-9, TEST3A-C, AA37, AA6, AA9, TEST, TEST3A, TEST3A-(, TEST3A-1, TEST3A-4, TEST3A-7, TEST3A-A, and TEST3A-D.</p>
2	<p>Press [SELECT]. Move the cursor to a file needed and press [SELECT] again.</p> <p>*To cancel the selected items, select {EDIT} and then {CANCEL SELECT}.</p>	<p>The selected jobs are marked with “★.”</p>  <p>The screenshot shows the same file selection interface as above. In this view, the files 'AA35' and 'AA36' are both marked with an asterisk (★) to indicate they are selected. The file 'AA6' is now highlighted in black, indicating it is the current selection. The rest of the file list remains the same.</p>

Using Batch Selection

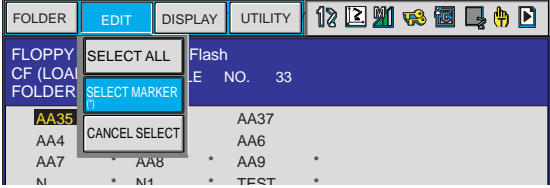
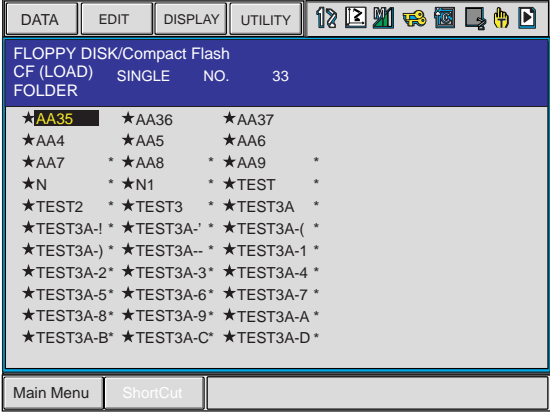
	Operation	Explanation
1	In either the external memory JOB LIST window or the file selection window, select {EDIT} under the menu.	<p>The pull-down menu appears.</p> 
2	<p>Select {SELECT ALL}.</p> <p>*To cancel the selected items, select {EDIT} and then {CANCEL SELECT}.</p>	<p>All jobs are selected.</p> 

Using Marker (*) Selection

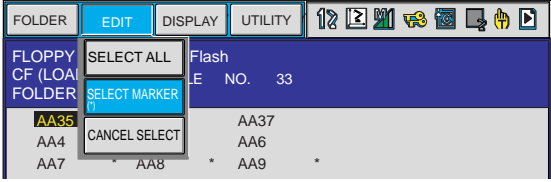
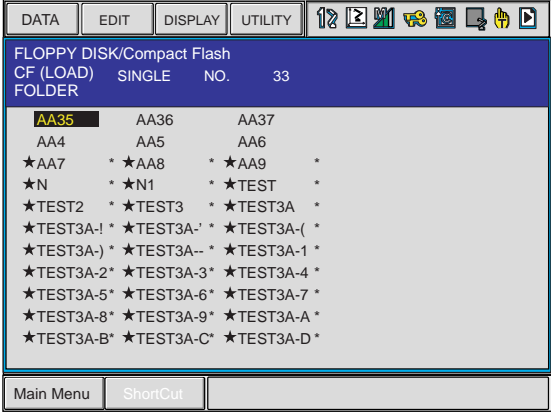
	Operation	Explanation
1	In either the external memory JOB LIST window or the file selection window, select {EDIT} under the menu.	<p>The pull-down menu appears.</p> 
2	<p>Select {SELECT MARKER (*)}.</p> <p>*To cancel the selected items, select {EDIT} and then {CANCEL SELECT}.</p>	

8 Parameter

8.1 Parameter Configuration

The parameters of NX100 can be classified into the following seven:

Motion Speed Setting Parameter

Determines the manipulator motion speed for jog operation at teaching, test operation, or playback operation.

Mode Operation Setting Parameter

Makes the setting for various operations in the teach mode or remote mode.

Parameter according to Interference Area

Limits the P-point maximum envelope of the manipulator or sets the interference area for axis interference or cubic interference.

Parameter according to Status I/O

Sets the parity check or I/O setting for user input/output signals.

Parameter according to Coordinated or Synchronized Operation

Makes the settings for coordinated or synchronized operations between manipulators or between manipulators and stations.

Parameter for Other Functions or Applications

Makes the settings for other functions or applications.

Hardware Control Parameter

Makes the hardware settings for fan alarm or relay operation, etc.



S1CxG Parameters

The initial setting of S1CxG parameters depends on the manipulator model. For a system in which two manipulators are controlled, the following two types of parameters are used: S1C1G type and S1C2G type.

8.2 Motion Speed Setting Parameters

These parameters set the manipulator motion speed for jog operation at teaching, test operation, or playback operation.

■ S1CxG000: IN-GUARD SAFE OPERATION MAX. SPEED

Units: 0.01%

The upper speed limit is set for in-guard safe operation. While the in-guard safe operation command signal is being input, the TCP speed is limited to the TCPmax speed.

■ S1CxG001: DRY-RUN SPEED

Units: 0.01%

This is a dry-run operation speed setting value used when checking the path. Take safety into consideration when setting changes are unnecessary.

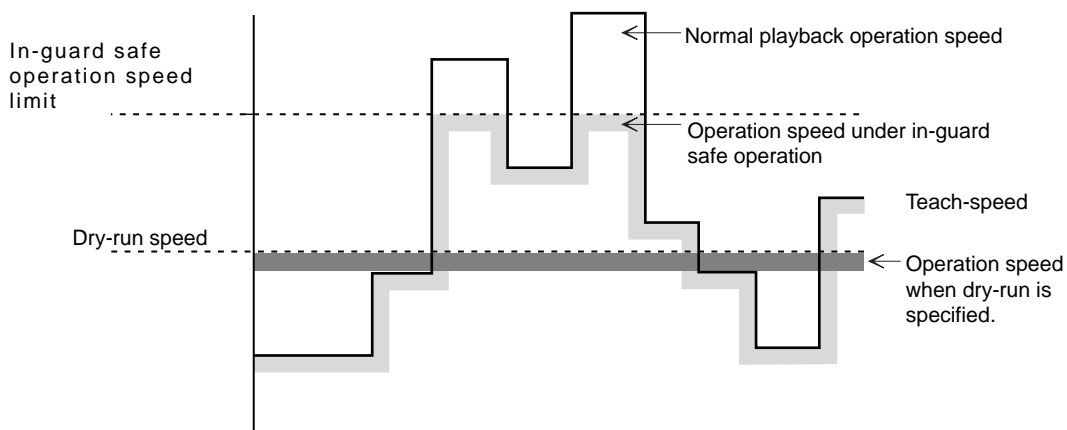

■ S1CxG002 to S1CxG009: JOINT SPEED FOR REGISTRATION

Units: 0.01%

The value set in these parameters is registered as the joint speed for each speed level when teaching the position data with the programming pendant. The percentage corresponding to the set value at each level is registered as 100% of the value set in the playback speed limit. Values greater than those set as speed limit values cannot be set.

■ S1CxG010 to S1CxG017: LINEAR SPEED FOR REGISTRATION

Units: 0.1mm/s

The value set in these parameters is registered as the linear speed for each speed level when teaching the position data with the programming pendant. Values greater than those set as playback speed limit values cannot be set.

■ S1CxG018 to S1CxG025: POSITION ANGLE SPEED

Units: 0.1°/s

The value set in these parameters is registered as the position angle speed for each speed level when teaching the position data with the programming pendant. Values greater than those set as playback speed limit cannot be set.

■ S1CxG026 to S1CxG029: JOG OPERATION ABSOLUTE VALUE SPEED

Units: 0.1mm/s

These are setting values of jog operation speed set by the programming pendant. Values greater than those set as jog operation speed limit value cannot be set.

- Low level : Jog operation speed when “LOW” manual speed is specified.
- Medium level : Jog operation speed when “MEDIUM” manual speed is specified.
- High level : Jog operation speed when “HIGH” manual speed is specified.
- High-speed-level : Jog operation speed when [HIGH SPEED] is pressed.

■ S1CxG030 to S1CxG032: INCHING MOVE AMOUNT

These parameters specify the amount per move at inching operation by the programming pendant. The referenced parameter differs according to the operation mode at inching operation.

- Joint Operation : 1 to 10 pulses in units of 1 pulse
- Cartesian/cylindrical, user, tool : 0.01 to 2.55mm in units of 0.01mm
- Motion about TCP : 0.1 to 1.0° in units of 0.1°

■ S1CxG033 to S1CxG040: POSITIONING ZONE

This parameter value will be referenced when positioning is specified with the “MOVE” instruction: MOVJ (joint movement) or MOVL (linear movement).

<Example> MOVL V=100.0 PL=1

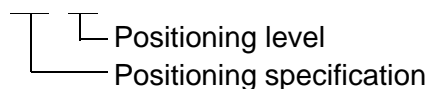

The value set in this parameter specifies the range to enter in relation to the teaching point for that step positioning. After entering the specified positioning zone, the manipulator starts moving to the next step. The system is also set up so inward turning operation is carried out in the moving section when moving to the next path; speed changeover is smooth.

Since operation will be turning inward during playback, as shown in the following diagram, use setting values taking safety aspects into consideration.

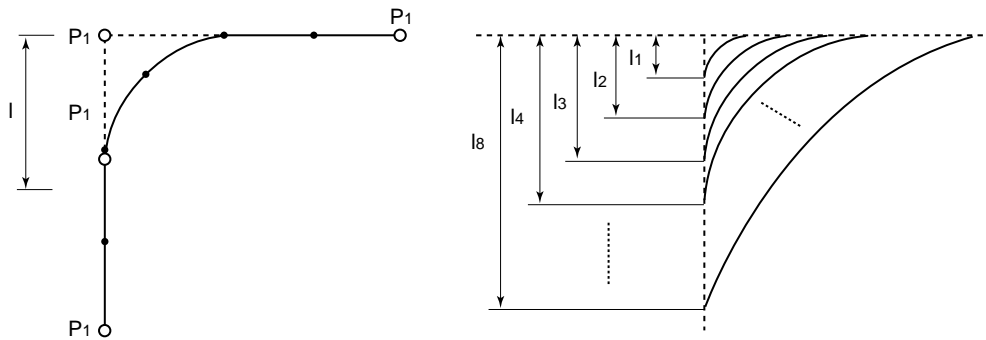

This process becomes effective when change in direction of steps is between 250° and 155° .



Position Level

Position levels are divided into nine stages of 0 to 8 with the “MOV” instruction.
e.g. `MOVL V=500 PL=1` (PL:Position Level)

The functions at each level are as follows:

0: Complete positioning to the target point

1 to 8: Inward turning operation

Following are explanations of the respective processing details and their relations with the parameter.

- Level 0

Determines positioning completion when the amount of deviation (number of pulses) to the target point of each axis comes within the position set zone specified by the parameter.

After the positioning completes, the instruction system starts instruction to the next target point.

- Level 1 to 8

Recognizes virtual positioning before the target point. The distance of the virtual target position from the target point is specified at the positioning level.

Distance data corresponding to each level are set in the parameter. Determination of the virtual target position is carried out in the instruction system.

Set zone: The zone of each positioning level set in the parameter. (μm)

■ S1CxG044: LOW-SPEED START

Units: 0.01%

This parameter specifies max. speed at low speed start. Specify the starting method for “initial operation speed of manipulator” (S2C169).

■ S1CxG045 to S1CxG048: JOG OPERATION LINK SPEED

Units: 0.01%

These parameters prescribe the link speed at jog operation by the programming pendant. Specify the percentage (%) for the jog operation speed limit, the joint max. speed.

S1CxG045: Jog operation link speed at level “LOW”

S1CxG046: Jog operation link speed at level “MEDIUM”

S1CxG047: Jog operation link speed at level “HIGH”

S1CxG048: Jog operation link speed at level “HIGH SPEED”

■ S1CxG056: WORK HOME POSITION RETURN SPEED

Units: 0.01%

This parameter specifies the speed for returning to work home position against the maximum speed.

■ S1CxG057: SEARCH MAX. SPEED

Units: 0.1mm/s

This parameter specifies the max. speed for searching.

■ S2C153: POSTURE CONTROL AT CARTESIAN OPERATION OF JOG

This parameter specifies whether or not posture control is performed at cartesian operation of “JOG” by the programming pendant. Use posture control unless a special manipulator model is used.

0: With posture control

1: Without posture control

■ S2C154: OPERATION IN USER COORDINATE SYSTEM (WHEN EXTERNAL REFERENCE POINT CONTROL FUNCTION USED)

This parameter specifies the TCP or reference point of motion about TCP when the external reference point control function is used and the user coordinate system is selected by the programming pendant.

0: When manipulator TCP is selected

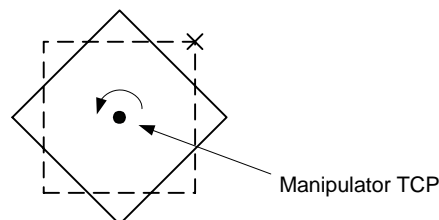

1: When external reference point is selected

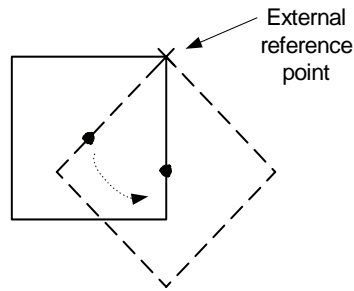

■ **S2C238: CONTROLLED GROUP JOB TEACHING POSITION CHANGE**

This parameter is used to change only the job teaching position of controlled group axis.

- 0: Not changed
- 1: Changed

■ **S2C324, S2C325: OPERATION AFTER RESET FROM PATH DEVIATION**

These parameters specify the method of restarting the manipulator that has deviated from the normal path such as an emergency stop or jog operation.

- 0: Move to the indicated step (initial setting).
- 1: After moving back to the deviated position, move to the indicated step.
- 2: Move back to the deviated position and stop.

S2C324

Parameter Setting Value	Movement When Restarting
0	<p>Move to next step.</p>
1	<p>After moving back to the deviated position, move to the indicated step.</p>

8.2 Motion Speed Setting Parameters

S2C324

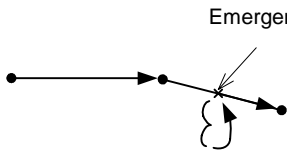
Parameter Setting Value	Movement When Restarting
2	 <p>Move to the path deviated position and stop. When restarting, move to the indicated step.</p>

S2C325

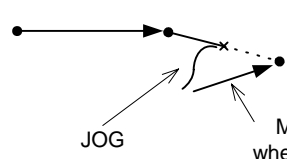
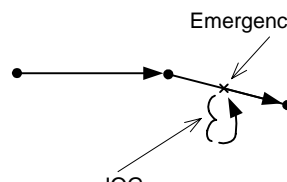
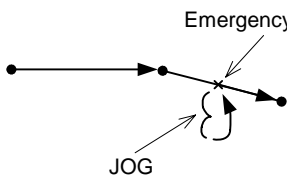
Parameter Setting Value	Movement When Restarting
0	<p>Move to the next step.</p>  <p>Move to next step.</p>
1	<p>After moving back to the deviated position, move to the indicated step.</p>  <p>Move to the path deviated position and then move to the indicated step.</p>
2	 <p>Move to the path deviated position and stop. When restarting, move to the indicated step.</p>

NOTE

- To the path deviated position, the manipulator moves in a straight line at low speed operation (SICxG044).
It is linear movement. After resetting from deviation, the speed becomes the same as taught speed.
- The initial setting (prior to shipping) is 0: The manipulator moves in a straight line from the present position to the indicated step.

■ S2C326: DEVIATED POSITION

This parameter specifies whether deviated position is to be robot current (reference) position or feedback position.

- 0: Return to the feedback position.
- 1: Return to the current value (reference) position.

When emergency stop is applied during high-speed motion, the deviated position differs from the robot current value (reference) position and feedback position as shown in the following.

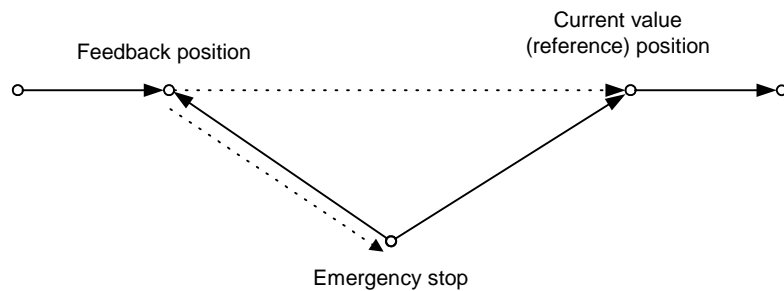

■ S2C327: CIRCULAR INTERPOLATION TOOL POSITION CONTROL

This parameter selects tool position control methods at circular interpolation operation.

- 0: Fixed angle position

Interpolation is performed depending on the position change viewed from the base coordinate.

As the figure below (left) shows, when tool position viewed from outside is not significantly changed and that position is mainly taught at teaching, this setting is required.

- 1: Rotating position by circular arc path

Interpolation is performed depending on the position change corresponding to circular arc path.

As the figure below (right) shows, when tool position corresponding to circular arc path (tool position viewed from the center of the circular arc) is not significantly changed, and that position is mainly taught at teaching, this setting is required.

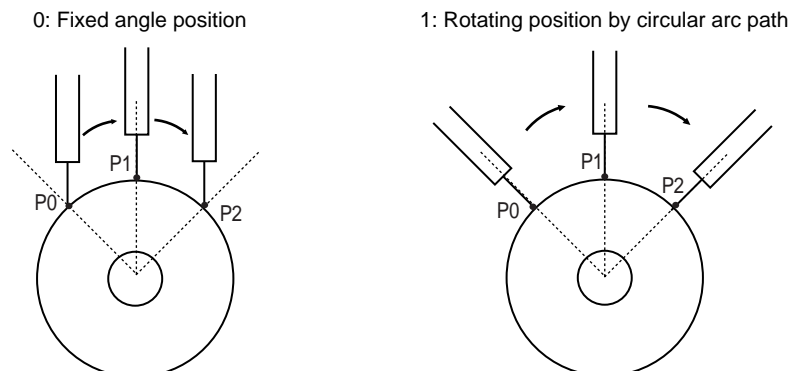

■ S2C515: EMERGENCY STOP CURSOR ADVANCE CONTROL FUNCTION

This parameter specifies whether to use the cursor advance control function or not.

- 0: Not use
- 1: Use

■ S2C516: EMERGENCY STOP CURSOR ADVANCE CONTROL FUNCTION CONT PROCESS COMPLETION POSITION

Units: %

When the manipulator stops during moving inner corner by CONT process, this parameter specifies which position of the inner corner should be considered as the end of step.

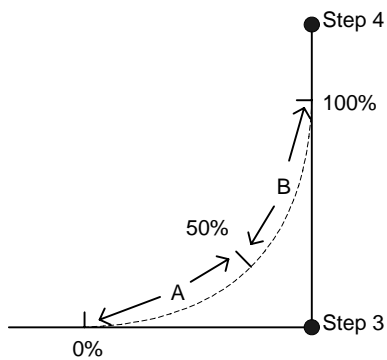

When 50% is set, moves to Step 3 if the manipulator stops in A section, and to Step 4 if the manipulator stops in B section.

■ S2C517: EMERGENCY STOP ADVANCE CONTROL FUNCTION WORK START INSTRUCTION STEP MOTION COMPLETION DELAY TIME

Units: ms

In order to recognize securely the completion of motion to the step of work start instruction (such as ARCON instruction), this parameter specifies the delay time for motion completion of the work start instruction step only.

■ S2C560: BASE AXIS OPERATION KEY ALLOCATION SETTING

Parameter Setting and Jog Operation Key Allocation

Coordinates/Parameter	S2C560= "0"	S2C560= "1"
Joint	Axis number order	Specified
Cylindrical	Axis number order	Specified
Cartesian	Specified	Specified
Tool	Specified	Specified
User	Specified	Specified

Axis number order: X: First axis, Y: Second axis, Z: Third axis

Specified: X: X-direction (RECT-X), Y: Y-direction (RECT-Y), Z: Z-direction (RECT-Z)

■ S3C806 to S3C808: POSITION CORRECTING FUNCTION DURING PLAYBACK

These parameters specify the necessary data for position correcting function (PAM) during playback operation.

- S3C806 Specifies the limit of position correcting range (Units: μm)
- S3C807 Specifies the limit of speed correcting range (Units: 0.01%)
- S3C808 Specifies the correcting coordinates
 - 0 : Base
 - 1 : Robot
 - 2 : Tool
 - 3 : User 1
 - to
 - 26:User 24

8.3 Mode Operation Setting Parameters

These parameters set various operations in the teach mode or remote mode.

■ S2C147: SECURITY MODE WHEN CONTROL POWER SUPPLY IS TURNED ON

The operation level when the control power supply is turned ON is set.

- 0: Operation Mode
- 1: Editing Mode
- 2: Management Mode

■ S2C148: SELECTION OF CARTESIAN/CYLINDRICAL

This parameter specifies whether the cartesian mode or cylindrical mode is affected when cartesian/cylindrical mode is selected by operation (coordinate) mode selection at axis operation of programming pendant. This specification can be done on the TEACHING CONDITION window.

- 0: Cylindrical mode
- 1: Cartesian mode



■ S2C149: COORDINATE SWITCHING PROHIBITED

This parameter prohibits switching coordinates during JOG operation by the programming pendant.

- 0: Switching permitted for tool coordinates and user coordinates
- 1: Switching prohibited for tool coordinates
- 2: Switching prohibited for user coordinates
- 3: Switching prohibited for tool coordinates and user coordinates

■ S2C150: EXECUTION UNITS AT “FORWARD” OPERATION

This parameter specifies the execution units at step mode of “FORWARD” operation by the programming pendant.

Parameter Setting Value	Operation Units
0	MOVL DOUT TIMER DOUT MOVL  Stops at every instruction
1	MOVL DOUT TIMER DOUT MOVL  Stops at move instruction

■ S2C151: INSTRUCTION (EXCEPT FOR MOVE) EXECUTION AT “FORWARD” OPERATION

This parameter specifies the method of instruction (except for move) execution at “FORWARD” operation by the programming pendant.

- 0: Executed by pressing [FWD] + [INTERLOCK]
- 1: Executed by pressing [FWD] only
- 2: Instruction not executed

■ S2C155: CHANGING STEP ONLY

This parameter specifies whether to permit only step changes in an editing-prohibited job. When permitted, only position data can be changed but additional data such as speed cannot be changed. This specification can be done on the TEACHING CONDITION window.

- 0: Permitted
- 1: Prohibited

■ S2C156: MANUAL SPEED STORING FOR EACH COORDINATE

This parameter specifies whether to assign different manual speeds for the joint coordinates and other coordinates. If “NOT STORED” is selected, manual speed is not affected by changing the coordinates. If “STORED” is selected, manual speeds can be selected separately for the joint coordinates and other coordinates.

- 0: Not stored
- 1: Stored

■ S2C158: ADDITIONAL STEP POSITION

This parameter designates either “before next step” or “after the cursor position (between instructions)” as additional step position. This specification can be done on the TEACHING CONDITION window.

<Example>

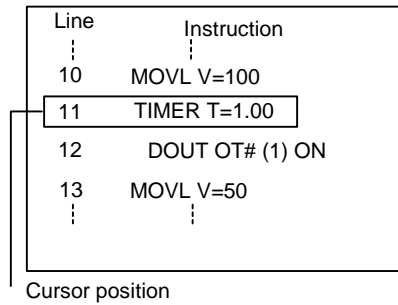

S2C158-0 (Before the Next Step)

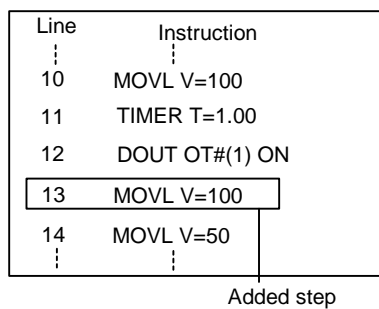

S2C158-1 (Between Instructions)

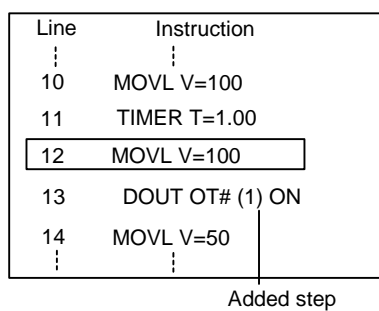

■ S2C159: MASTER JOB CHANGING OPERATION

This parameter specifies whether to permit or prohibit master job changing operation. If “PROHIBIT” is specified, the master job cannot be changed (or registered) easily. The specification can be done on the OPERATING CONDITION window.

- 0: Permitted
- 1: Prohibited

■ S2C160: CHECK AND MACHINE-LOCK KEY OPERATION IN PLAY MODE

This parameter specifies whether to permit or prohibit in play mode to change the operation that changes the operation condition. Even if an error occurs because of the operation with the keys, the manipulator does not stop. The specification can be done on the OPERATING CONDITION window.

- 0: Permitted
- 1: Prohibited

■ S2C161: RESERVED WORK JOB CHANGING OPERATION

This parameter specifies whether to permit reserved work job changing operation. The designation can be done on the OPERATING CONDITION window.

- 0: Permitted
- 1: Prohibited

■ S2C162: MASTER OR SUBMASTER CALL OPERATION IN PLAY MODE

This parameter specifies whether the master or submaster call operation in play mode is permitted or not. When the independent control function is valid, the master job for sub-task is specified at the same time. The specification can be done on the OPERATING CONDITION window.

- 0: Permitted
- 1: Prohibited

■ S2C163: LANGUAGE LEVEL

This parameter specifies the level of the robot language (INFORM III). The levels simplify the instruction registering operation. With NX100, all robot instructions can be executed regardless of specification of instruction sets. The specification can be done on the TEACHING CONDITION window.

0: Contracted Level

Only frequently used robot instructions are selected to reduce the number of instructions to be registered. Robot instructions displayed on the instruction dialog box are also reduced so that specification is simplified.

1: Standard Level

2: Expanded Level

All the robot instructions are available in standard and expanded levels. The two levels are distinguished by the number of additional information items (tags) that can be used with robot instructions. At the expanded level, the flowing functions are available.

- Local Variables and Array Variables
- Use of Variables for Tags (Example: MOVJ VJ=I000)

The above functions are not available at the standard level, however, which reduces the number of data required to register instructions, thereby simplifying the operation.

■ **S2C166: INSTRUCTION INPUT LEARNING FUNCTION**

This parameter specifies whether to set a line of instructions that has been input on the input buffer line when pressing the first soft key for each instruction. If "PROVIDED" is selected, the instructions are set.

- 0: Without learning function
- 1: With learning function

■ **S2C167: ADDRESS SETTING WHEN CONTROL POWER IS TURNED ON**

This parameter specifies the processing of the job name, step No., and line No. that are set when the control power supply is turned ON.

- 0: Reproduces the address when power supply is turned ON.
- 1: Lead address (Line"0") of the master job.

■ **S2C168: JOB LIST DISPLAY METHOD AT JOB SELECTION**

These parameters specify the displaying method on the JOB LIST window at job selection.



- 0: Order of Names
- 1: Order of Date

■ **S2C169: INITIAL OPERATION OF MANIPULATOR**

This parameter specifies the operation speed level of the first section when starting. Specify the operation speed with the low-speed start (S1CxG044). When starting at low-speed, the manipulator stops after reaching the indicated step regardless of the cycle setting. Once the manipulator is paused during the low-speed operation, it moves at teaching speed when restarted.

- 0: Specified on the SPECIAL PLAY window. Operates at low speed only when low speed start is set. Operates at taught speed when not instructed.
- 1: Starts at low speed after editing regardless of soft key instructions.

■ S2C170: PLAYBACK EXECUTION AT CYCLE MODE “1- STEP”

Parameter Setting Value	Operation Units
0	MOVL DOUT TIMER DOUT MOVL  Stops at every instruction.
1	MOVL DOUT TIMER DOUT MOVL  Stops at move instruction.



When operating “FORWARD” by the programming pendant, the units for execution are set in another parameter (S2C150).

■ S2C171: EXTERNAL START

This parameter specifies whether a start instruction from external input is accepted or not. The specification can be done on the OPERATING CONDITION window.

- 0: Permitted
- 1: Prohibited

■ S2C172: PROGRAMMING PENDANT START

This parameter specifies whether a start instruction from the programming pendant is accepted or not.

- 0: Permitted
- 1: Prohibited

■ S2C173: SPEED DATA INPUT FORM

This parameter specifies the units for speed data input and display.

- mm/s : in units of 0.1 mm/s
- cm/min : in units of 1cm/min
- inch/min : in units of 1 inch/min
- mm/min : in units of 1 mm/min

The specification can be done on the OPERATING CONDITION window.

- 0: mm/sec
- 1: cm/min
- 2: inch/min
- 3: mm/min

■ S2C174: RESERVED START

This parameter specifies whether a reserved start instruction from the programming pendant is accepted or not. The specification can be done on the OPERATING CONDITION window.

- 0: Permitted
- 1: Prohibited

■ S2C176: JOB SELECTION AT REMOTE FUNCTION (PLAY MODE)

This parameter specifies whether a job selection in play mode at remote function is prohibited or not.

- 0: Permitted
- 1: Prohibited

■ S2C177: EXTERNAL MODE SWITCH

This parameter specifies whether mode switching from the outside is accepted or not. The specification can be done on the OPERATING CONDITION window.

- 0: Permitted
- 1: Prohibited

■ S2C179: EXTERNAL CYCLE SWITCHING

This parameter specifies whether cycle switching from the outside is accepted or not. The specification can be done on the OPERATING CONDITION window.

- 0: Permitted
- 1: Prohibited

■ S2C180: PROGRAMMING PENDANT CYCLE SWITCHING

This parameter specifies whether cycle switching from the programming pendant is accepted or not. The specification can be done on the OPERATING CONDITION window.

- 0: Permitted
- 1: Prohibited

■ S2C181: SERVO ON FROM EXTERNAL PP PROHIBITION

This parameter specifies whether a servo ON instruction is accepted or not. More than one instruction can be specified. For example, to permit the servo ON instruction from an external input only, set “6.” In this case, servo ON instruction from the programming pendant is not accepted. The specification can be done on the OPERATING CONDITION window.

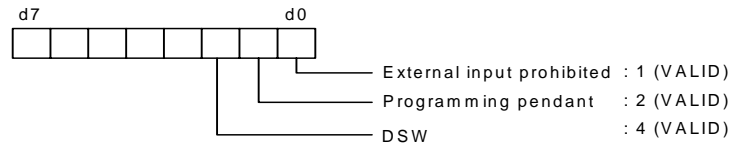

■ S2C182: PROGRAMMING PENDANT OPERATION WHEN “IO” IS SELECTED FOR REMOTE MODE

This parameter specifies whether each operation of the following is valid when “IO” is selected for remote function selection. IO and command are available for remote function selection: “IO” is set prior to shipping. “Command” is valid when transmission function (optional) is specified.

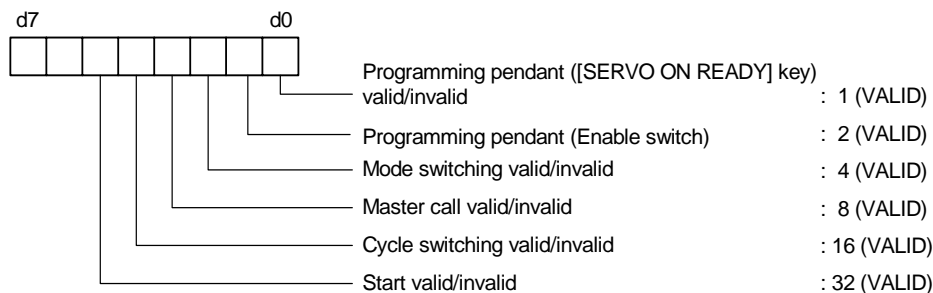

■ S2C186: STEP REGISTRATION AT TOOL NO. CHANGE

The registration of the step when the tool number is changed allows the setting to be made as prohibited.

If this parameter is set to “1” (prohibited), the following operations are prohibited.

- 0: Permitted
- 1: Prohibited

- Modification of a step
When the tool number of the teaching step differs from the currently-selected tool number, the step cannot be modified.
- Deletion of a step
Even if the teaching step position coincides with the current position, the step cannot be deleted when the tool number of the teaching step differs from the currently-selected tool number.
- Addition of a step
When the tool number of the teaching step indicated by the cursor differs from the currently-selected tool number, the step cannot be added.

■ **S2C211: REMOTE FIRST CYCLE MODE**

This parameter sets the cycle that changes from the local mode to the remote mode.
The setting can be made on the OPERATING CONDITION window.

- 0: Step
- 1: 1 cycle
- 2: Continuous
- 3: Setting retained

■ **S2C212: LOCAL FIRST CYCLE MODE**

This parameter sets the cycle that changes from the remote mode to the local mode.
The setting can be made on the OPERATING CONDITION window.

- 0: Step
- 1: 1 cycle
- 2: Continuous
- 3: Setting retained

■ **S2C230: POWER ON FIRST CYCLE MODE**

This parameter sets the first cycle mode for when the power is turned ON.
The setting can be made on the OPERATING CONDITION window.

- 0: Step
- 1: 1 cycle
- 2: Continuous
- 3: Setting retained

■ **S2C231: TEACH MODE FIRST CYCLE MODE**

This parameter sets the cycle that changes from the play mode to the teach mode.
The setting can be made on the OPERATING CONDITION window.

- 0: Step
- 1: 1 cycle
- 2: Continuous
- 3: Setting retained

■ **S2C232: PLAY MODE FIRST CYCLE MODE**

This parameter sets the cycle that changes from the teach mode to the play mode.
The setting can be made on the OPERATING CONDITION window.

- 0: Step
- 1: 1 cycle
- 2: Continuous
- 3: Setting retained

■ S2C297: SIGNAL NAME ALIAS FUNCTION

On the JOB CONTENT window, the name registered to the user input/output signal number can be displayed as alias instead of the signal number itself.

S2C297

Parameter Setting Value	Valid/Invalid
0	Function invalid
1	Function valid

With this function valid, the confirmation dialog box “Register by name (alias)?” is displayed when a signal (IN#(), OT#(), IG#(), OG#(), IGH#(), OGH#()) is selected on the DETAIL EDIT window. Select “YES” and the signal select window appears. Then select the target signal of number and press [ENTER], and the registered name is displayed instead of the signal number. However, if the signal number’s name is not yet registered, it is displayed by number as usual.

<Example> Registration of the name of user output OUT#0001 as “OUTPUT 1”

In the case of DOUT instruction:

S2C297=0 : DOUT OT#(1) ON

S2C297=1 : DOUT OT#(OUTPUT 1) ON



Select {IN/OUT} → {UNIVERSAL INPUT/OUTPUT} to edit signal names on the window. Up to 16 characters can be entered as a signal name. However, when this function is valid, if the content below is entered, the error message shows and the name cannot be registered.

- The name already registered
- Letters beginning with a number
- Letters including the signs below:
- (,) , [,] , = , < , > , space, comma
- Letters beginning with “alphabets representing variables” + “number”

<Example> B0..., I0..., BP1..., LEX2...

Alphabets representing variables: B, I, D, R, S, P, BP, EX, PX,
LB, LI LD, LR, LS, LP, LBP, LEX, LPX

When the name begins with “ ‘ ”, it is regarded as a comment and the same comment can be registered for two or more signals. In this case, although this function is valid, the number is displayed on the JOB CONTENT window instead of the name.

<Example> Registration of the name of user output OUT#0002 as “ ‘OUTPUT 2”

S2C297=0 : DOUT OT#(2) ON

S2C297=1 : DOUT OT#(2) ON

■ S2C298: VARIABLE NAME ALIAS FUNCTION

On the JOB CONTENT window, the name registered to the variable (including local variables) can be displayed as alias instead of the variable number.

S2C298	
Parameter Setting Value	Valid/Invalid
0	Function invalid
1	Function valid

With this function valid, the confirmation dialog box “Register by name (alias) ?” is displayed when you select the variable on the DETAIL EDIT window. Select “YES” and the variable select window appears. Then select the target variable of number and press [ENTER], and the registered name is displayed instead of the variable number. However, if the variable number’s name is not yet registered, it is displayed by number as usual.

<Example> Registration of the byte type variable B000 as “WORK KIND”

In the case of SET instruction

S2C298=0 : SET B000 128

S2C298=1 : SET WORK KIND 128



Select {VARIABLE} from the menu to select each variable and edit the variable name. Up to 16 characters can be entered as a variable name. However, when this function is valid, if the content below is entered, the error message shows and the name cannot be registered.

- The name already registered
- Letters beginning with a number
- Letters including the signs below:
- (,) , [,] , = , < , > , space, comma
- Letters beginning with “alphabets representing variables” + “number”

<Example> B0..., I0..., BP1..., LEX2...

Alphabets representing variables: B, I, D, R, S, P, BP, EX, PX,
LB, LI LD, LR, LS, LP, LBP, LEX, LPX

When the name begins with “ ‘ “, it is regarded as a comment and the same comment can be registered for two or more variables. In this case, although this function is valid, the number is displayed on the JOB CONTENT window instead of the name.

<Example> Registration of the byte type variable B001 as “WORKNUM”

S2C298=0 : SET B001 10

S2C298=1 : SET B001 10

■ S2C299: I/O VARIABLE CUSTOMIZE FUNCTION

This function enables registration of any particular input/output signal/variable. Reference and editing of signals/variables are possible on the same window.

S2C299

Parameter Setting Value	Valid/Invalid
0	Function Invalid
1	Function Valid

With this function valid, the sub-menu {I/O-VARIABLE CUSTOMIZE} opens under the main menu {ARC WELDING}, {SPOT WELDING}, {GENERAL}, {HANDLING} (differs by application). Select {I/O-VARIABLE CUSTOMIZE}, and the I/O-VARIABLE CUSTOMIZE window appears as shown below.

No	I/O-VARIABLE	CONTENTS	NAME
01	B001	250	BYTE001
02	#10011 OUT#0002	<input checked="" type="radio"/>	OUT0002
03	D002	123456789	DOUBLE002
04	#82015	<input type="radio"/>	CMD REMOTE SEL
05	#00010 IN#0001	SIM <input type="radio"/>	IN0001
06	I000	500	INTEGER000
07			
08			
09			
10			
11			
12			

I/O-VARIABLE CUSTOMIZE Window

On the I/O-VARIABLE CUSTOMIZE window, any of the input/output signals/variables can be selected and registered (up to 32 items). Registrable signals/variables are as follows:

Registrable Items on the I/O-VARIABLE CUSTOMIZE Window

Input/Output Signals	USER INPUT SIGNAL USER OUTPUT SIGNAL PSEUDO INPUT SIGNAL
Variables	BYTE TYPE VARIABLE (B VARIABLE) INTEGER TYPE VARIABLE (I VARIABLE) DOUBLE-PRECISION INTEGER TYPE VARIABLE (D VARIABLE)

The contents and names of the registered signals/variables can be checked and edited on this window.

In addition, the data list of registered signals/variables can be loaded, saved, verified or deleted with an external memory unit.

Only when this function is valid, "I/O-VARIABLE CUSTOMIZE (file name: USRIOVAR.DAT)" is displayed and can be selected. To display the "I/O-VARIABLE CUSTOMIZE (file name: USRIOVAR.DAT)", select {FD/CF} → {LOAD} {SAVE} {VERIFY} {DELETE} → {SYSTEM DATA}

■ **S2C317 to S2C321: TIME RESET**

These parameters specify whether resetting operation of the specified times is permitted or not.

S2C317 : CONTROL POWER ON TIME

S2C318 : SERVO POWER ON TIME

S2C319 : PLAYBACK TIME

S2C320 : WORK TIME

S2C321 : WEAVING TIME

0: Prohibit Resetting

1: Permit Resetting

“PERMIT” is set as the initial value for the work time and motion time.

■ **S2C333: TOOL NO. SWITCHING**

This parameter specifies whether tool number switching is permitted or not. If “PERMIT” is selected, 24 types of tools from number 0 to 23 can be switched. If “NOT PERMIT” is selected, only number “0” can be used.

0: Prohibited

1: Permitted

■ **S2C335: POSITION TEACHING BUZZER**

This parameter specifies whether the buzzer sound at position teaching is used or not.

0: With buzzer

1: Without buzzer

■ S2C336: JOB LINKING DESIGNATION (When Twin Synchronous Function Used)

This parameter specifies whether the manipulator at the synchronizing side is to be linked when the manipulator and the station at the synchronized side are performing FWD/BWD or test run, by using the twin synchronous function.

0: Not operating

1: Linking

0 : Does not operate the synchronizing side while teaching the synchronized side.

1 : Links the synchronizing side while teaching the synchronized side.

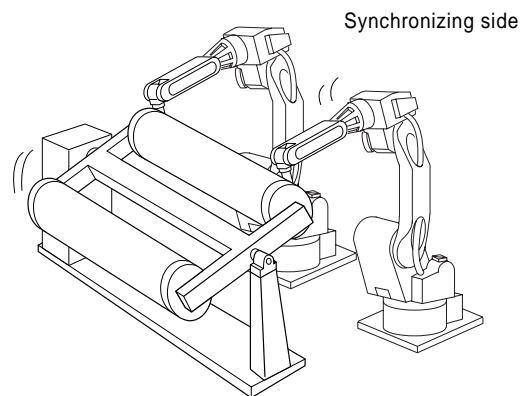
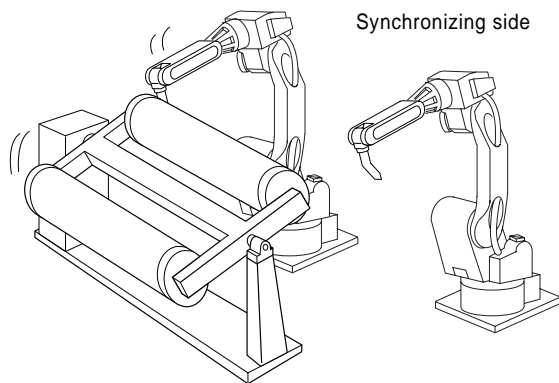

■ S2C339: PLAYBACK OPERATION CONTINUATION FUNCTION

This function is used to decide where to resume the playback on the start operation after suspending the playback and moving the cursor or selecting other jobs.

- 0: Starts operation where the cursor is located in the job displayed at the moment.
- 1: The playback continuation window appears. Select “YES” and the playback resumes where the cursor has been located when the playback suspended. If “NO” is selected, the playback resumes where the cursor is located in the job displayed at the moment.

S2C339

Parameter Setting Value	Where the Playback Resumes
0	Resumes where the cursor is located in the job displayed at the moment.
1	Resumes where the cursor has been located when the playback suspended OR where the cursor is located in the job displayed at the moment. <Example> Suspended at step 0003 during the playback of job A ↓ Displays job B ↓ Starts operation ↓ On the playback operation continuation window <ul style="list-style-type: none"> • When “YES” selected, the playback resumes from step 0003 of job A • When “NO” selected, the playback resumes from the current position in job B

* When this function is valid (S2C339=1), a light blue cursor is displayed at the instruction section of step where the playback has been stopped. When “YES” is selected, the playback resumes where this cursor is located.

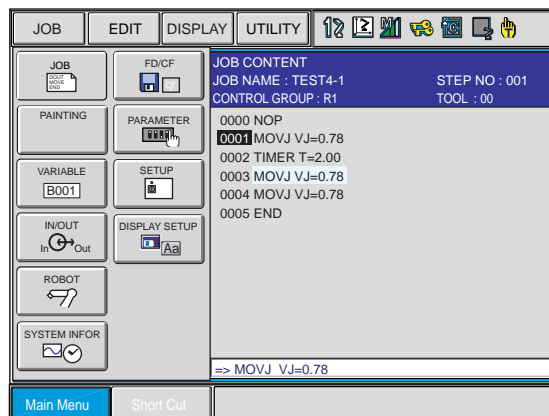

NOTE If a job has been edited or FWD/BWD/TEST RUN operation(s) have been executed, the playback cannot resume where it has suspended. Also this function is invalid if the reserved start function is set valid (S2C174=0).

8.4 Parameters according to Interference Area

These parameters limit the P-point maximum envelope of the manipulator or set the interference area for axis interference or cubic interference.

■ S1CxG200 to S1CxG215: PULSE SOFT LIMIT

Soft limit is set independently for each axis by pulse value setting. Set current value (pulse value) of the axis at the soft limit set up position.

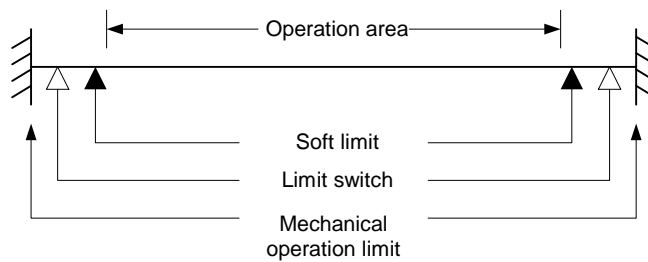

■ S2C001: CUBE SOFT LIMIT CHECK

This parameter specifies whether to check the cube soft limit. More than one soft limit can be specified.

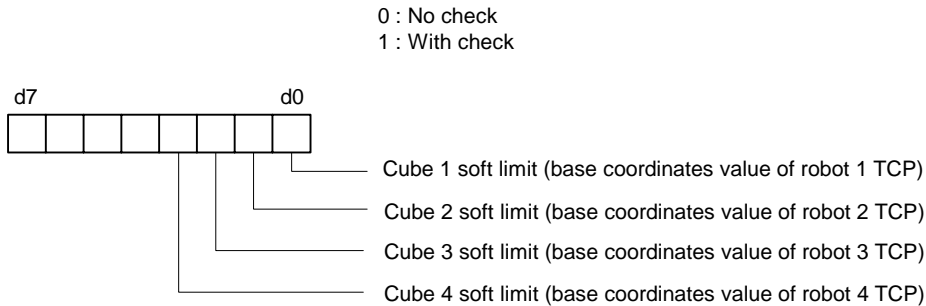

If "WITH CHECK" is selected, set up the following parameters.

S3C000 to S3C023: Cube Soft Limit



Soft Limit

Soft limit is a software-type function to limit the range of movement of the manipulator. If the TCP reaches the soft limit during operation, the manipulator automatically stops and no longer moves in that same direction. An alarm occurs if this soft limit is exceeded during playback. This soft limit is classified into two types.

- Cube Soft Limit

Soft limit is set with the absolute value on the base coordinates.

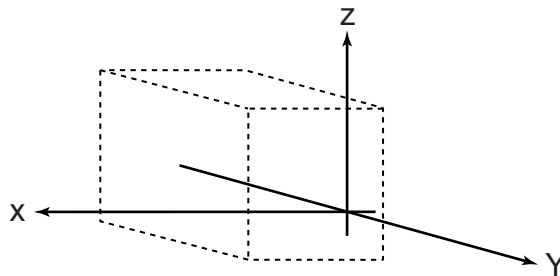

- Pulse Soft Limit (Independent Axis Soft Limit)

Refer to " S1CxG200 to S1CxG215: PULSE SOFT LIMIT. "

■ S2C002: S-AXIS INTERFERENCE CHECK

This parameter specifies whether to check for interference with each manipulator. If "WITH CHECK" is selected, set up the following parameters.

S3C024 to S3C031: S-axis Interference Area

■ S2C003 to S2C050: CUBE/AXIS INTERFERENCE CHECK

1. Designation of checking

These parameters specify the cube/axis interference to be used by bit.

0 : Cube Interference/Axis Interference Not Used

1 : Robot 1

2 : Robot 2

3 : Robot 3

4: Robot 4

5 : Base Axis 1

6 : Base Axis 2

7 : Base Axis 3

8: Base Axis 4

9 : Station Axis 1

10 : Station Axis 2

11 : Station Axis 3

12: Station Axis 4

13 : Station Axis 5

14: Station Axis 6

15: Station Axis 7

16: Station Axis 8

17 : Station Axis 9

18: Station Axis 10

19: Station Axis 11

20: Station Axis 12

2. Checking method

Designates whether checking is performed by command or feedback.

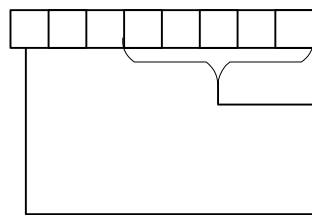

Designation of checking (data setting)

0: Not used

1: Robot 1, ----, 20: Station axis 12

Checking method (bit setting)

0: Command, 1: Feedback



Checking method

The checking method differs according to ON/OFF status of servo power supply.

Checking Method Designation	Servo Power Supply ON	Servo Power Supply OFF
Command	Command	Feedback
Feedback	Feedback	Feedback

During the servo float function operation, checking is performed by feedback regardless of the checking method designation.



Interference Area

It is possible to output whether the TCP during operation is inside or outside as a status signal, and to set the area to control the position by parameters S2C003 to S2C114. When the manipulator attempts to enter this area, the corresponding input signal (e.g. an “entrance prohibit signal”) is detected. The manipulator stops immediately if there is an input signal and goes into waiting status until this signal is cleared. This signal is processed in the I/O section. Three methods of interference area settings are prepared for manipulators and stations. For a system with one manipulator, use robot 1.

• **S-axis Interference Area**

Position is controlled by the pulse value of the S-axis.

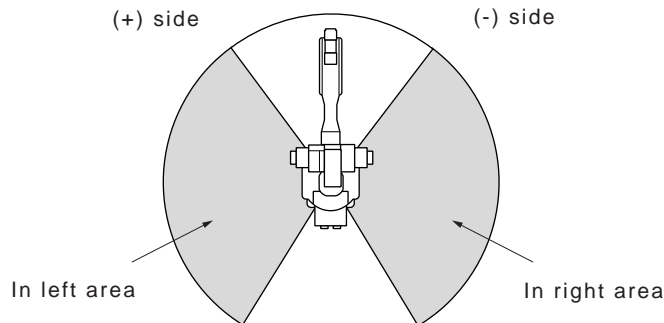

• **Cubic Interference Area**

Up to 32 cubic areas can be set. The edges of the cubes are set parallel to the robot coordinates or the user coordinates.

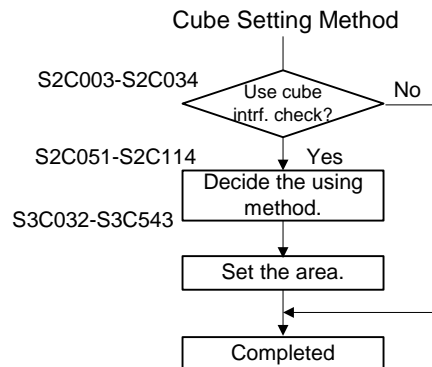
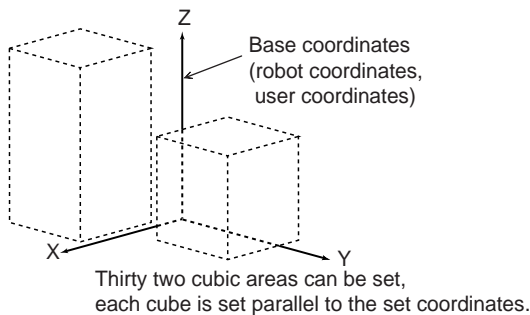

• **Axis Interference Area**

Up to 32 areas can be set. Each operation area maximum and minimum value are set for the robot, base axis, and station axis plus and minus side.

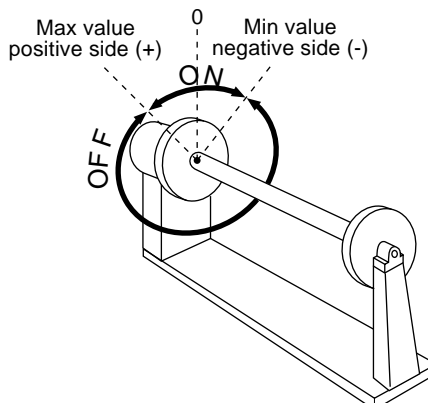

■ S2C051 to S2C114: CUBE USING METHOD

These parameters specify the coordinates for defining the cube. If the user coordinates are selected, also specify the user coordinate system numbers. Set cubic area referring to the cubic interference areas shown below.

Coordinate specification

- 0 : Pulse (axis interference)
- 1 : Base coordinates
- 2 : Robot coordinates
- 3 : User coordinates

Coordinate No.: Specify the user coordinate number when selecting "3: User Coordinates."

Units: 1 μ m



Precaution When Setting the Interference Area

It will be necessary to consider the following when setting the cubic interference and S-axis interference areas. The manipulator is processed to decelerate to stop from the point where it enters in the area. Therefore, set the areas in consideration of the amount of the manipulator movement in the deceleration section shown in the figure below.

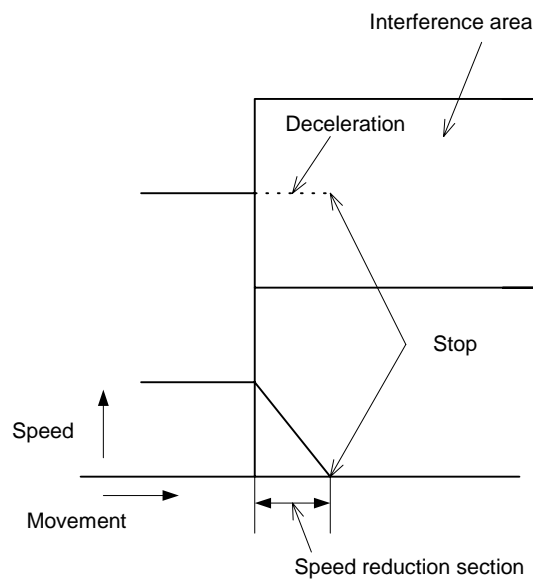

The move amount in the speed reduction section is dependent on the moving speed of the manipulator at that time:

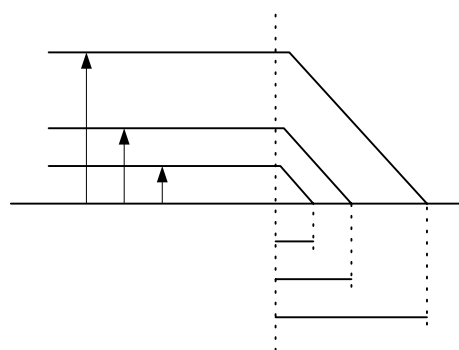

$V = 1500\text{mm/s} \rightarrow$ approx. 300mm (Max.)

$V = 1000\text{mm/s} \rightarrow$ approx. 160mm

$V = 30\text{mm/s} \rightarrow$ approx. 3 to 4 mm

$V = 20\text{mm/s} \rightarrow$ approx. 2mm



Interference Prevention in Interference Area

Processing to prevent interference is executed in the I/O processing section. The relation between the NX100 I/O signal and manipulator operation is shown below.

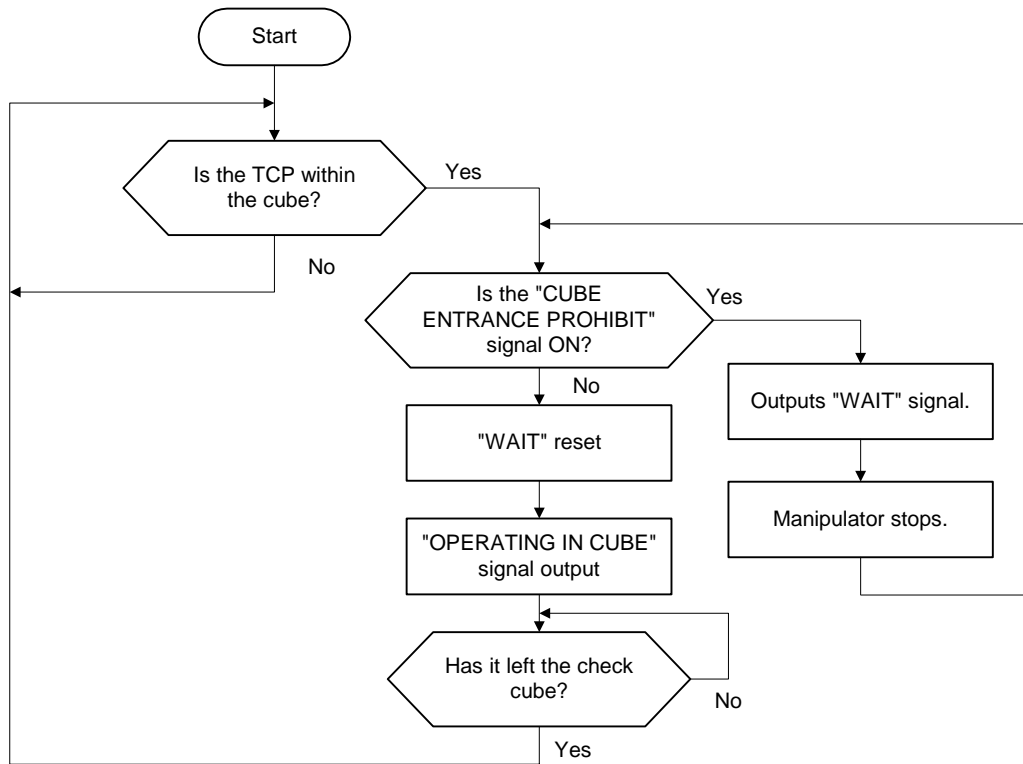

In wait status with the entrance prohibit signal, the manipulator just barely enters the area for speed reduction processing and then stops.

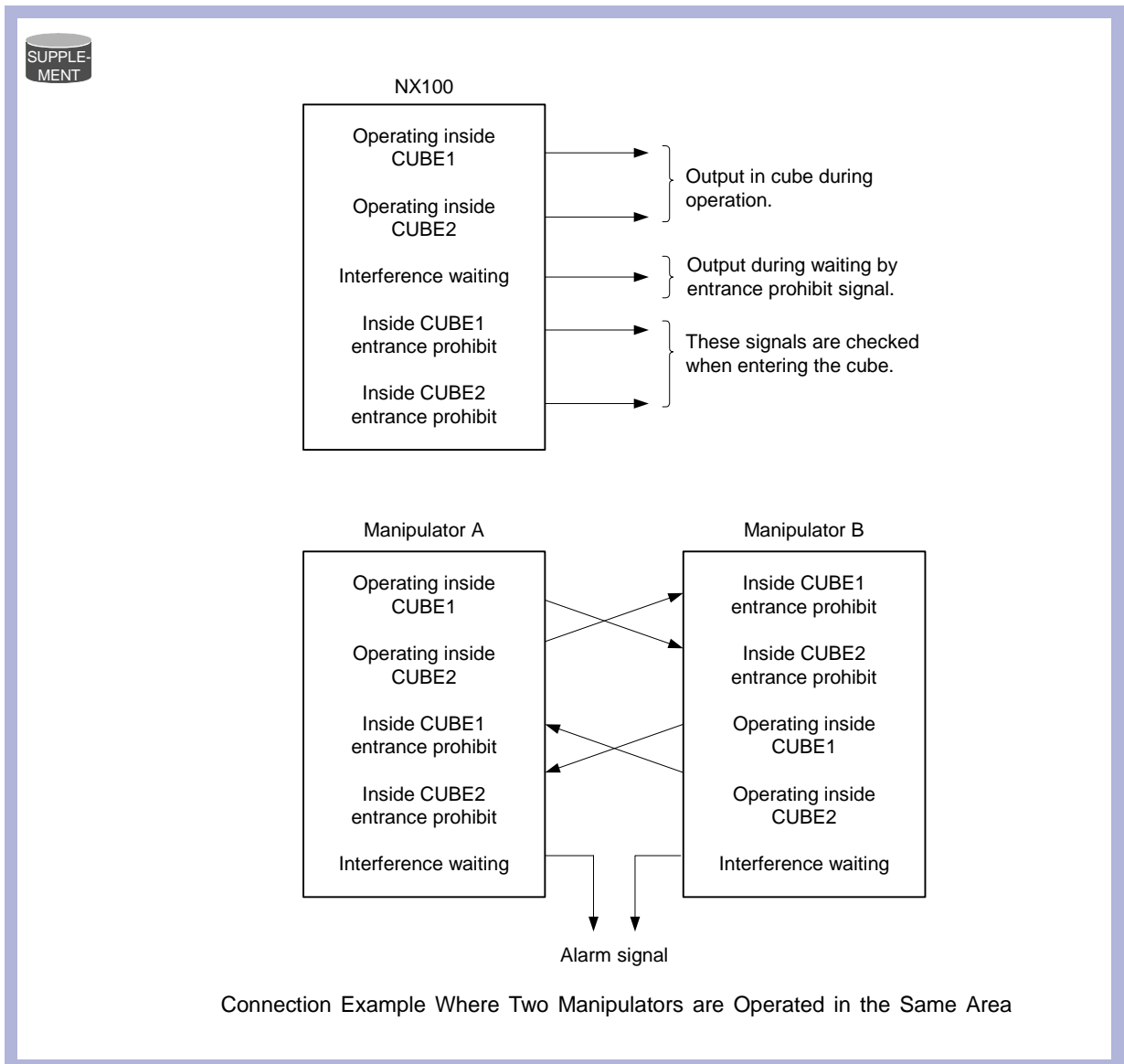

■ S2C188 to S2C193: ROBOT INTERFERENCE CHECK

This parameter specifies whether to check interference between robots 1, 2, 3, and 4. Interference check is executed in the spherical range having the TCP in the center. If “provided” is selected, also select the following parameters.

ROBOT INTERFERENCE CHECK (units: μm)

S3C801 : ROBOT1 SPHERE RADIUS

S3C802 : ROBOT2 SPHERE RADIUS

S3C803 : ROBOT3 SPHERE RADIUS

S3C804 : ROBOT4 SPHERE RADIUS

■ S3C000 to S3C023: CUBE SOFT LIMIT

These parameters specify auxiliary functions of S2C001 parameter. For details, see the explanation of the S2C001 parameter.

■ **S3C024 to S3C031: S-AXIS INTERFERENCE AREA**

These parameters specify auxiliary functions of S2C002 parameter. For details, see the explanation of the S2C002 parameter.

■ **S3C032 to S3C543: CUBIC INTERFERENCE AREA**

These parameters specify auxiliary functions of S2C003 to S2C034 parameters. For details, see the explanation of the S2C003 to S2C050 parameters.

■ **S3C801 to S3C804: ROBOT INTERFERENCE AREA**

These parameters specify auxiliary functions of S2C188 to S2C193 parameters. For details, see the explanation of the S2C188 to S2C193 parameters.

■ **S3C805: A SIDE LENGTH OF WORK-HOME-POSITION CUBE**

Units: 1 μ m

This parameter specifies a side length of the cube for the work home position.

8.5 Parameters according to Status I/O

These parameters set the parity check or I/O setting for user input/output signals.

■ **S2C187: USER OUTPUT RELAY WHEN CONTROL POWER IS ON**

This parameter specifies the state of the user output relays when the control power is turned ON. Since the power OFF state, including peripheral devices, cannot be completely reproduced, take note when restarting.

- 0: Reset to the power OFF state
- 1: Initialized (all user relays OFF)

■ S4C000 to S4C007: PARITY OF USER INPUT GROUPS

These parameters specify whether to execute priority checks with parameters when instructions covering the input group (1G#) are executed. The instructions covering the input groups are as shown below.

- IF Sentence (JUMP, CALL, RET, PAUSE)
- Pattern Jump, Pattern Job Call
- DIN
- WAIT

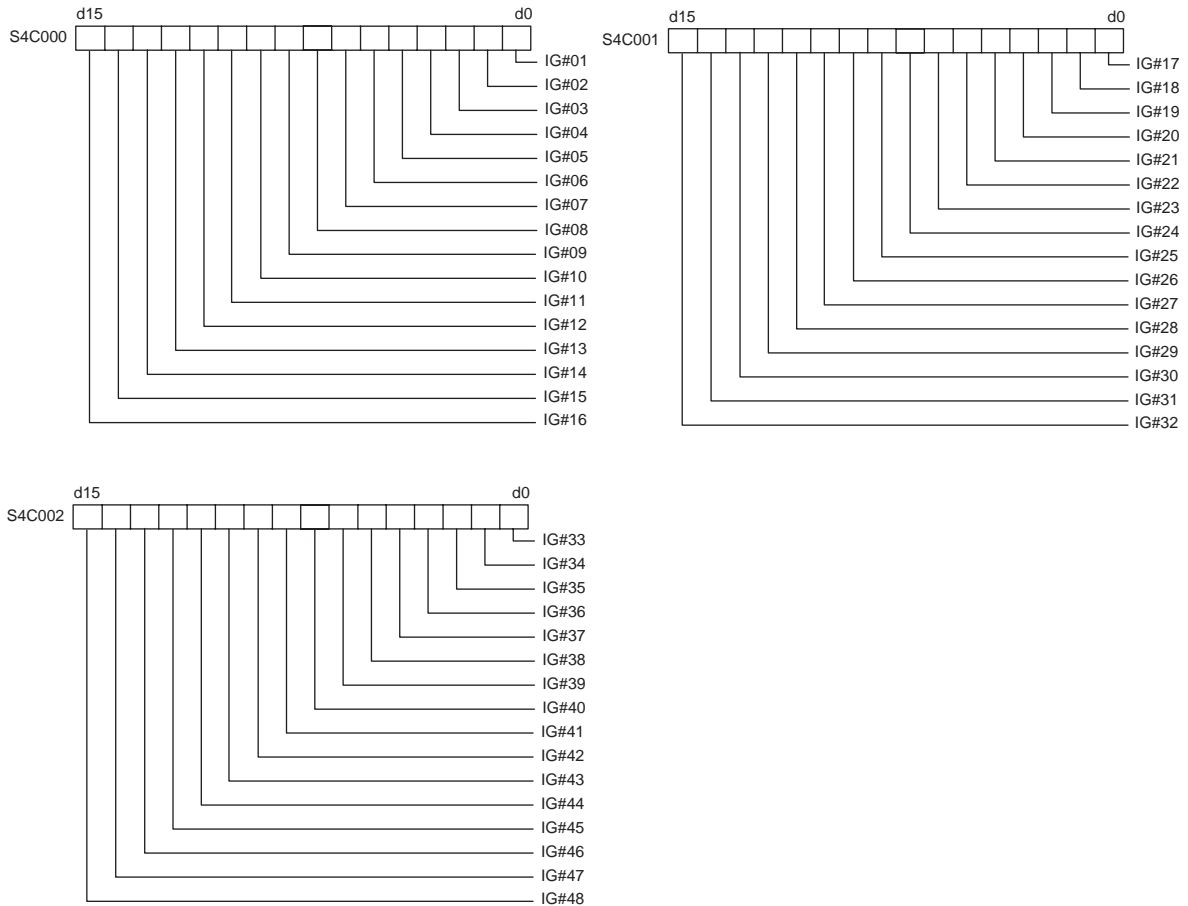

Parity bits are set as the highest level bits of each input group and are written in even parity. If an error is detected during parity check, an alarm occurs and the manipulator stops. Remains unchanged if no parity check is specified.

■ S4C008 to S4C015: PARITY OF USER OUTPUT GROUPS

These parameters specify whether the output group instruction is executed with parity check (even parity).

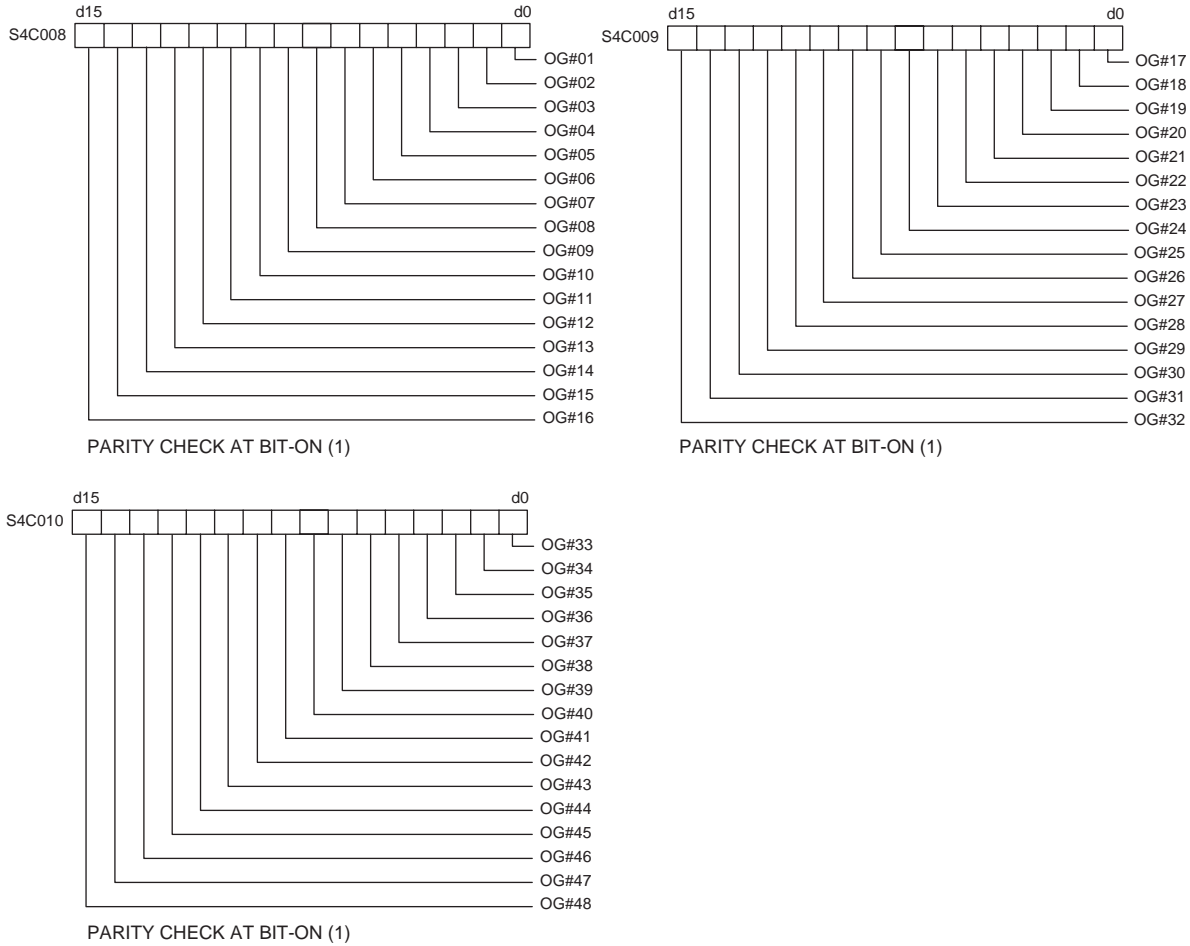

Parity bits are set as the highest level bits of each output group. For example, if OG#01 is specified with parity and DOUT OG# (1) 2 is executed, the result will be 00000010 if 2 is binary converted. Since there will be only one bit (odd) ON at this time, the parity bit (highest level bit) will be set to ON and 10000010 (130) will be output to OG# (1).

As in the case of a variable such as DOUT OG# (1) B003 parity bits are added to the contents of the variable data. However, if the contents of the variable exceed 127, as in the case of DOUT OG# (1) 128, an alarm will occur. Remains unchanged if no parity check is specified.

■ S4C016 to S4C023: DATA OF USER INPUT GROUPS

These parameters specify whether to handle the input group data as binary data or as BCD data when an instruction for the input group (1G#) is executed. The instructions covering the input groups are as shown below.

- IF Sentence (JUMP, CALL, RET, PAUSE)
- Pattern Jump, Pattern Job Call
- DIN
- WAIT

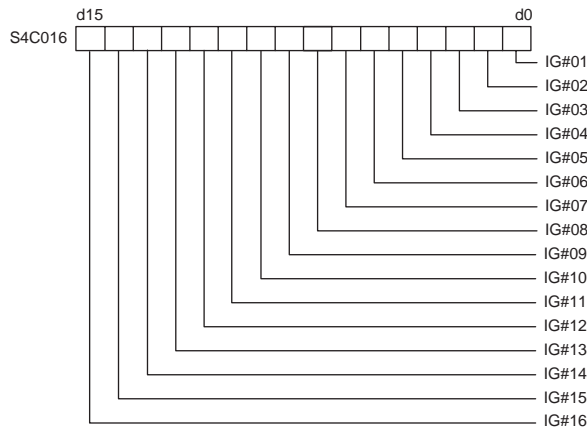

BCD DATA SPECIFICATION AT BIT-ON (1)

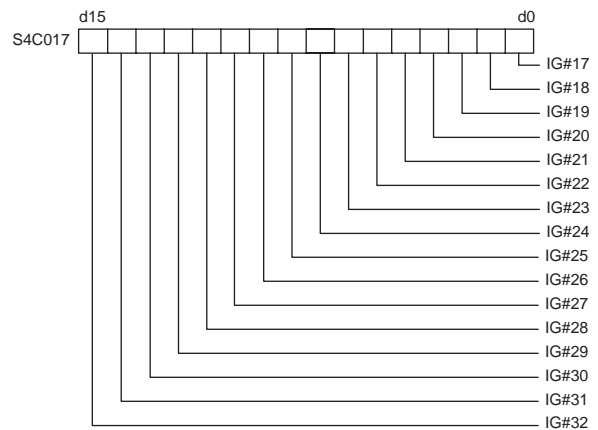

BCD DATA SPECIFICATION AT BIT-ON (1)

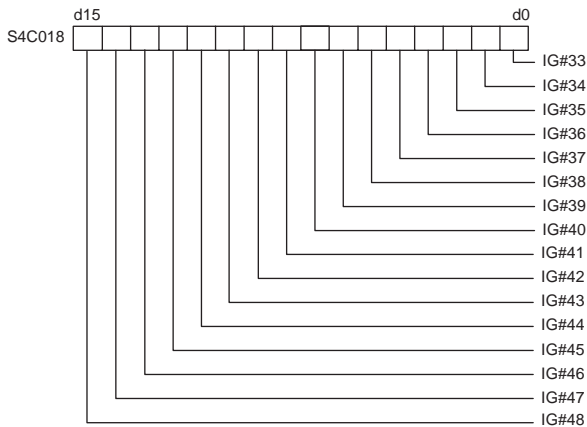

BCD DATA SPECIFICATION AT BIT-ON (1)

■ S4C024 to S4C031: DATA OF USER OUTPUT GROUPS

These parameters specify whether the output group instruction is executed with binary data or BCD data.

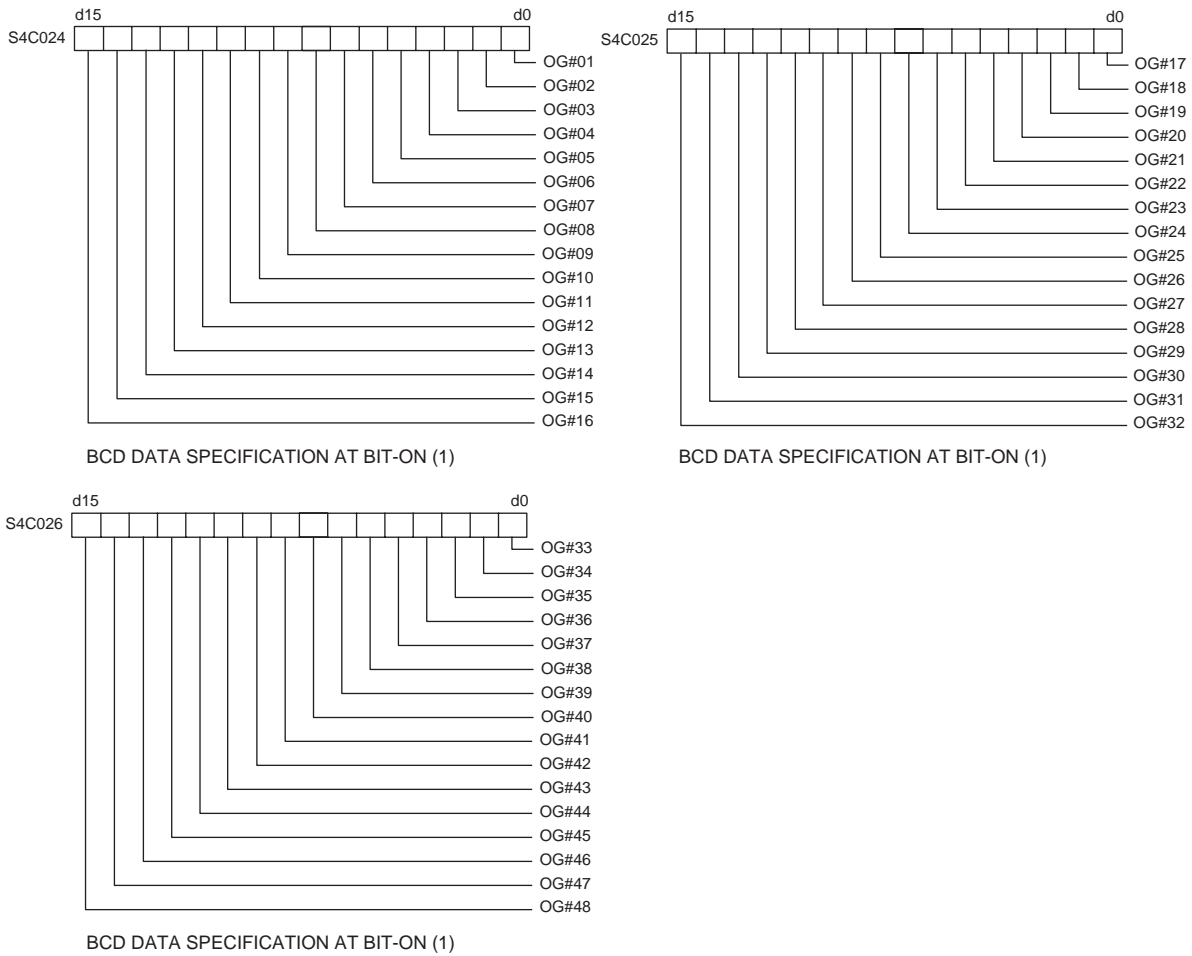

Differences Between Binary Data and BCD Data

For the input group and output group, the result will depend on whether the binary or BCD formula is used.

<Example> When the input function is [10101010]

DATA		EDIT	DISPLAY
USER INPUT GROUP		IG#01	
IN#0001	#10010	<input checked="" type="checkbox"/>	
IN#0002	#10011	<input type="checkbox"/>	
IN#0003	#10012	<input checked="" type="checkbox"/>	
IN#0004	#10013	<input type="checkbox"/>	
IN#0005	#10014	<input checked="" type="checkbox"/>	
IN#0006	#10015	<input type="checkbox"/>	
IN#0007	#10016	<input checked="" type="checkbox"/>	
IN#0008	#10017	<input type="checkbox"/>	

➔

State	Binary	BCD	
		Case	Case
1	$2^0 = 1$	1	$2^0 = 1$
0	$2^1 = 2$	0	$2^1 = 2$
1	$2^2 = 4$	4	$2^2 = 4$
0	$2^3 = 8$	0	$2^3 = 8$
1	$2^4 = 16$	16	$2^0 = 1$
0	$2^5 = 32$	0	$2^1 = 2$
1	$2^6 = 64$	64	$2^2 = 4$
0	$2^7 = 128$	0	$2^3 = 8$
		85	55

Binary data value BCD data value

However, in the case of BCD data, because the upper bound value is 99, it is not possible to use any value which exceeds nine in the one or ten digit place.

■ S4C032 to S4C039: USER OUTPUT GROUP TO BE INITIALIZED AT SWITCHING MODE

Set the user output group with bit to be initialized at switching mode. Use these parameters when using user output signals as work instructions for peripheral devices.

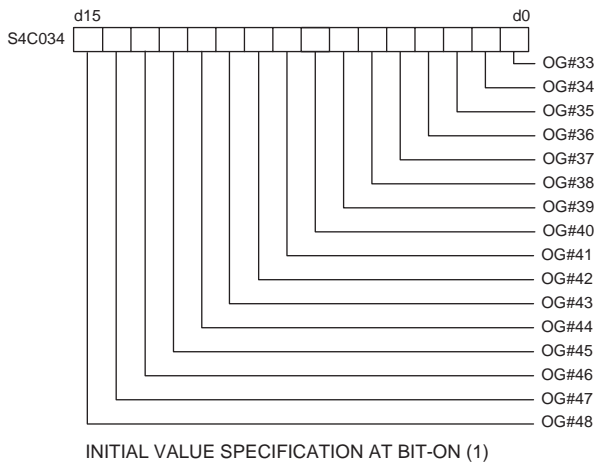
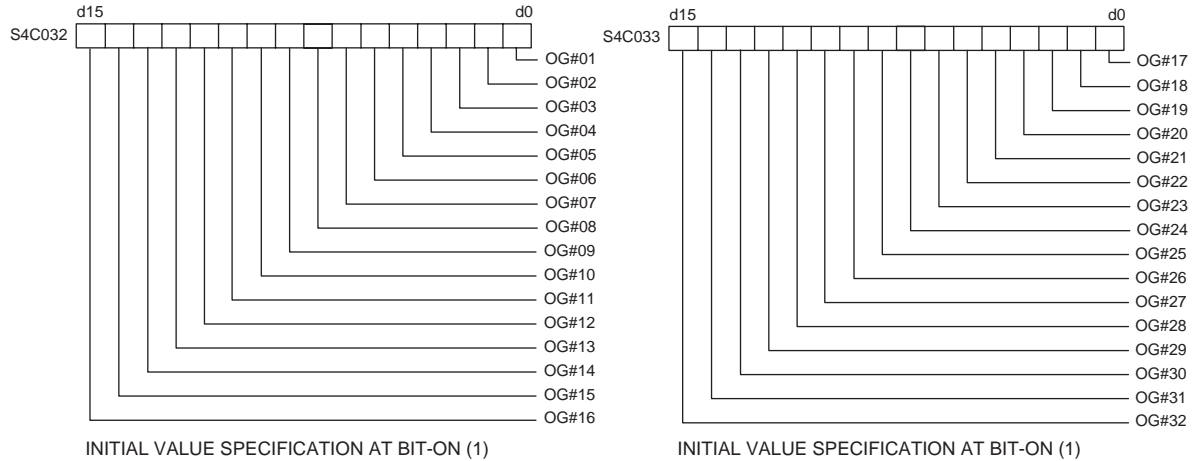

■ S4C126: USER OUTPUT NO. WHEN MANIPULATOR DROP ALLOWABLE RANGE ERROR OCCURS

This parameter specifies the user output number to output the manipulator drop allowable range error alarm occurrence externally. When this function is not used, set "0."

8.6 Parameters according to Coordinated or Synchronized Operation

These parameters make the settings for coordinated or synchronized operations between manipulators or between manipulators and stations.

■ S2C164: +MOV or +SMOV INSTRUCTION SPEED INPUT

This parameter specifies whether the speed inputting for move instructions of the master robot in a coordinated job is permitted or not.

<Example> 0: Not Provided

1: Provided

SMOVL V=100

SMOV L V=100

+MOVL ← Master side

+MOV L V=100 ← Master side

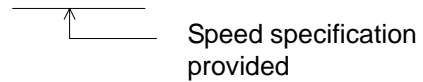
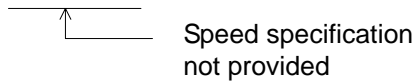

■ S2C165: +MOV INSTRUCTION INTERPOLATION INPUT

This parameter specifies which interpolation is permitted for move instructions for the master robot in a coordinated job. More than one instruction can be specified.

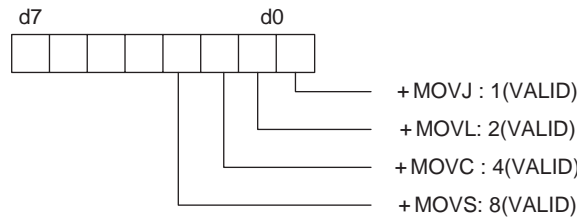

■ S2C183: OPERATION METHOD AT FWD/BWD OPERATION OR TEST RUN BY INDEPENDENT CONTROL

This parameter specifies the operation method at FWD/BWD operation or test run by independent control.

0: The job of the task that is currently displayed operates.

1: Jobs of all the tasks operate.

① When master task is currently displayed:

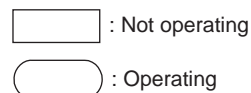
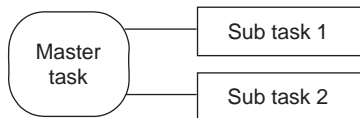

② When sub task 1 is currently displayed:

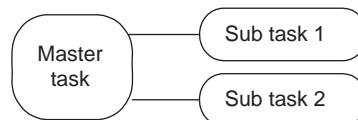
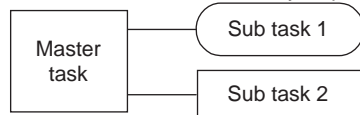

③ When sub task 2 is currently displayed:

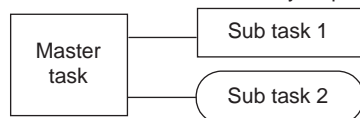

0: One of the task jobs that are currently displayed operates.

1: All task jobs operate.

■ S2C184: JOB AT CALLING MASTER OF SUBTASK 1, 2, 3, 4, 5, 6, 7 BY INDEPENDENT CONTROL

This parameter specifies the job which is called up when the master of the subtask is called up by independent control.

- 0: Master job
- 1: Root job

Master Job: Job registered in the master control window

Root Job: Job activated by PSTART instruction

■ S2C194: STATION AXIS CURRENT VALUE DISPLAY FUNCTION

This parameter specifies whether the function to display the current value of the station axis in the following units is valid/invalid.

- Rotary axis : Angle (deg)
- Servo track : Distance (mm)

- 0: Invalid
- 1: Valid

■ S2C195 to S2C206: STATION AXIS DISPLAYED UNIT

This parameter specifies the station axis displayed unit (bit specification).

- 0: Display angle (deg)
- 1: Display in distance (mm)

Setting Method

Set a numerical value (decimal) where the bit of the axis to be displayed in the units of distance becomes 1.

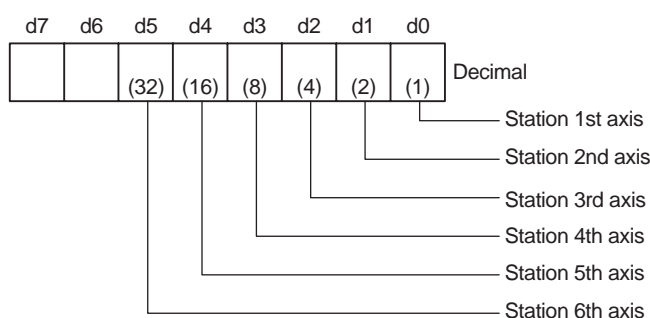

<Example> When 1st and 3rd axes of station 1 are displayed in the units of distance:

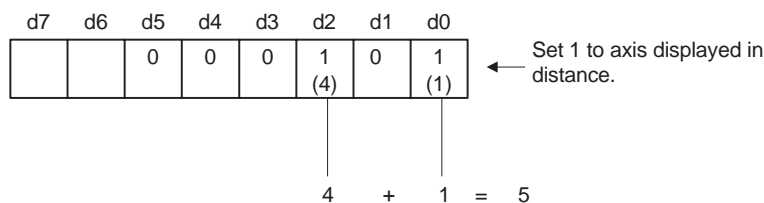

Therefore, set parameter S2C195 of station 1 to 5.

■ S2C322: POSTURE CONTROL OF SYNCHRONIZED MANIPULATOR (When Twin Synchronous Function Used)

This parameter specifies the posture control method for synchronized manipulator performing compensation during playback by using the twin synchronous function.

- 0: Change posture according to station movement
- 1: Fixed in relation to the ground

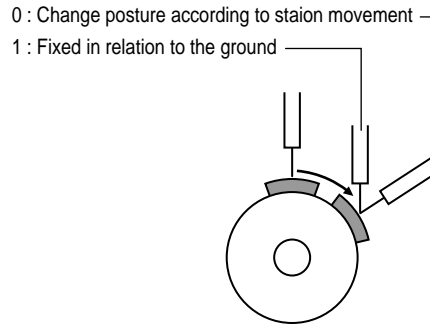

■ S2C323: POSTURE CONTROL OF MANIPULATOR IN MULTI-JOB (When Twin Synchronous Function Used)

This parameter specifies the posture control method for manipulator executing compensation at the linking side when job linking is performed during FWD/BWD operation by the twin synchronous function.

- 0: Change posture according to station movement
- 1: Fixed in relation to the ground

■ S2C549: OPERATION OF JOB WITHOUT CONTROL GROUP SPECIFICATION

When the servo power supply is individually turned OFF where jobs in multiple number of tasks are operated using the independent control function, the job execution of the control group whose servo power supply is turned OFF is interrupted. The jobs of other control groups continue their execution.

For the jobs without control group specification such as master job, the conditions for execution can be set by the parameter.

- 0: Execution possible only when servo power supply to all the axes have been turned ON.
- 1: Execution possible when servo power supply to any axis is turned ON.

■ S2C550: EXECUTION OF “BWD” OPERATION

This parameter prohibits step-back operation of a job without a step.

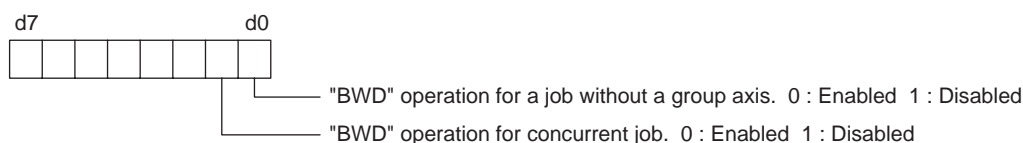

■ S3C809: MAXIMUM DEVIATION ANGLE OF CURRENT STATION POSITION (When Twin Synchronous Function Used)

Used when the twin synchronous function is used. This parameter specifies the maximum deviation between the teaching position and the current station position.

- 0 : No deviation check
- Other than 0: Deviation angle (units : 0.1°)

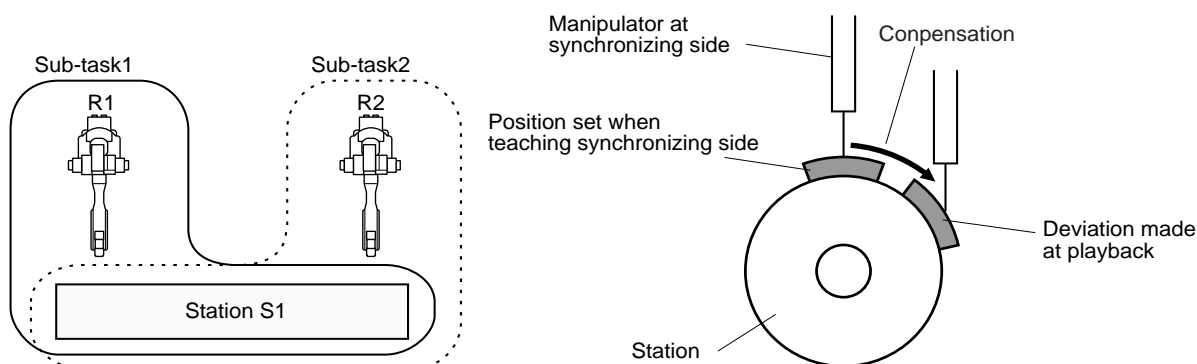

In the above figure on the left, the follower R2 executes the job of subtask 2 in synchronization with the motion of the station axis which is moved by the R1 job. In this procedure, the job of subtask 2 controls only the R2 robot axis.

If the teaching position of the station in the subtask 2 differs from the station current position (controlled by the subtask 1 job), the difference is automatically offset so that R2 keeps the taught position in relation to the station.

Difference between the taught and the station current positions is always monitored. If the difference exceeds a set value of the parameter, the message “PULSE LIMIT (TWIN COORDINATED)” appears.

8.7 Parameters for Other Functions or Applications

These parameters make the settings for other functions or applications.

■ S1CxG049 to S1CxG051: SMALL CIRCLE CUTTING

These parameters prescribe cutting operation at small circle cutting.

- S1CxG049 : Set the minimum diameter of a figure in the units of μm that can (Minimum diameter) be processed by small-circle cutting machine.
- S1CxG050 : Set the maximum diameter of a figure in the units of μm that can (Maximum diameter) be processed by small-circle cutting machine.
- S1CxG051 : Set the maximum cutting speed at operation by CUT instruction (Maximum speed) in the units of 0.1mm/s.

■ S1CxG052 to S1CxG053: SMALL CIRCLE CUTTING DIRECTION LIMIT VALUE

These parameters set the cutting direction limits at small circle cutting.

- S1CxG052 : Set the limit value in the positive direction of cutting angle DIR (+ direction) set by CUT instruction, in the units of 0.01° .
- S1CxG053 : Set the limit value in the negative direction of cutting angle DIR (- direction) set by CUT instruction, in the units of 0.01° .

■ S1CxG054 to S1CxG055: SMALL CIRCLE CUTTING OVERLAP VALUE

These parameters set the overlapped value at small circle cutting.

- S1CxG054 : Set the operation radius at inner rotation in the units of 1 μm after (Operation radius) overlapping by CUT instruction.
- S1CxG055 : Set the rotation angle at inner rotation in the units of 0.1° after (Rotation angle) overlapping by CUT instruction.

■ S1CxG063, S1CxG064: PATTERN CUTTING DIMENSION

These parameters set the minimum diameter (S1CxG063) and the maximum diameter (S1CxG064) for the pattern cutting in units of μm .

■ S1CxG065: MIRROR SHIFT SIGN INVERSION

This parameter sets which axis to be shifted (mirror-shift: invert the sign).

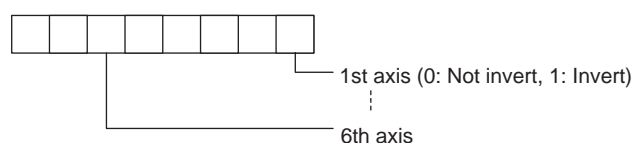

■ S2C332: RELATIVE JOB OPERATION METHOD

This parameter specifies how to operate a relative job. A method to convert a relative job into a standard job (pulse), and a conversion method to calculate the aimed position (pulse position) when a relative job is operated can be specified.

- 0: Previous step with priority (B-axis moving distance minimized.)
- 1: Form with priority
- 2 Previous step with priority (R-axis moving distance minimized.)

■ S3C819 to S3C898: ANALOG OUTPUT FILTER CONSTANT (When analog output corresponding to speed function is used)

By setting a constant to filter, a filter processing can be performed for the output analog signal.

■ S3C899: CUT WIDTH CORRECTION VALUE (When form cutting function is used)

This parameter specifies the path correction value for pattern cutting operation. A value 1/2 of the cut width is set in units of μm .

8.8 Hardware Control Parameters

These parameters make the hardware settings for fan alarm or relay operation, etc.

■ S2C508: ANTICIPATOR FUNCTION

This parameter specifies anticipation output.

- 0: Invalid
- 1: Valid

The anticipator function is a function to quicken or slow the ON/OFF timing of four user output signals and two user output groups. Using this function, signal output can be carried out before or after the step is reached. As a result, timing deviation due to delayed motion of peripheral devices and robot motion can be adjusted.

Setting the time to a negative value (-) advances the signal output.

This setting is effective when adjusting timing deviation due to delayed motion of peripheral devices.

Setting the time to a positive value (+) delays the signal output.

This setting is effective when adjusting timing deviation due to delayed robot motion.

<Advanced Signal Output>

Signal output is carried out before the step is reached.

Step	Instructions
:	:
n-1	MOVL
n	MOVL NWAIT ANTOUT AT#(1) ON
n+1	MOVL

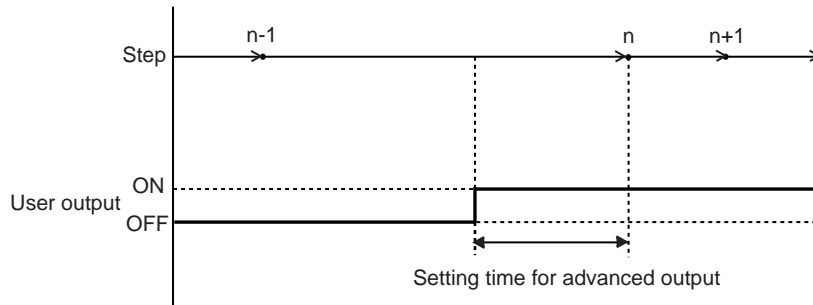

<Delayed Signal Output>

Signal output is carried out after the step is reached.

Step	Instructions
:	:
n-1	MOVL
n	MOVL NWAIT ANTOUT AT#(2) ON
n+1	MOVL

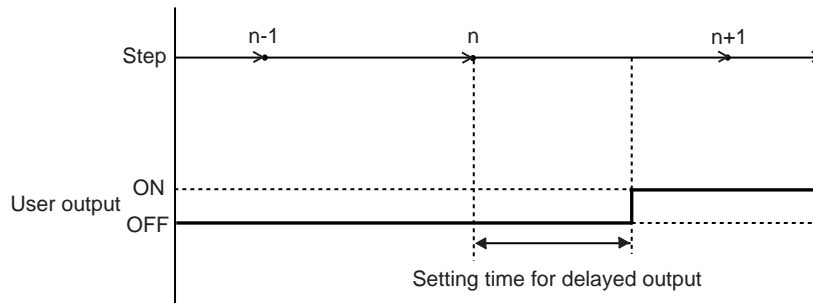

■ S2C646 to S2C648: COOLING FAN ALARM DETECTION

This parameter specifies a detection for cooling fan 1 to 3 with alarm sensor, connected to power ON unit.

- 0: No detection
- 1: Detected with message display
- 2: Detected with message and alarm display

■ S4C181 to S4C212: SETTING OF OPERATING RELAY NO.

Up to 32 output signals can be turned ON/OFF with the programming pendant. The object relay No. is set in these parameters. Although it is possible to set optional values for output No. 1 to 1024 in the parameters, the following must be taken into consideration.

- Avoid setting duplicate numbers.
- The signal turned ON or OFF with the programming pendant is operated again or remains unchanged until the instruction is executed.

■ S4C213 to S4C244: OPERATING METHOD OF RELAYS

These parameters specify the operating method of output signals by the programming pendant. The operating method can be specified for each output signal.

Parameter Setting Value	Operation of Output Signal
0	<div style="display: flex; align-items: center; margin-bottom: 5px;"> <div style="border: 1px solid black; padding: 2px; margin-right: 5px;">+ON</div> <div style="margin-right: 10px;"> </div> </div> <div style="display: flex; align-items: center;"> <div style="border: 1px solid black; padding: 2px; margin-right: 5px;">-OFF</div> <div style="margin-right: 10px;"> </div> </div>
1	<div style="display: flex; align-items: center; margin-bottom: 5px;"> <div style="border: 1px solid black; padding: 2px; margin-right: 5px;">+ON</div> <div style="margin-right: 10px;"> ON/OFF with the key ON while the key is pressed </div> <div style="margin-left: 20px;"> </div> </div> <div style="display: flex; align-items: center;"> <div style="margin-right: 10px;"> OFF if the key is not pressed </div> <div style="margin-left: 20px;"> </div> </div>

■ S2C649 to S2C651: COOLING FAN ALARM 1 OPERATION

■ S2C652 to S2C654: COOLING FAN ALARM 2 OPERATION

■ S2C655 to S2C657: COOLING FAN ALARM 3 OPERATION

These parameters specify the operation of cooling fan 1 to 3 with alarm sensor, connected to power ON unit.

Each bit specifies the power ON unit to which the detecting sensor is connected.

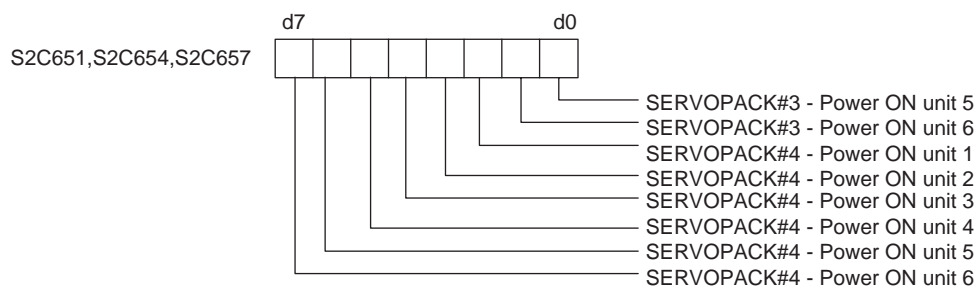
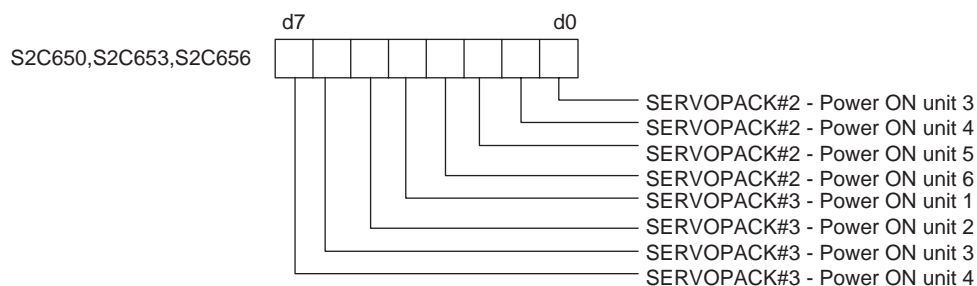
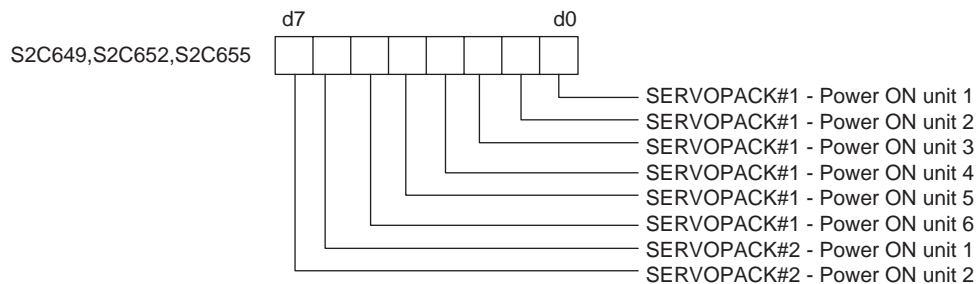

- S2C658 to S2C660: FAN ALARM 1 POWER SOURCE STATUS
- S2C661 to S2C663: FAN ALARM 2 POWER SOURCE STATUS
- S2C664 to S2C666: FAN ALARM 3 POWER SOURCE STATUS

8.9 TRANSMISSION PARAMETERS

■ RS000: COMMUNICATION PROTOCOL

The protocol of the serial port of the NCP01 circuit board is specified.

- 0: No protocol
- 2: Basic protocol
- 3: FC1 protocol

8.9.1 Basic Protocol

Specify when using Yaskawa data transmission functions.

■ RS030: NUMBER OF DATA BITS

This parameter specifies the number of data bits.

■ RS031: NUMBER OF STOP BITS

This parameter specifies the number of stop bits.

■ RS032: PARITY

This parameter specifies the parity bits.

■ RS033: TRANSMISSION SPEED

This parameter specifies the transmission speed in units of bauds.

■ RS034: RESPONSE WAITING TIMER (TIMER A)

Units: 0.1 seconds

This timer monitors the sequence. It specifies the response waiting time for invalid or missing responses.

■ RS035: TEXT TERMINATION MONITORING TIMER (TIMER B)

This timer monitors text reception. Specify the monitoring time to wait for text termination character.

■ RS036: NUMBER OF ENQ RE-TRANSMISSION RETRIES

This parameter specifies the number of re-transmission attempts of the control characters for invalid or missing responses.

■ RS037: NUMBER OF DATA RE-TRANSMISSION RETRIES

This parameter specifies the number of re-transmission attempts of text for block check error (NAK reception).

■ RS038: BLOCK CHECK METHOD

This parameter specifies the checking method for text transmission errors. Set "0" for this protocol.

8.9.2 FC1 Protocol

The following protocols naturally correspond to the external memory unit, YASNAC FC1 or FC2.

■ RS050: NUMBER OF DATA BITS

This parameter specifies the number of data bits.

■ RS051: NUMBER OF STOP BITS

This parameter specifies the number of stop bits.

■ RS052: PARITY

This parameter specifies the parity bits.

■ RS053: TRANSMISSION SPEED

This parameter specifies the transmission speed in units of bauds.

■ RS054: RESPONSE WAITING TIMER (TIMER A)

Units: 0.1 seconds

This timer monitors the sequence. It specifies the response waiting time for invalid or missing responses.

■ RS055: TEXT TERMINATION MONITORING TIMER (TIMER B)

This timer monitors text reception. Specify the monitoring time to wait for text termination character.

■ RS056: NUMBER OF ENQ RE-TRANSMISSION RETRIES

This parameter specifies the number of re-transmission attempts of the control characters for invalid or missing responses.

■ **RS057: NUMBER OF DATA RE-TRANSMISSION RETRIES**

This parameter specifies the number of re-transmission attempts of text for block check error (NAK reception).

■ **RS058: FC2 FORMAT SPECIFICATION**

Specify the format type of the floppy disk used with external memory (YASNAC FC2).

NOTE 720 kilobytes are unconditionally specified for YASNAC FC2 (2DD floppy disk exclusive use).

■ **RS059: EXTERNAL MEMORY FILE OVERWRITE SPECIFICATION**

Specify whether to accept the file overwrite of the external memory (YASNAC FC2 or FC1).

8.10 Application Parameters

8.10.1 Arc Welding

■ **AxP000: APPLICATION**

This parameter specifies the application. Set “0” for arc welding.

■ **AxP003: WELDING ASSIGNMENT OF WELDING START CONDITION FILE**

This parameter specifies the beginning condition number in the welding start condition file to be assigned to Power Source 2. Condition files of a lower number are automatically assigned to Power Source 1. For a system with one Power Source, set “49” (maximum value).

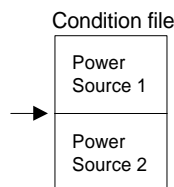

■ **AxP004: WELDING ASSIGNMENT OF WELDING END CONDITION FILES**

This parameter specifies the beginning condition number in the welding END condition file to be assigned to Power Source 2. Condition files of a lower number are automatically assigned to Power Source 1. For a system with one Power Source, set “13” (maximum value).

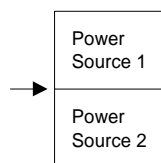

■ AxP005: WELDING SPEED PRIORITY

This parameter specifies whether the welding speed is specified by the “ARCON” instruction, by the welding start condition file, or by the additional times of the “MOV” instruction.

■ AxP009: WORK CONTINUING

This parameter specifies whether to output an “ARCON” instruction to restart after the manipulator stopped while the “ARCON” instruction is being output.

■ AxP010: WELDING INSTRUCTION OUTPUT

This parameter specifies the beginning number (0 to 12) of the analog output channel to the Power Source. “0” indicates that no Power Source exists.

■ AxP011, AxP012: MANUAL WIRE OPERATION SPEED

These parameters specify the manual wire operation speed as a percentage of the maximum instruction value. Instruction polarity is determined by the current instruction in the Power Source characteristic file. The setting range is from 0 to 100.

■ AxP013, AxP014: WELDING CONTROL TIME

These parameters specify the welding control time in units of minutes. The setting range is from 0 to 999.

■ AxP015 to AxP017: NUMBER OF WELDING CONTROL

These parameters specify the number of welding controls. The setting range is from 0 to 99.

■ AxP026 to AxP029: TOOL ON/OFF USER OUTPUT NO. (Jigless system)

These parameters specify the user output number for the tool open/close operation by specific keys.

8.10.2 Handling Application

■ AxP002, AxP004: f1 KEY FUNCTION

These parameters set the output signal to assign for f1 key.

0: Not specified

1 to 4: Specific outputs for HAND-1 to HAND4-1

5: User output (No. is specified by AxP004).

■ **AxP003, AxP005: f2 KEY FUNCTION**

These parameters set the output signal to assign for f2 key.

- 0: Not specified
- 1 to 4: Specific outputs for HAND-2 to HAND4-2
- 5: User output (No. is specified by AxP005)

8.10.3 Spot Welding

■ **AxP003: MAXIMUM NUMBERS OF CONNECTED POWER SOURCES**

The initial value is set to 4. The value is automatically set at start-up. No modification is needed.

■ **AxP004: GUN FULL OPEN STROKE ON/OFF SIGNAL**

This parameter specifies which stroke switching signal is output ON or OFF to make the gun fully-opened for each gun.

Bit specification (1 for 01) for 8 guns. The initial setting is "0."

```
0 0 0 0 0 0 0 0
| | | | | | | |
8 7 6 5 4 3 2 1   Gun number
```

■ **AxP005: STROKE CHANGE ANSWER TIME LIMIT**

When using the X2 gear mechanical stopper gun and switching gun stroke, this parameter sets the time from the stroke-switching-sequence start until the pressure instruction end.

Setting range: 0.0 to 9.9 sec.

The initial setting is "0," with which the switching signal is output for the "stopper-type stroke switching time" set in the file, and then the gun pressure instruction is turned OFF.

■ **AxP006: PARITY SPECIFICATION FOR WELDING CONDITIONS**

When adding the parity signal to the welding condition signal with the Power Source connected to each welding gun, this parameter specifies odd or even parity.

Bit specification for 4 Power Sources. (0 : odd number, 1 : even number) The initial setting is "0."

```
0 0 0 0 0 0 0 0
      | | | |
      4 3 2 1   Power Source number
```

■ **AxP007: ANTICIPATE TIME**

When executing the GUNCL or SPOT instruction with NWAIT specified in the previous move instruction but the time is not specified by ATT in the GUNCL or SPOT instruction, this parameter specifies the anticipate condition (time). The initial setting is "0," with which the each instruction is executed as soon as the taught position of the previous move instruction is reached, as normal operation.

■ AxP015: WELDING ERROR RESET OUTPUT TIME

This parameter sets the output time of the welding error reset signal to the Power Source when the alarm reset signal is input.

If the setting is "0," the welding error reset signal is not output to the Power Source even if the alarm reset signal is input.

■ AxP016, AxP017: ELECTRODE WEAR AMOUNT ALARM VALUE

These parameters set the electrode wear amount alarm values (AxP016: movable side, AxP017: fixed side) at the wear detection.

8.10.4 General-purpose Application**■ AxP009: WORK CONTINUE PROHIBIT**

This parameter specifies whether to output TOOLON instruction or not at restarting when the work is stopped for some reasons during the output of TOOLON instruction.

9 Painting Application

9.1 Function Keys

The function keys for painting application are assigned to the Numeric keys as described below.



Registers a timer instruction, "TIMER," in a job.



Registers a reference point, "REFP," in a job or changes an already-registered reference point.
Press [REFP] + [FWD] to move the manipulator to the registered reference point.



<Teach Mode>
Used to output a permission signal to prohibit painting of a spray signal. To turn OFF the permission signal, press this key again.

<Play Mode>
Used to stop outputting a spray signal while the spray signal is being output by the SPYON instruction. To start outputting the spray signal, press this key again.



Displays the PAINT CONDITION window.



Registers an instruction to start the spray, "SPYON," in a job.



Registers an instruction to end the spray, "SPYOF," in a job.



The output destinations of the spray signal and the atomization pressure signal are written in the concurrent I/O ladder program.

If the connection of the destinations of the user output signals is changed in the painting system's configuration, also change the destinations in the concurrent I/O ladder program. Unless the destinations are set correctly, a spray signal or an atomization pressure signal cannot be output correctly.



In a system configuration where more than two sprays are connected, the operation of all sprays is controlled by the "PAINT ON/OFF" key.

9.2 Outline of Operations and Painting Functions

9.2.1 Example of Painting System Configuration

The following diagram shows an example of system configuration where the paint control panel controls the painting devices.

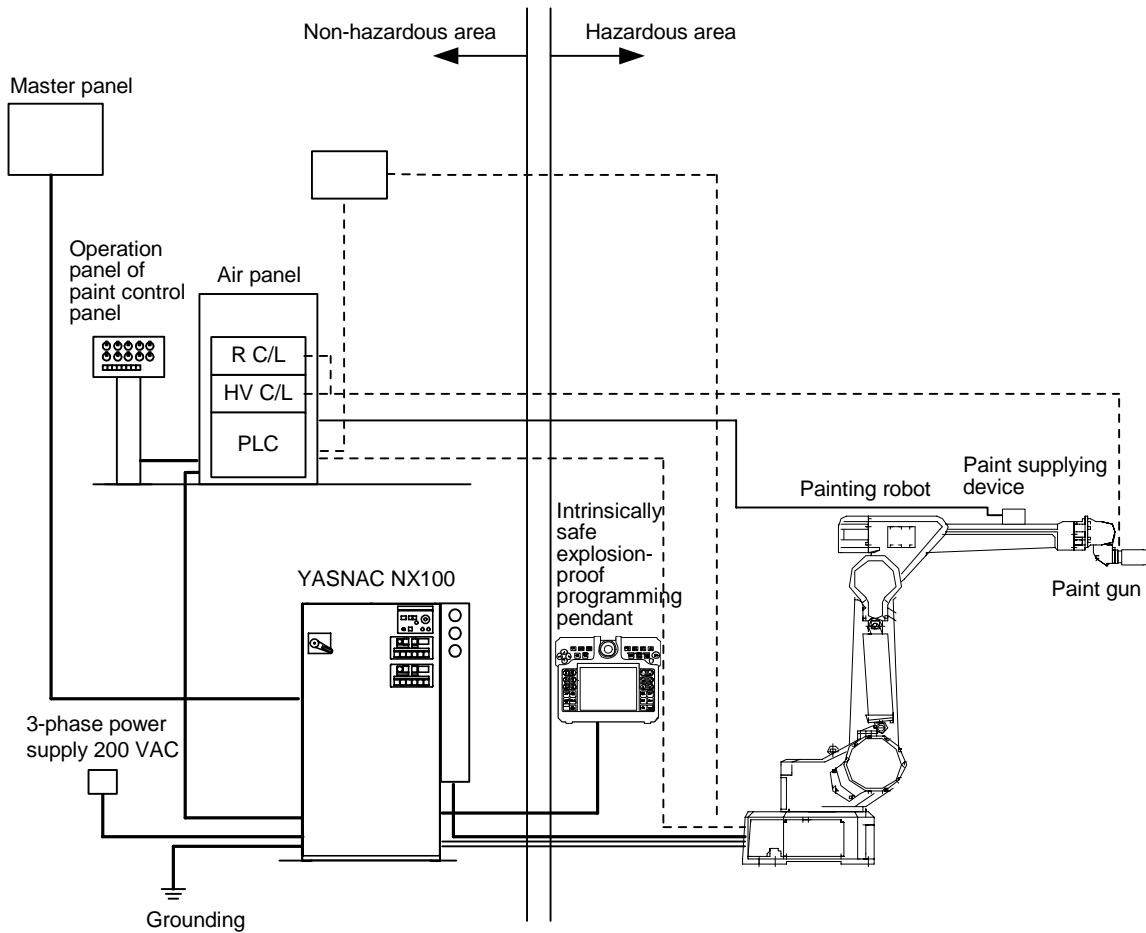

9.2.2 Settings for Painting System When Using a Spray Gun

	Item	Description	Settings	Remarks
1	Gun Type	Sets the type of gun to be used.	"SPRAY"	
2	Supply Type	Sets the paint supplying device.	"UNUSED"	
3	Number of Connected CCVs	Sets the number of CCVs to be connected.	0	Not necessary to set.
4	Atomized Air Output	Sets the output method of the atomized air.	"I/O OUTPUT" or "LEVEL"	
5	Pattern Output	Sets the output method for atomizing pattern.	"I/O OUTPUT" or "LEVEL"	

9.2.3 Settings for Painting System When Using a Bell Gun

	Item	Description	Settings	Remarks
1	Gun Type	Sets the type of gun to be used.	"BELL"	
2	Supply type	Sets the paint supplying device.	"UNUSED"	
3	Number of Connected CCVs	Sets the number of CCVs to be connected.	0	Not necessary to set.
4	Turbine Output	Sets the method to control the number of bell rotations by turbine.	"I/O OUTPUT" or "LEVEL"	
5	Shaping Output	Sets the method to control the shaping air pressure.	"I/O OUTPUT" or "LEVEL"	

9.3 Teaching for Painting Operations

Taking an example where a workpiece, such as the one shown in the following diagram, is to be painted, the following flowchart outlines the operational procedure and the robot program for the reference job that are necessary to use the manipulator for painting operations.

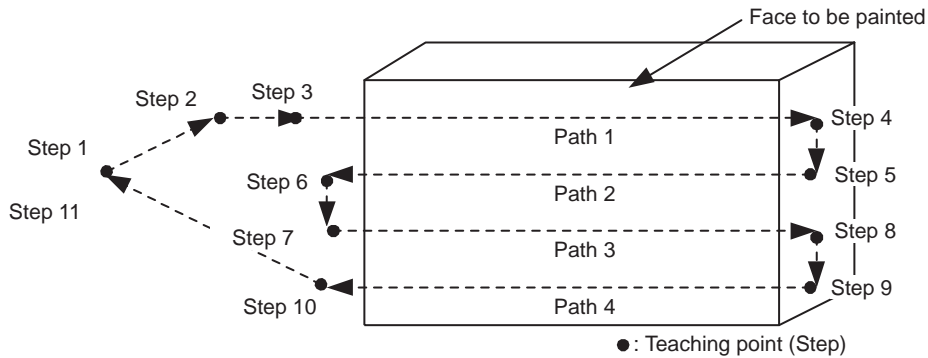

Operational Procedure

Create a job.	Teach manipulator's motions (reference job) to perform painting.
↓	
Set instructions to start and stop the spray. (Register the work instructions.)	Set a start instruction and an end instruction for the spray to be used for the workpiece to be painted.
↓	
Confirm the motion. (Test run)	Confirm the manipulator's motion in a test run without painting.
↓	
Fine-tune a job. Reset the painting conditions.	Carry out the painting test to fine-tune the teaching data, and reset or modify the painting conditions.
↓	
Start the actual production. (Automatic operation)	Teaching has been successfully completed. Start the actual production with the manipulator.

Reference Job

Line	Instruction	Description
0000	NOP	
0001	MOVJ VJ=25.00	Move to the standby position (Step 1)
0002	MOVL V=50	Move to a position near the start position for painting (Step 2)
0003	MOVL V=50 NWAIT	Move to the start position for painting (the start point of path 1) (Step 3)
0004	SPYON	Spray ON
0005	MOVL V=100	Move to the end point of path 1 (Step 4)
0006	MOVL V=100	Move to the start point of path 2 (Step 5)
0007	MOVL V=100	Move to the end point of path 2 (Step 6)
0008	MOVL V=100	Move to the start point of path 3 (Step 7)
0009	MOVL V=100	Move to the end point of path 3 (Step 8)
0010	MOVL V=100	Move to the start point of path 4 (Step 9)
0011	MOVL V=100 NWAIT	Move to the end point of path 4 (Step 10)
0012	SPYOF	Spray OFF
0013	MOVL V=50	Move to the standby position (Step 11)
0014	END	

9.4 Anticipation Output Function

The anticipation output function is a function to quicken or slow the execution timing of painting start/end instructions. Using this function, a paint start or end instruction can be carried out before or after the step is reached.

“ANT=” is used when anticipation output is performed.

“ANT=” can be added to the following two instructions:

SPYON (spray start)

SPYOF (spray stop)

To carry out anticipation output, set the time “ANT=**second,” add it to the SPYON or SPYOF instruction, and set “NWAIT” to the move instruction of the step.

Setting the time to a negative value (-) advances the signal output.

Setting the time to a positive value (+) delays the signal output.

9.4.1 Example

Advanced Signal Output

While the manipulator moves towards step n, painting starts 0.5 seconds before step n is reached; and stops 0.5 seconds before step n+1 is reached while the manipulator moves towards step n+1.

Step	Instructions
:	:
n-2	MOVL
n-1	MOVL NWAIT SPYON ANT=-0.5
n	MOVL NWAIT SPYOF ANT=-0.5
n+1	MOVL
:	:

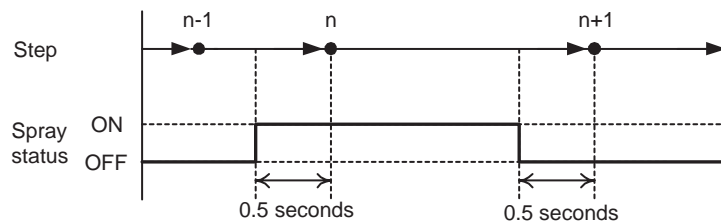

Delayed Signal Output

While the manipulator moves towards step n+1, painting starts 0.5 seconds after step n is reached; and stops 0.5 seconds after step n+1 is reached while the manipulator moves towards the next step.

Step	Instructions
:	:
n-2	MOVL
n-1	MOVL NWAIT SPYON ANT=0.5
n	MOVL NWAIT SPYOF ANT=0.5
n+1	MOVL
:	:

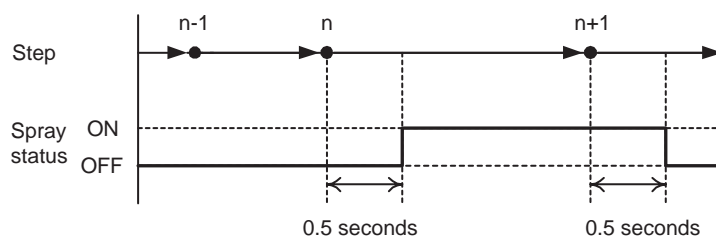

9.4.2 Notes on Anticipation Output Function

- If the time required by the manipulator to reach step n from step n-1 by a SPYON instruction is shorter than the time set at “ANT=XX,” painting starts when the cursor moves to the SPYON instruction.

Step	Instructions
:	:
n-2	MOVL
n-1	MOVL NWAIT SPYON ANT=2.0
n	MOVL
n+1	MOVL
:	:

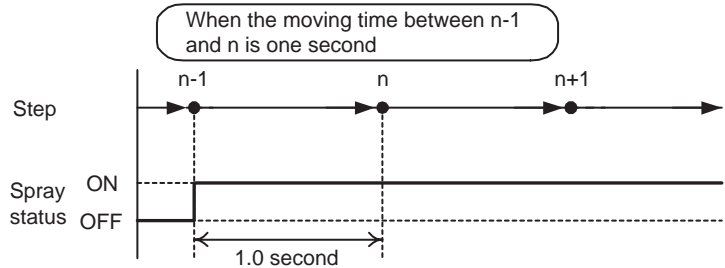

If the time required by the manipulator to reach n+1 from n is shorter than the time set at “ANT=XX,” painting starts when the manipulator reaches step n+1.

Step	Instructions
:	:
n-2	MOVL
n-1	MOVL NWAIT SPYON ANT=2.0
n	MOVL
n+1	MOVL
:	:

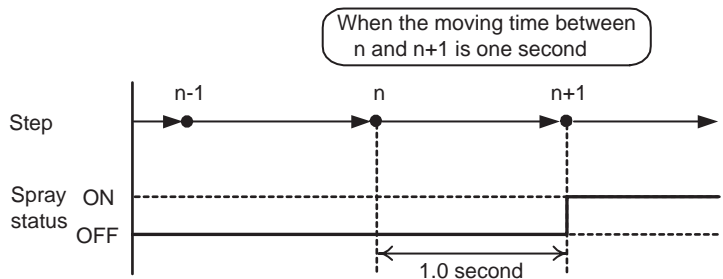

- If NWAIT is not added to step n, painting starts immediately after the manipulator reaches step n.

Step	Instructions
:	:
n-2	MOVL
n-1	MOVL SPYON ANT=-0.5
n	MOVL SPYOF ANT=-0.5
n+1	MOVL
:	:

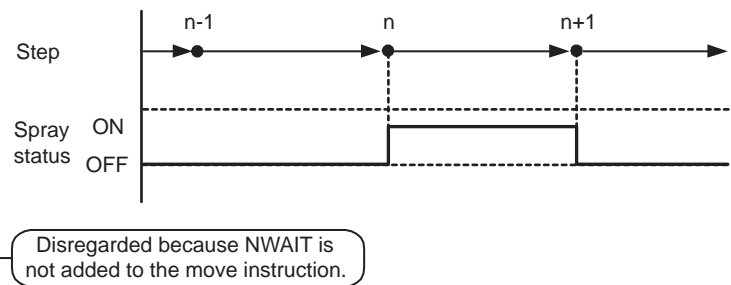

- If a CALL or JUMP instruction is added before the SPYON instruction, the NWAIT operation is interrupted and the setting of “ANT=XX” is disregarded. Painting starts when the cursor moves to the SPYON instruction.
- The NWAIT operation is not performed in a FWD/BWD operation or during playback in one step. Therefore, the same operations as those done when NWAIT is not set are performed.
- Because the NWAIT operation is not continued when the manipulator is restarted after an emergency stop, the path differs from the continuous operation path.



If NWAIT is not added to the move instruction before the SPYON/SPYOFF instruction, the execution timing of SPYON/SPYOFF becomes the same as the normal DOUT instruction, and spray ON/OFF cannot be executed at the desired timing. Be sure to add NWAIT to the move instruction before the SPYON/SPYOFF instruction.

9.5 Registering Work Instructions

9.5.1 SPYON

The SPYON instruction is used to start painting.

As a work start instruction, the instruction turns ON the Specific Output Signals corresponding to the specified gun number.

The instruction also sets the advance time for turning ON the splay and the delay time for turning ON the atomizing in the register. These times are set in the painting system characteristics setting file.



Function key to register an instruction to start the spray "SPYON"



Select {DEVICE} in the instruction group list when registering the SPYON instruction from [INFORM LIST].

■ Registering the SPYON Instruction

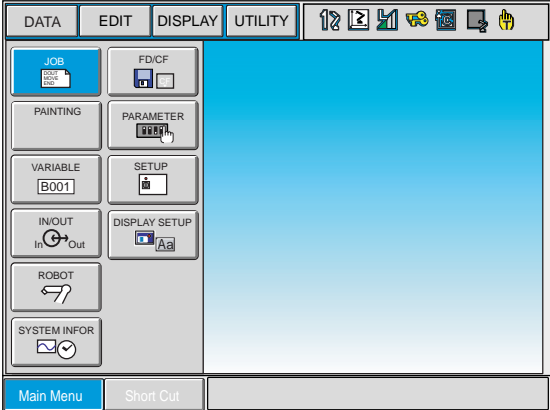
	Operation	Explanation
1	Select {JOB} under the main menu.	 <p>The screenshot shows a software interface with a menu on the left and a toolbar at the top. The menu items are: JOB (highlighted in blue), PAINTING, VARIABLE (B001), IN/OUT (In/Out), ROBOT, SYSTEM INFOR, FD/CF, PARAMETER (with a cursor over it), SETUP, and DISPLAY SETUP. At the bottom of the menu are 'Main Menu' and 'Short Cut' buttons. The toolbar contains various icons for file operations and system functions.</p>

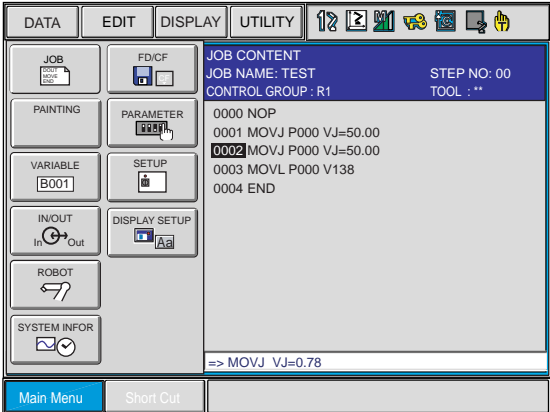
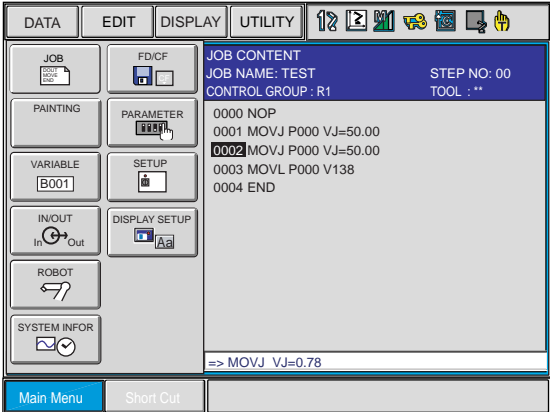
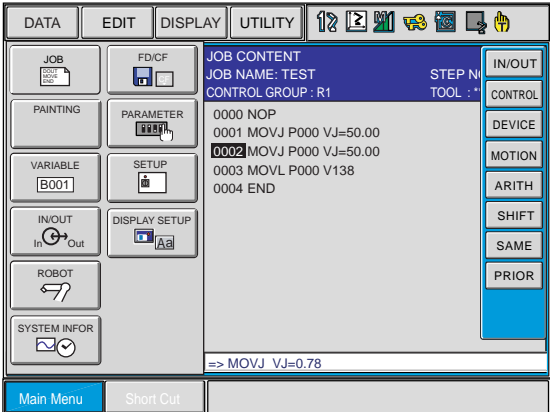
	Operation	Explanation
2	Select {JOB}.	<p>The JOB CONTENT window appears.</p> 
3	Move the cursor to the address area.	
4	Press [INFORM LIST].	<p>The instruction list dialog box appears.</p> 

9.5 Registering Work Instructions

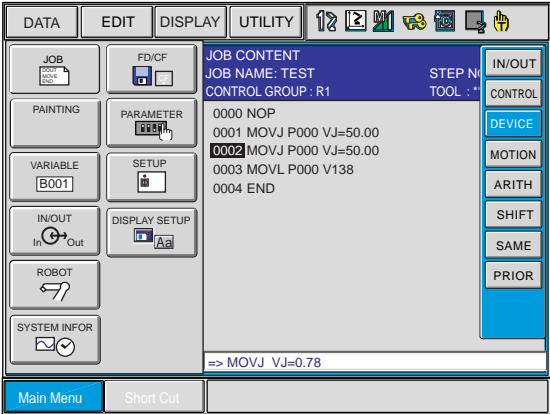
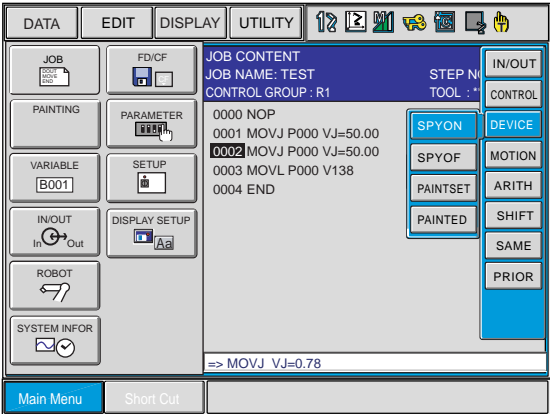
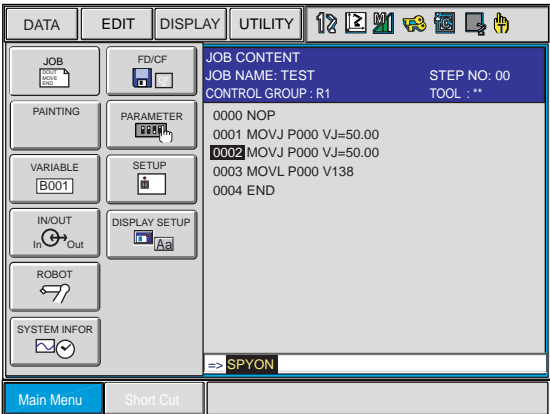
	Operation	Explanation
5	Select {DEVICE}.	 <p>The screenshot shows the 'JOB CONTENT' screen with the following details:</p> <ul style="list-style-type: none"> Menu: DATA, EDIT, DISPLAY, UTILITY Buttons: JOB, FD/CF, PAINTING, PARAMETER, VARIABLE [B001], SETUP, IN/OUT, DISPLAY SETUP, ROBOT, SYSTEM INFOR Job Content: <ul style="list-style-type: none"> JOB NAME: TEST CONTROL GROUP: R1 STEP NO: 0000 TOOL: ** 0000 NOP 0001 MOVJ P000 VJ=50.00 0002 MOVJ P000 VJ=50.00 0003 MOVL P000 V138 0004 END Right-hand menu: IN/OUT, CONTROL, DEVICE, MOTION, ARITH, SHIFT, SAME, PRIOR Input buffer: => MOVJ VJ=0.78 Bottom: Main Menu, Short Cut
6	Select {SPYON}.	 <p>The screenshot shows the 'JOB CONTENT' screen with the following details:</p> <ul style="list-style-type: none"> Menu: DATA, EDIT, DISPLAY, UTILITY Buttons: JOB, FD/CF, PAINTING, PARAMETER, VARIABLE [B001], SETUP, IN/OUT, DISPLAY SETUP, ROBOT, SYSTEM INFOR Job Content: <ul style="list-style-type: none"> JOB NAME: TEST CONTROL GROUP: R1 STEP NO: 0000 TOOL: ** 0000 NOP 0001 MOVJ P000 VJ=50.00 0002 MOVJ P000 VJ=50.00 0003 MOVL P000 V138 0004 END Right-hand menu: IN/OUT, CONTROL, SPYON, MOTION, ARITH, SHIFT, SAME, PRIOR Input buffer: => MOVJ VJ=0.78 Bottom: Main Menu, Short Cut <p>"SPYON" instruction appears in the input buffer line.</p>  <p>The screenshot shows the 'JOB CONTENT' screen with the following details:</p> <ul style="list-style-type: none"> Menu: DATA, EDIT, DISPLAY, UTILITY Buttons: JOB, FD/CF, PAINTING, PARAMETER, VARIABLE [B001], SETUP, IN/OUT, DISPLAY SETUP, ROBOT, SYSTEM INFOR Job Content: <ul style="list-style-type: none"> JOB NAME: TEST CONTROL GROUP: R1 STEP NO: 00 TOOL: ** 0000 NOP 0001 MOVJ P000 VJ=50.00 0002 MOVJ P000 VJ=50.00 0003 MOVL P000 V138 0004 END Right-hand menu: IN/OUT, CONTROL, MOTION, ARITH, SHIFT, SAME, PRIOR Input buffer: => SPYON Bottom: Main Menu, Short Cut

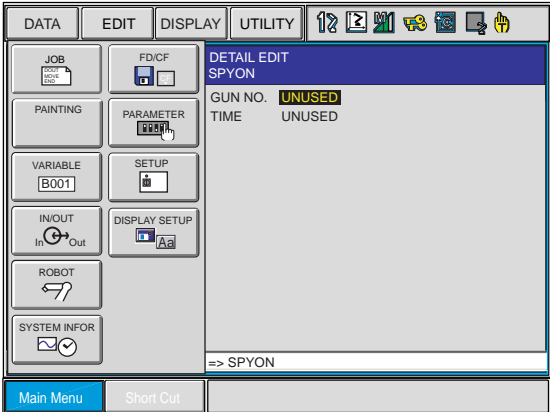
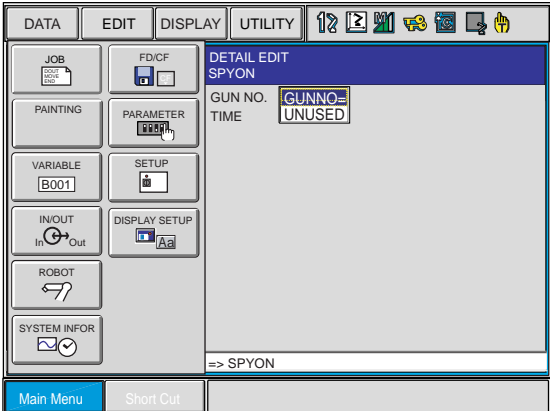
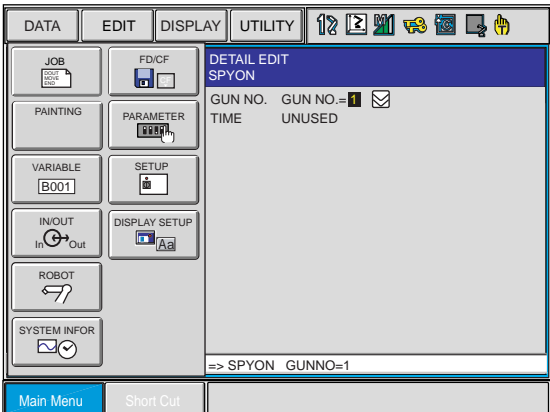
Operation	Explanation
<p>7 Press [SELECT] and set each item in the DETAIL EDIT window.</p>	<p>The DETAIL EDIT window appears.</p>  <p>Move the cursor to the item to be set and press [SELECT].</p>  <p>Use the Numeric keys to input the setting and press [ENTER].</p>  <p>The setting appears in the input buffer line.</p>

9.5 Registering Work Instructions

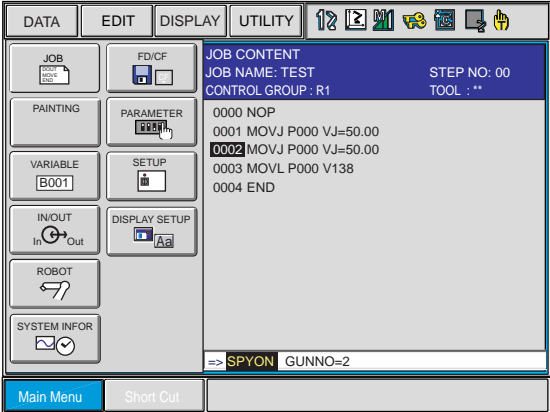
	Operation	Explanation
8	Press [ENTER].	<p>When [ENTER] is pressed, the setting is registered in the job.</p>  <p>To cancel the setting, press [CANCEL]. The window returns to the JOB CONTENT window.</p>

■ Registering the SPYON Instruction in a One-touch Operation

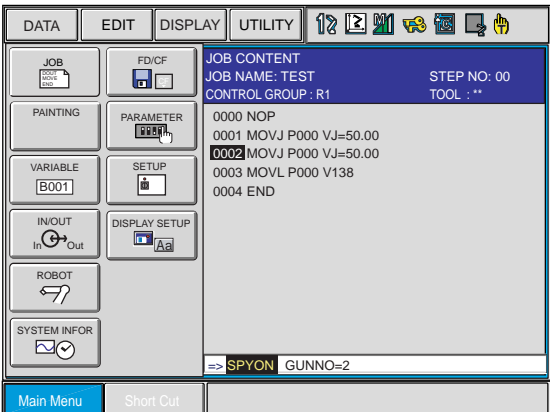
	Operation	Explanation
1	Press [8 / SPRAY ON].	<p>"SPYON" appears in the input buffer line.</p> 
2	Press [ENTER] to register SPYON.	

Syntax for the SPYON instruction

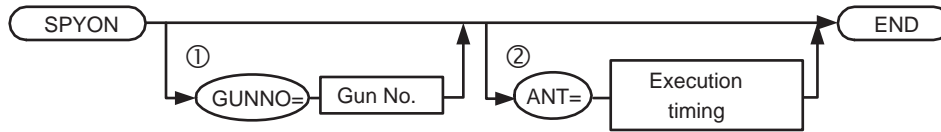

① Gun No. (Setting range: 1 to 4)

Controls the work start signal of the Specific Output Signals corresponding to the specified gun number.

If setting is omitted, 1 is applied for the gun number.

② Execution timing (Setting range: -327.68 to 327.67)

Sets the anticipation time (advance time, delay time) in units of seconds.

If setting is omitted, 0 is applied for the anticipation time.

9.5.2 Notes on the SPYON Instruction

When a SPYON instruction is carried out, the Specific Output Signals (a work start instruction) corresponding to the specified gun number turns ON. The instruction also sets the advance time for turning ON the spray and the delay time for turning ON the atomizing in the register. These times are set in the painting system characteristics setting file.

The concurrent I/O ladder program controls the actual outputs of the spray signal and atomization signal according to the ON status of the work start instruction of the Specific Output Signals and the advance time for turning ON the spray and the delay time for turning ON the atomizing that are set in the register. The graph shows the timing of when the spray signal and the atomization pressure signal are turned ON.

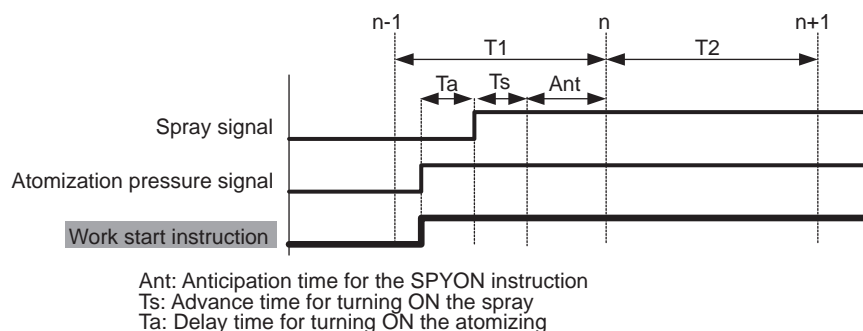

When the system configuration or the output destination of the spray or atomization pressure signals is changed, be sure to make changes in the concurrent I/O ladder program.

9.5.3 SPYOF

The SPYOF instruction is used to complete painting.

The instruction turns OFF the Specific Output Signals (a work start instruction) corresponding to the specified gun number.

The instruction also sets the advance time for turning OFF the spray and the delay time for turning OFF the atomizing in the register. These times are set in the painting system characteristics setting file.



Function key to register an instruction to end the spray "SPYOF"



Select {DEVICE} in the instruction group list when registering the SPYOF instruction from [INFORM LIST].

■ Registering the SPYOF Instruction

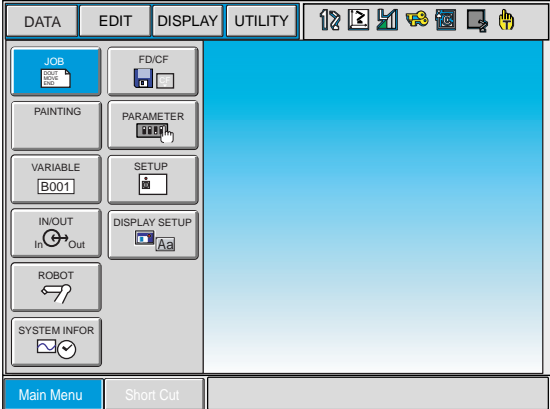
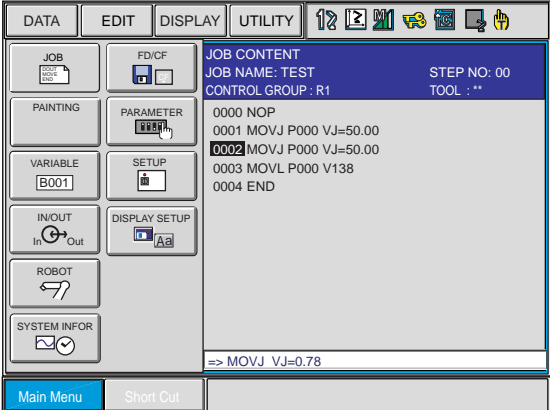
	Operation	Explanation
1	Select {JOB} under the main menu.	
2	Select {JOB}.	<p>The JOB CONTENT window appears.</p> 

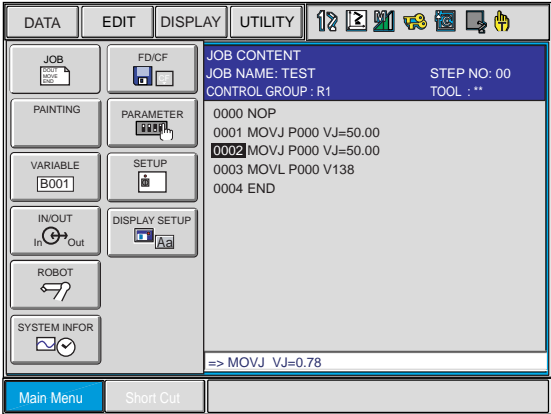
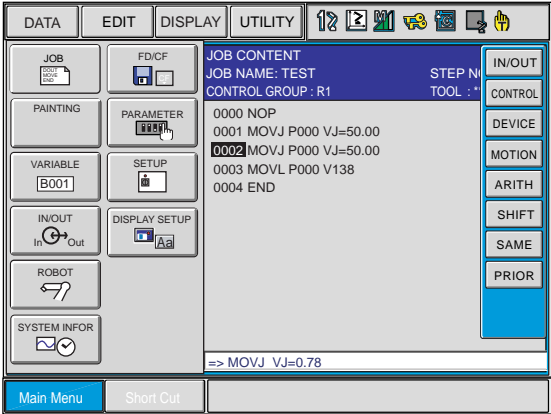
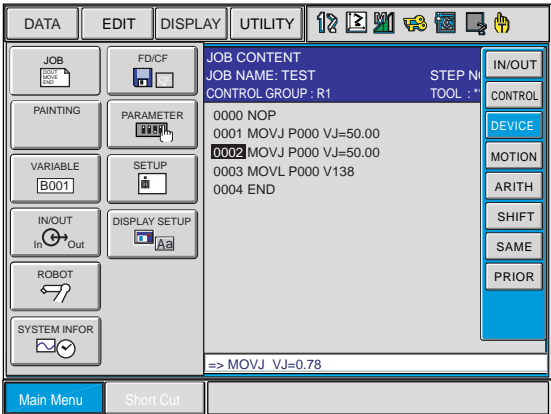
	Operation	Explanation
3	Move the cursor to the address area.	 <p>The screenshot shows the 'JOB CONTENT' dialog box with the instruction list. The instruction '0002 MOVJ P000 VJ=50.00' is selected, and the cursor is positioned on the address field 'VJ=50.00'. The interface includes a menu bar (DATA, EDIT, DISPLAY, UTILITY) and various function buttons on the left side.</p>
4	Press [INFORM LIST].	 <p>The screenshot shows the 'JOB CONTENT' dialog box with the instruction list. The 'IN/OUT' menu is open, displaying options: IN/OUT, CONTROL, DEVICE, MOTION, ARITH, SHIFT, SAME, and PRIOR. The cursor is positioned on the 'DEVICE' option.</p>
5	Select {DEVICE}.	 <p>The screenshot shows the 'JOB CONTENT' dialog box with the instruction list. The 'IN/OUT' menu is open, and the 'DEVICE' option is highlighted in blue, indicating it has been selected.</p>

9.5 Registering Work Instructions

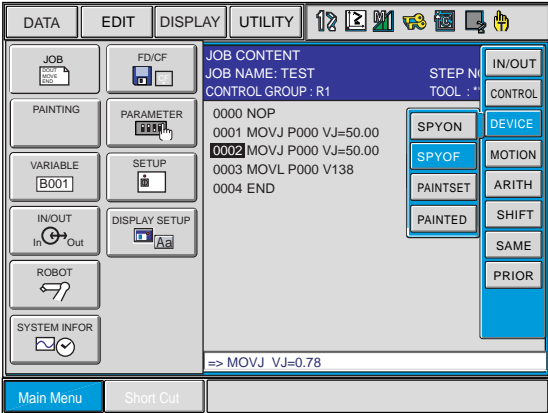
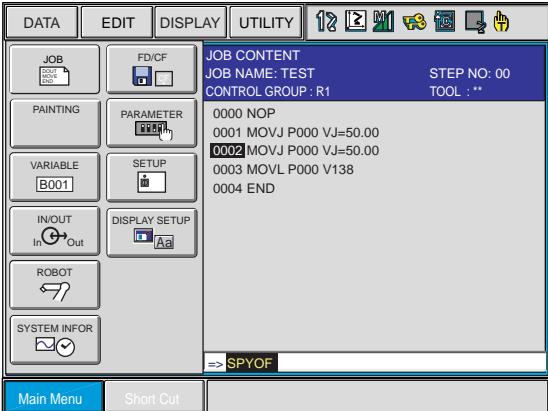
Operation	Explanation
6 Select {SPYOF}.	 <p>"SPYOF" instruction appears in the input buffer line.</p> 

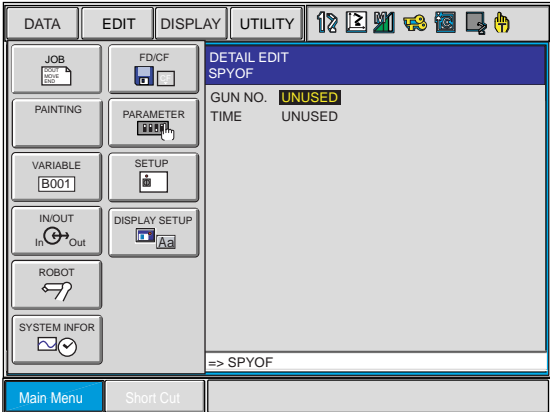
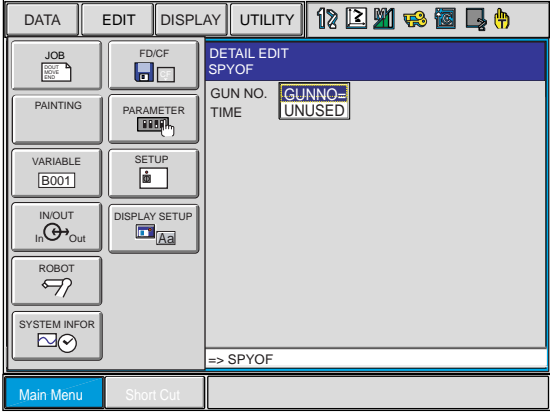
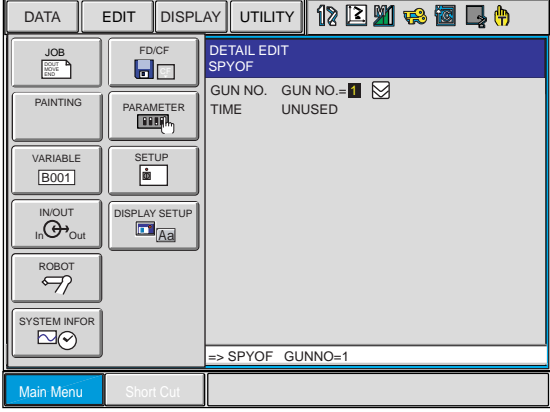
Operation	Explanation
<p>7 Press [SELECT] and set each item in the DETAIL EDIT window.</p>	<p>The DETAIL EDIT window appears.</p>  <p>Move the cursor to the item to be set and press [SELECT].</p>  <p>Use the Numeric keys to input the setting and press [ENTER].</p>  <p>The setting appears in the input buffer line.</p>

9.5 Registering Work Instructions

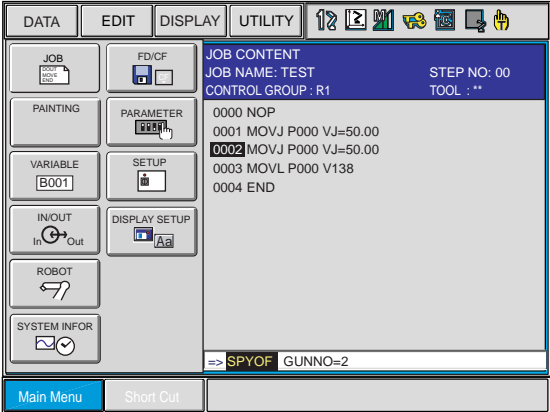
	Operation	Explanation
8	Press [ENTER].	<p>When [ENTER] is pressed, the setting is registered in the job.</p>  <p>To cancel the setting, press [CANCEL]. The window returns to the JOB CONTENT window.</p>

■ Registering the SPYOF Instruction in a One-touch Operation

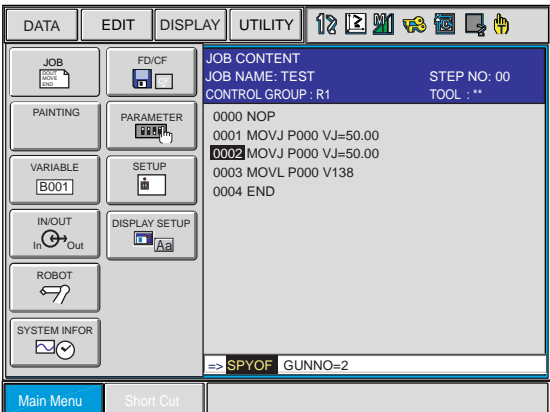
	Operation	Explanation
1	Press [9 / SPRAY OFF].	<p>"SPYOF" appears in the input buffer line.</p> 
2	Press [ENTER] to register SPYOF.	

Syntax for the SPYOF instruction

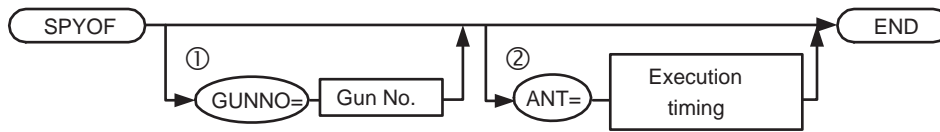

① Gun No. (Setting range: 1 to 4)

Controls the work start signal of the Specific Output Signals corresponding to the gun number.

If setting is omitted, 1 is applied for the gun number.

② Execution timing (Setting range: -327.68 to 327.67)

Sets the anticipation time (advance time, delay time) in units of seconds.

If setting is omitted, 0 is applied for the anticipation time.

9.5.4 Notes on the SPYOF Instruction

When a SPYOF instruction is carried out, the Specific Output Signals (a work start instruction) corresponding to the specified gun number turns OFF. The instruction also sets the advance time for turning OFF the spray and the delay time for turning OFF the atomizing in the register. These times are set in the painting system characteristics setting file.

The concurrent I/O ladder program controls the actual outputs of the spray signal and atomization signal according to the OFF status of the work start instruction of the Specific Output Signals and the advance time for turning OFF the spray and the delay time for turning OFF the atomizing that are set in the register. The graph shows the timing of when the spray signal and the atomization pressure signal are turned OFF.

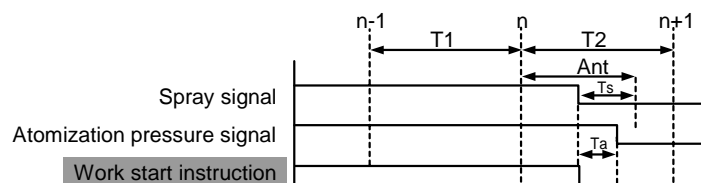

Ant: Anticipation time for the SPYOF instruction
 Ts: Advance time for turning OFF the spray
 Ta: Delay time for turning OFF the atomizing



When the system configuration or the output destination of the spray or atomization pressure signals is changed, be sure to make changes in the concurrent I/O ladder program.

9.5.5 PAINTSET

The PAINTSET instruction is used to set the painting conditions for the painting machine controller.

■ Registering the PAINTSET Instruction

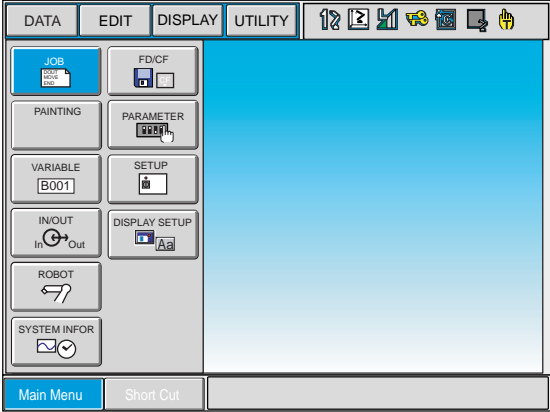
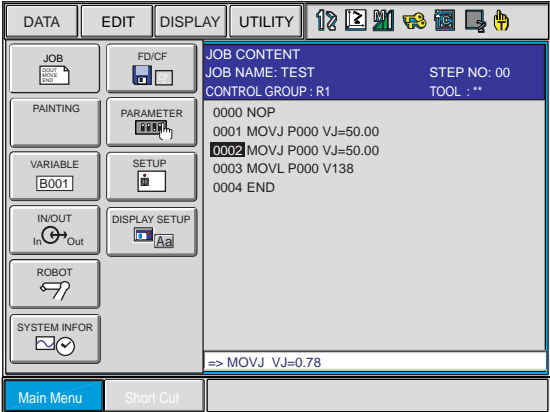
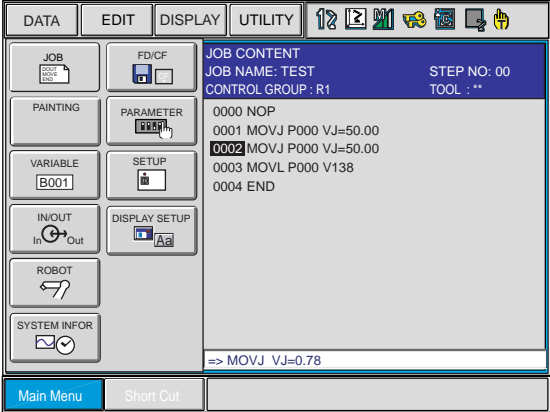
	Operation	Explanation
1	Select {JOB} under the main menu.	
2	Select {JOB}.	<p>The JOB CONTENT window appears.</p> 
3	Move the cursor to the address area.	

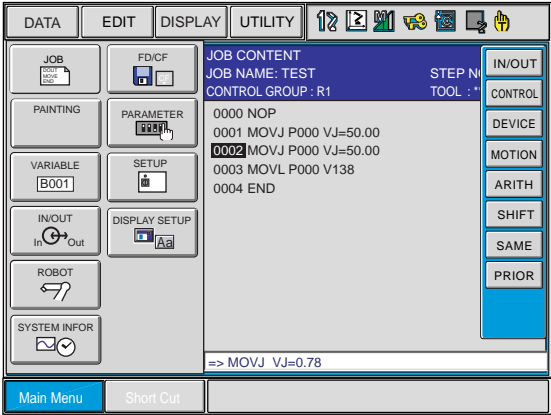
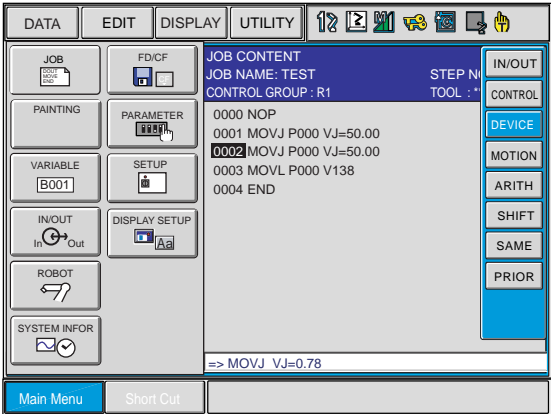
	Operation	Explanation
4	Press [INFORM LIST].	<p>The instruction list dialog box appears.</p> 
5	Select {DEVICE}.	

9.5 Registering Work Instructions

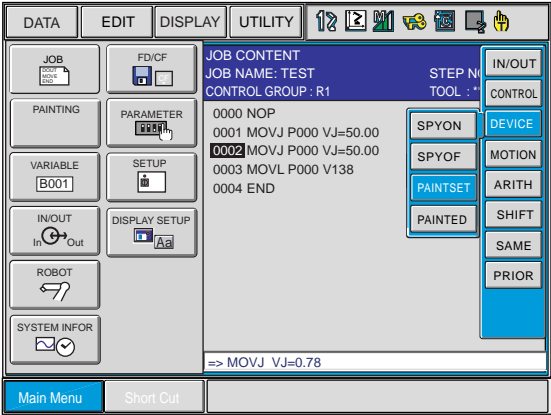
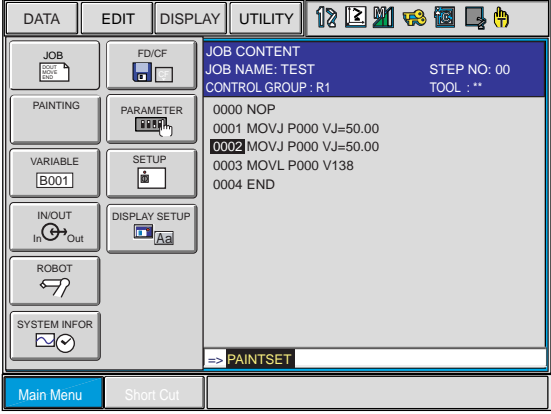
Operation	Explanation
6 Select {PAINTSET}.	 <p>The screenshot shows the robot control interface with the 'JOB CONTENT' window. The 'JOB NAME' is 'TEST' and the 'CONTROL GROUP' is 'R1'. The program code is displayed as follows:</p> <pre> 0000 NOP 0001 MOVJ P000 VJ=50.00 0002 MOVJ P000 VJ=50.00 0003 MOVL P000 V138 0004 END </pre> <p>The 'PAINTSET' instruction is highlighted in the input buffer line at the bottom of the window, with the text '=> PAINTSET'.</p> <p>"PAINTSET" instruction appears in the input buffer line.</p>  <p>The second screenshot shows the same robot control interface, but the 'PAINTSET' instruction is now entered into the input buffer line, with the text '=> PAINTSET'.</p>

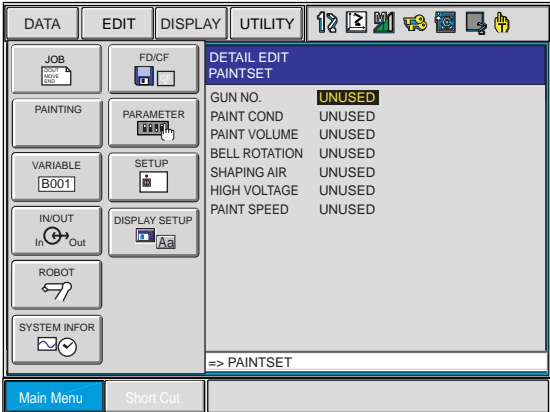
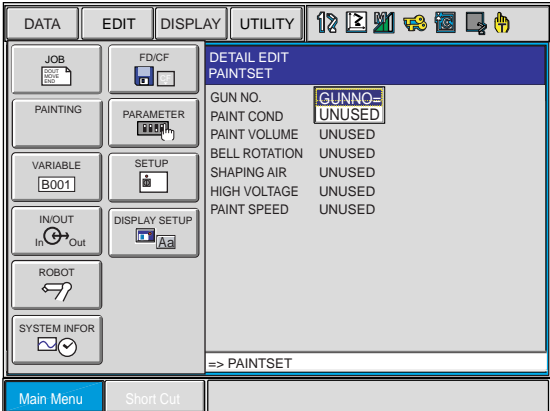
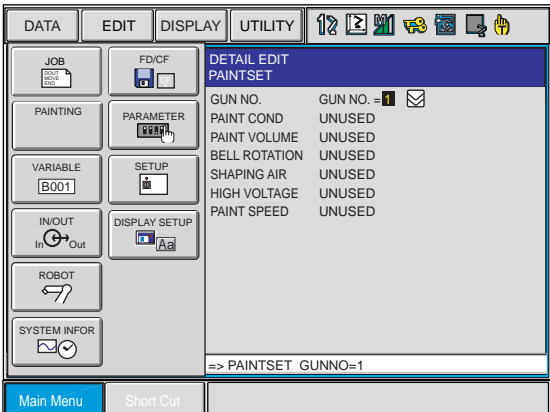
Operation	Explanation
<p>7 Press [SELECT] and set each item in the DETAIL EDIT window.</p>	<p>The DETAIL EDIT window appears.</p>  <p>Move the cursor to the item to be set and press [SELECT].</p>  <p>Use the Numeric keys to input the setting and press [ENTER].</p>  <p>The setting appears in the input buffer line.</p>

9.5 Registering Work Instructions

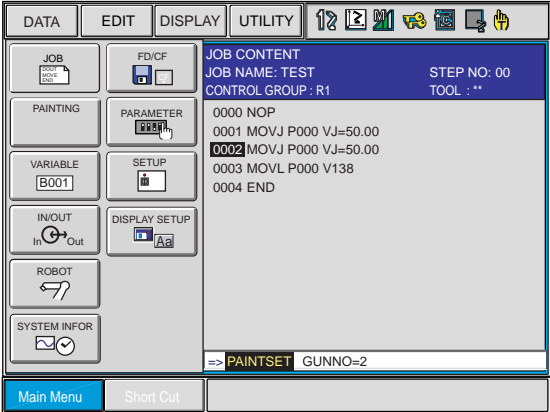
	Operation	Explanation
8	Press [ENTER].	<p>When [ENTER] is pressed, the setting is registered in the job.</p>  <p>The screenshot shows a control panel with several buttons: DATA, EDIT, DISPLAY, UTILITY, and a row of utility icons. Below these are buttons for JOB, PAINTING, VARIABLE, IN/OUT, ROBOT, and SYSTEM INFOR. The main display area is titled 'JOB CONTENT' and shows job details: JOB NAME: TEST, STEP NO: 00, CONTROL GROUP: R1, and TOOL: **. A list of instructions is displayed: 0000 NOP, 0001 MOVJ P000 VJ=50.00, 0002 MOVJ P000 VJ=50.00 (highlighted), 0003 MOVL P000 V138, and 0004 END. At the bottom, there is a status bar showing '=> PAINTSET GUNNO=2' and buttons for 'Main Menu' and 'Short Cut'.</p>

To cancel the setting, press [CANCEL]. The window returns to the JOB CONTENT window.

Syntax for the PAINTSET instruction

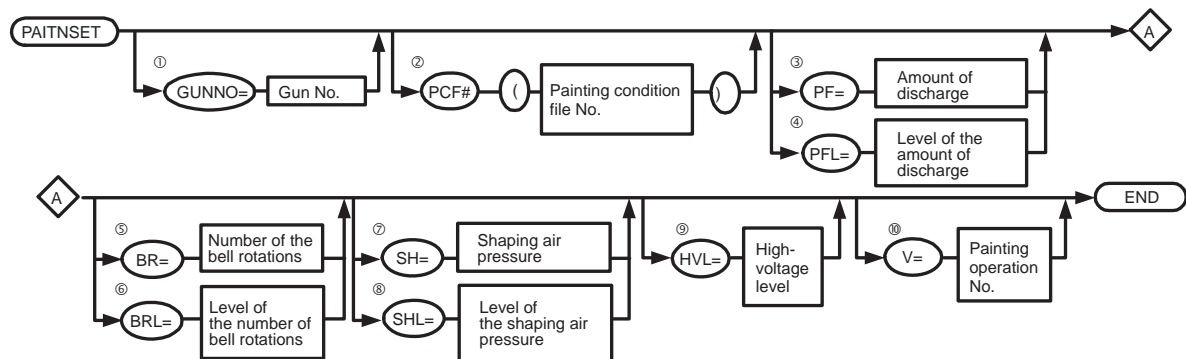

① Gun No. (Setting range: 1 to 3)

Controls the spray signal of the painting system characteristics setting file corresponding to the gun number.

If setting is omitted, 1 is applied for the gun number.

② Painting condition file No. (Setting range: 1 to 128)

Outputs the painting conditions for each setting in the painting condition file to the paint control panel.

③ Amount of discharge (Setting range: 0 to 999 [cc/min])

Outputs the setting for the amount of discharge to the paint control panel if the paint control panel is used to control the paint supplying device (when the paint supply that was set in the settings for the painting system is not connected).

④ Level of the amount of discharge (Setting range: 1 to 128)

Outputs the setting for the level of the amount of discharge to the paint control panel if the paint control panel is used to control the paint supplying device.

⑤ Number of the bell rotations (Setting range: 1 to 999 [krpm])

Outputs the data to the user output group that has been set in the painting system characteristics setting file.

⑥ Level of the number of bell rotations (Setting range: 1 to 128)

- If the output type of rotations in the painting system is set to "LEVEL":

Outputs the data to the user output that has been set in the painting system characteristics setting file.

- If the output type of rotations in the painting system is set to anything other than "LEVEL":

Does not function even if a setting is made.

⑦ Shaping air pressure (Setting range: 1 to 999 [kPa])

Outputs the data to the user output group that has been set in the painting system characteristics setting file.

⑧ Level of the shaping air pressure (Setting range: 1 to 128)

- If the shape output type in the painting system is set to "LEVEL":

Outputs the data to the user output that has been set in the painting system characteristics setting file.

- When the shape output type in the painting system is set to anything other than "LEVEL":

Does not function even if a setting is made.

⑨ **High-voltage level (Setting range: 1 to 3)**

Outputs the data to the user output group that has been set in the painting system characteristics setting file.

⑩ **Operation speed (Setting range: 0.1 to 1500.0 [mm/s])**

Sets the moving speed of the manipulator for a painting operation.
If the speed is not set in the move instruction in the PAINTSET section, the manipulator moves at the speed set here.



If each item (amount of discharge, revolutions, shape, high-voltage, operation speed) is set after the painting condition file number has been set, the settings in the painting condition file are disregarded and the latter settings become valid.

9.5.6 CALL

The CALL instruction is used to call a specified job.
This section describes an example where a job registration table is specified.

■ What Is the Job Registration Table?

In a job registration table, jobs that are read out by instructions such as the CALL instruction can be registered.

Three files are available for the job registration table. Each job registration table can hold 1024 jobs.

A job can be registered or edited in the job registration table even during play mode. The updated table becomes valid the next time when the job registration table is referred by instructions such as the CALL instruction.

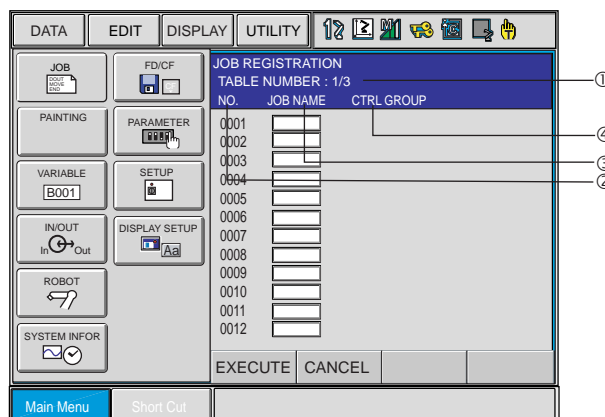

① **TABLE NUMBER (Setting range: 1 to 3)**

The job registration table number.

② **NO**

The job registration number.

③ **JOB NAME**

Sets the job name.

To call up the job list so that a job can be entered, press [SELECT].

To delete the registered job, press [ENTER] without selecting a job.

④ **CTRL GROUP**

Displays the control group of the selected job.

■ Registering the Job Registration Table

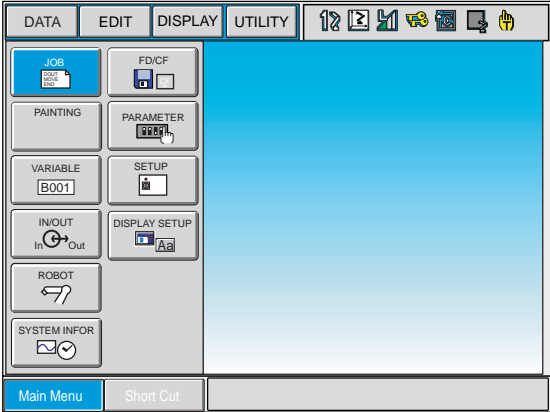
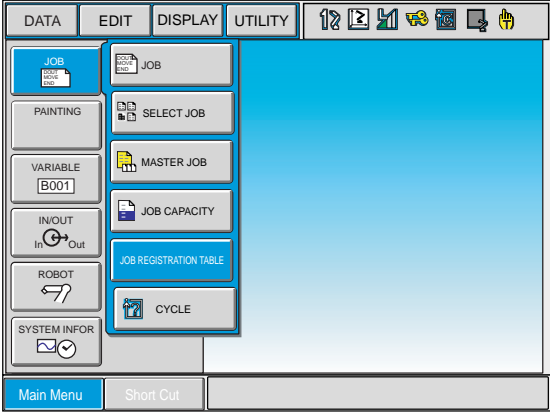

Be sure to edit the painting system characteristics setting file in management mode.

	Operation	Explanation																																													
1	Select {JOB} under the main menu.	 <p>The screenshot shows a software interface with a menu on the left and a main display area on the right. The menu items are: JOB (highlighted in blue), PAINTING, VARIABLE [B001], IN/OUT (In/Out), ROBOT, and SYSTEM INFOR. The main display area is currently blank.</p>																																													
2	Select {JOB REGISTRATION}.	 <p>The screenshot shows the 'JOB REGISTRATION' window. The menu on the left is the same as in the previous step, but the 'JOB REGISTRATION TABLE' option is now highlighted. The main display area shows a table with the following structure:</p> <table border="1" data-bbox="906 1599 1251 1890"> <thead> <tr> <th colspan="3">JOB REGISTRATION</th> </tr> <tr> <th colspan="3">TABLE NUMBER : 1/3</th> </tr> <tr> <th>NO.</th> <th>JOB NAME</th> <th>CTRL GROUP</th> </tr> </thead> <tbody> <tr><td>0001</td><td></td><td></td></tr> <tr><td>0002</td><td></td><td></td></tr> <tr><td>0003</td><td></td><td></td></tr> <tr><td>0004</td><td></td><td></td></tr> <tr><td>0005</td><td></td><td></td></tr> <tr><td>0006</td><td></td><td></td></tr> <tr><td>0007</td><td></td><td></td></tr> <tr><td>0008</td><td></td><td></td></tr> <tr><td>0009</td><td></td><td></td></tr> <tr><td>0010</td><td></td><td></td></tr> <tr><td>0011</td><td></td><td></td></tr> <tr><td>0012</td><td></td><td></td></tr> </tbody> </table> <p>At the bottom of the window, there are 'EXECUTE' and 'CANCEL' buttons.</p>	JOB REGISTRATION			TABLE NUMBER : 1/3			NO.	JOB NAME	CTRL GROUP	0001			0002			0003			0004			0005			0006			0007			0008			0009			0010			0011			0012		
JOB REGISTRATION																																															
TABLE NUMBER : 1/3																																															
NO.	JOB NAME	CTRL GROUP																																													
0001																																															
0002																																															
0003																																															
0004																																															
0005																																															
0006																																															
0007																																															
0008																																															
0009																																															
0010																																															
0011																																															
0012																																															

The JOB REGISTRATION window appears.

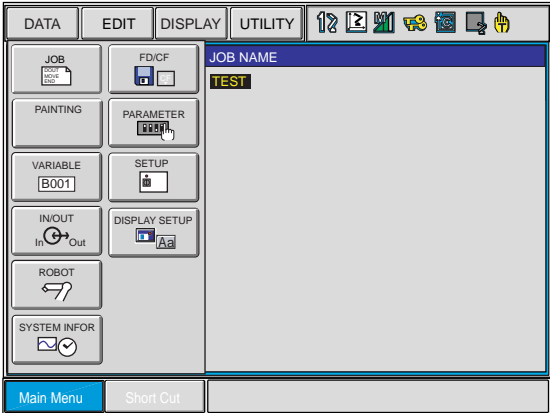
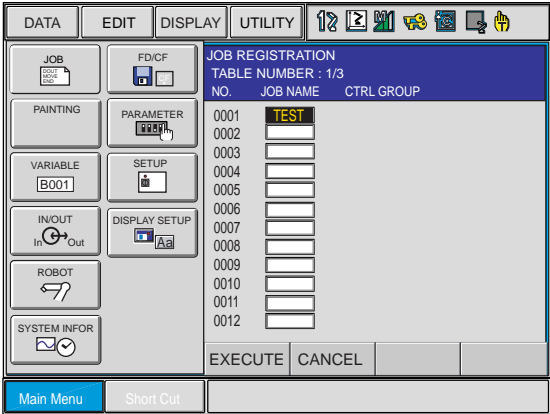
Operation	Explanation
<p>3 Press [SELECT] and set job data in the JOB NAME window.</p>	<p>The JOB NAME window appears.</p>  <p>Move the cursor to the job to be set and press [SELECT].</p>  <p>The setting appears in the window.</p>

■ Registering the CALL Instruction (JET)

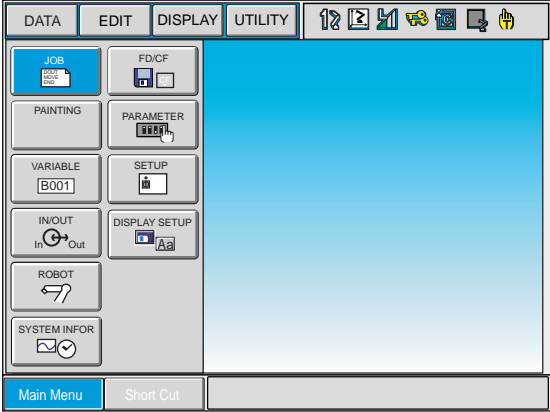
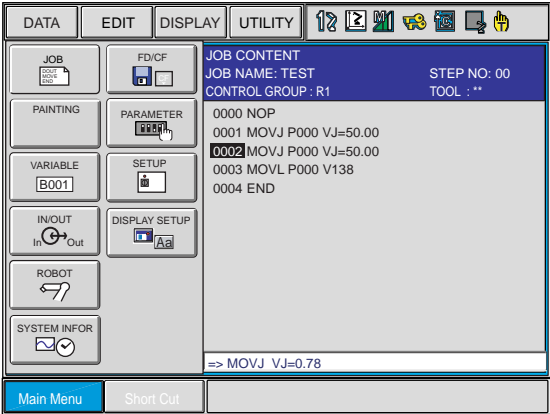
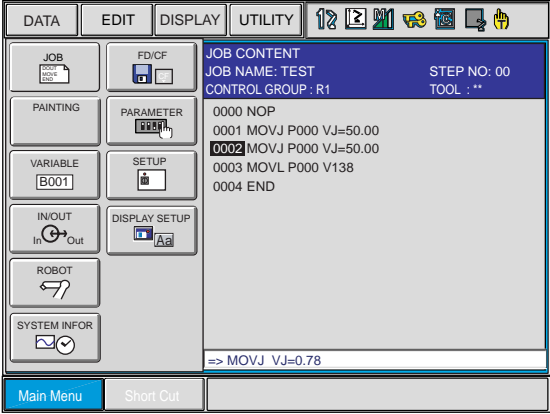
Operation	Explanation
<p>1 Select {JOB} under the main menu.</p>	
<p>2 Select {JOB}.</p>	<p>The JOB CONTENT window appears.</p> 
<p>3 Move the cursor to the address area.</p>	

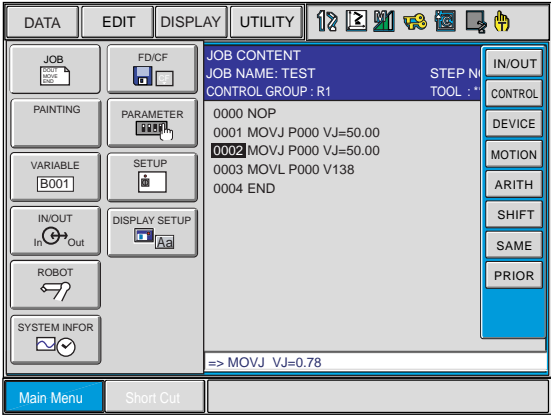
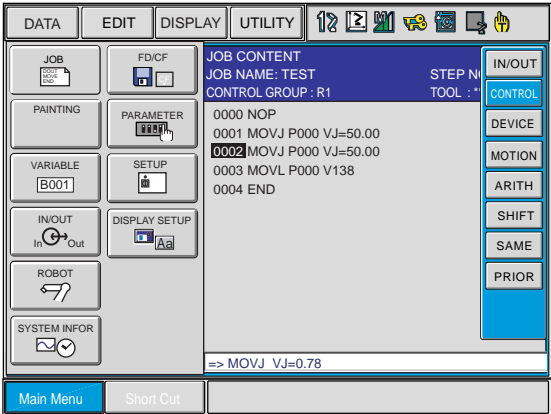
	Operation	Explanation
4	Press [INFORM LIST].	<p>The instruction list dialog box appears.</p> 
5	Select {CONTROL}.	

9.5 Registering Work Instructions

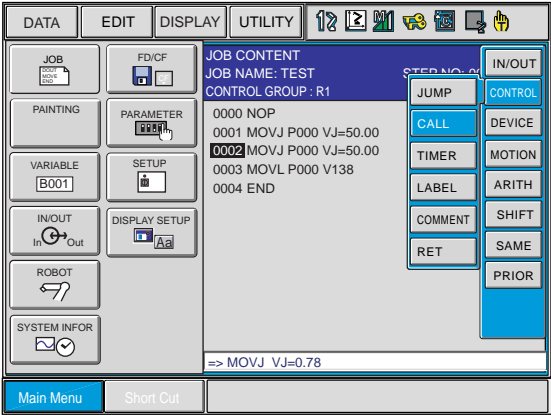
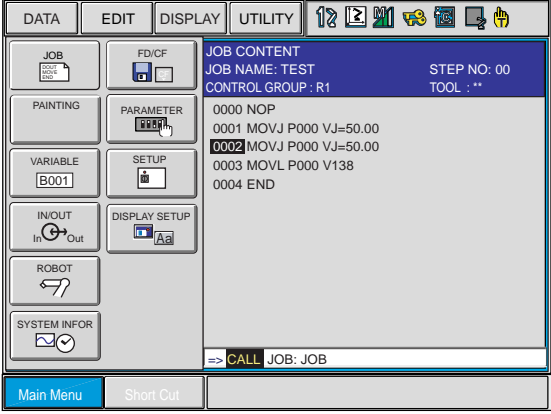
	Operation	Explanation
6	Select {CALL}.	 <p>The screenshot shows the 'JOB CONTENT' screen with the following details:</p> <ul style="list-style-type: none"> JOB NAME: TEST CONTROL GROUP: R1 STEP NO.: 00 TOOL: .. Program code: <pre> 0000 NOP 0001 MOVJ P000 VJ=50.00 0002 MOVJ P000 VJ=50.00 0003 MOVL P000 V138 0004 END </pre> Input buffer line: => MOVJ VJ=0.78 Right-hand menu: JUMP, CALL (highlighted), CONTROL, DEVICE, MOTION, ARITH, SHIFT, SAME, PRIOR.
		<p>"CALL" instruction appears in the input buffer line.</p>  <p>The screenshot shows the 'JOB CONTENT' screen with the following details:</p> <ul style="list-style-type: none"> JOB NAME: TEST CONTROL GROUP: R1 STEP NO.: 00 TOOL: .. Program code: <pre> 0000 NOP 0001 MOVJ P000 VJ=50.00 0002 MOVJ P000 VJ=50.00 0003 MOVL P000 V138 0004 END </pre> Input buffer line: => CALL JOB: JOB

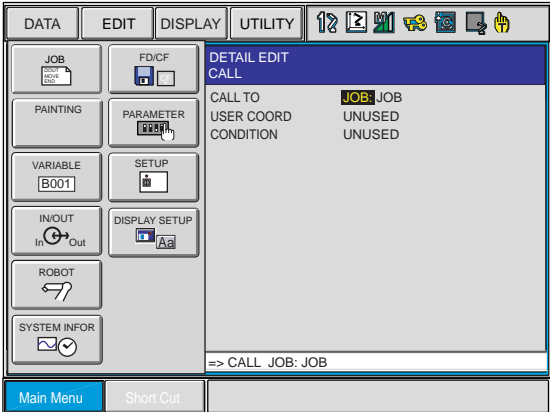
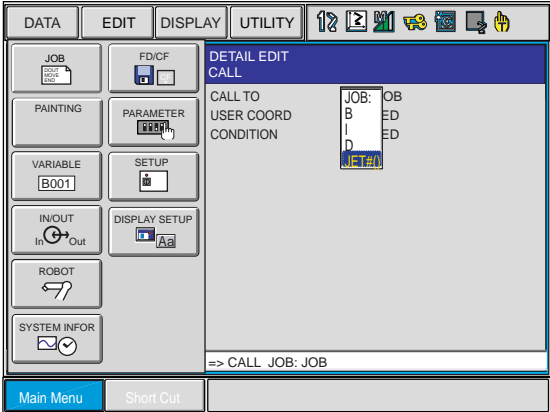
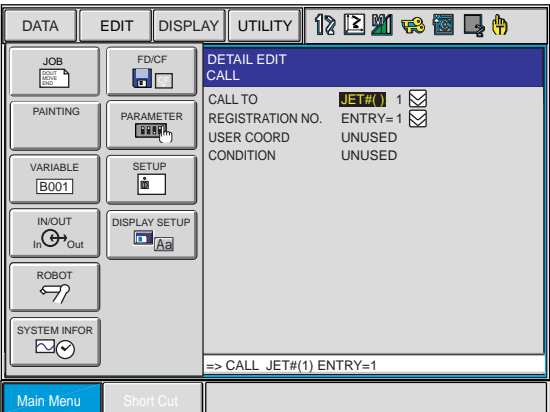
Operation	Explanation
<p>7 Press [SELECT] and set each item in the DETAIL EDIT window.</p>	<p>The DETAIL EDIT window appears.</p>  <p>Move the cursor to the item to be set and press [SELECT]. (For the CALL destination, select {JET}.)</p>  <p>Use the Numeric keys to input the setting and press [ENTER].</p>  <p>The setting appears in the input buffer line.</p>

9.5 Registering Work Instructions

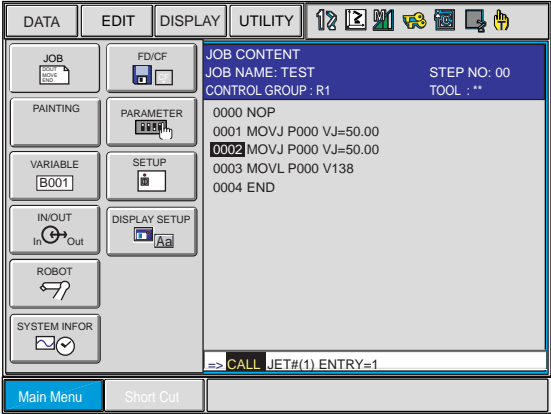
	Operation	Explanation
8	Press [ENTER].	<p>When [ENTER] is pressed, the setting is registered in the job.</p>  <p>To cancel the setting, press [CANCEL]. The window returns to the JOB CONTENT window.</p>

Syntax for the CALL instruction

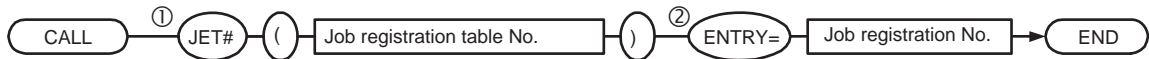

① **Job registration table No. (Setting range: 1 to 3)**

Sets the job registration table number.

② **Job registration No. (Setting range: 1 to 1024)**

Sets the registration number of the job that is registered in a specified job registration table.

Example of CALL Job

Line	Instruction	Description
0000	NOP	
0001	WAIT IN#(1)=ON	Waits for a start signal to be input.
0002	DIN B000 OG#(2)	Enter the job registration number.
0003	CALL JET#(1) ENTRY=B000	Calls the job corresponding to the registration number that is entered in B000.
0004	PULSE OT#(1) T=1.00	Outputs the work end signal in pulses.
0005	END	
0006	MOVL V=100	

9.6 Painting Condition File

A painting condition file is a file in which the painting conditions are registered.

Use this file to make the setting and correction of the painting instructions easier.

The internal memory of the NX100 can usually hold 128 painting condition files. One painting condition package can contain 128 painting condition files.

The PAINTSET instruction is used to make the settings for a painting condition file.

9.7 Managing Painting Condition Files

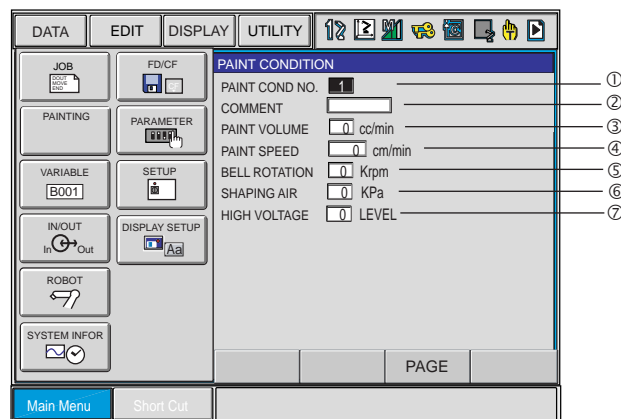

① **CONDITION NO. (Setting range: 1 to 128)**

Displays the painting condition number.

② **COMMENT**

Maximum eight characters.

③ **PAINT VOLUME**

Sets the amount of paint to be discharged. The setting is made in units of cc/min or by levels, depending on the connected device that is registered in the settings for the painting system.*1

④ **PAINT SPEED**

Sets the moving speed of the manipulator in a painting operation.

⑤ **BELL ROTATION**

Sets the number of the bell rotations of the bell gun. The setting is made in units of krpm or by levels, depending on the connected device that is registered in the settings for the painting system.*2

⑥ **SHAPING AIR**

Sets the shaping air pressure of the bell gun. The setting is made in units of kPa or by levels, depending on the connected device that is registered in the settings for the painting system.*3

⑦ HIGH VOLTAGE

Sets the high voltage of the bell gun. The setting is made by levels.

- *1** The setting for the amount of discharge differs depending on the type of the supply section that was registered in the settings for the painting system.
 - When the supply section is set to “UNUSED”:
The amount of discharge is set by levels.
 - When the supply section is set to “FGP”:
The amount of discharge is set in units of cc/min.
- *2** The setting for the number of the bell rotations differs depending on the number of rotations to be output that was registered in the settings for the painting system.
 - When the number of rotations to be output is set to “I/O OUTPUT”:
The number of bell rotations is set in units of krpm.
 - When the number of rotations to be output is set to “LEVEL”:
The number of bell rotations is set by levels.
- *3** The setting for the shaping air pressure differs depending on the shape output that was registered in the settings for the painting system.
 - When the shape output is set to “I/O OUTPUT”:
The shaping air pressure is set in units of kpa.
 - When the shape output is set to “LEVEL”:
The shaping air pressure is set by levels.

9.8 Editing Painting Condition Files

9.8.1 Calling Up Painting Condition Files

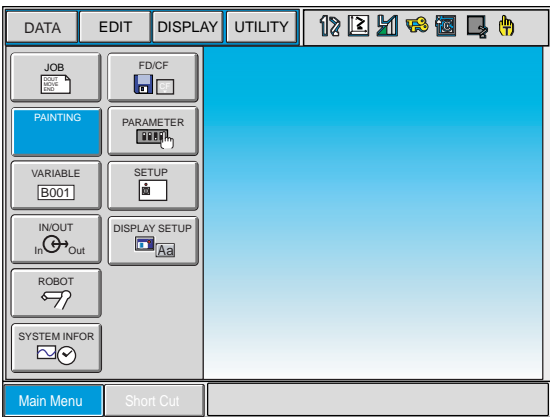
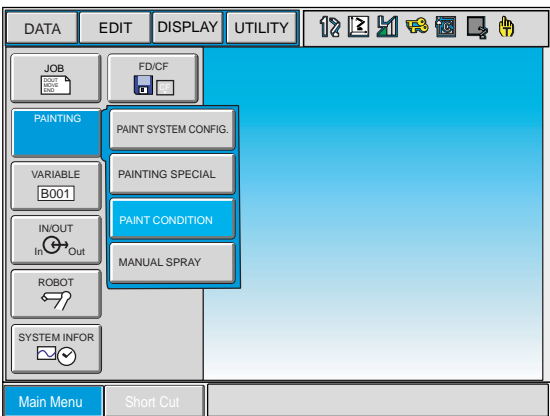
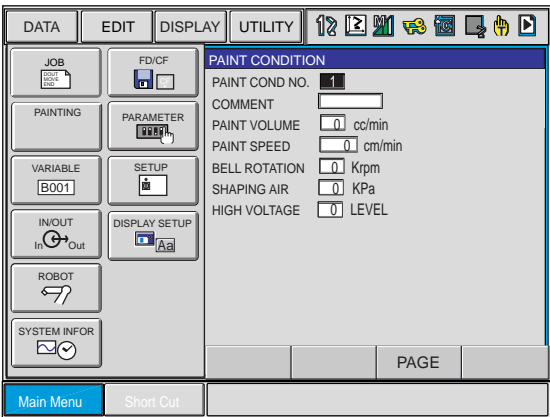
Operation	Explanation
<p>1 Select {PAINTING} under the main menu.</p>	 <p>The screenshot shows a software interface with a menu bar (DATA, EDIT, DISPLAY, UTILITY) and a toolbar. A central menu is open, listing options: JOB, PAINTING (highlighted in blue), VARIABLE, IN/OUT, ROBOT, and SYSTEM INFOR. To the right, there are sub-menus for FDI/CF, PARAMETER, SETUP, and DISPLAY SETUP. At the bottom, there are 'Main Menu' and 'Short Cut' buttons.</p>
<p>2 Select {PAINT CONDITION}.</p>	 <p>The screenshot shows the same main menu, but the PAINTING option is selected, and a sub-menu is displayed with options: PAINT SYSTEM CONFIG., PAINTING SPECIAL, PAINT CONDITION (highlighted in blue), and MANUAL SPRAY.</p> <p>The PAINT CONDITION window appears.</p>  <p>The screenshot shows the PAINT CONDITION window with the following parameters:</p> <ul style="list-style-type: none"> PAINT COND NO. [1] COMMENT [] PAINT VOLUME [0] cc/min PAINT SPEED [0] cm/min BELL ROTATION [0] Krpm SHAPING AIR [0] KPa HIGH VOLTAGE [0] LEVEL <p>At the bottom of the window, there are 'Main Menu' and 'Short Cut' buttons, and a 'PAGE' indicator.</p>

9.8.2 Registering Painting Condition Files

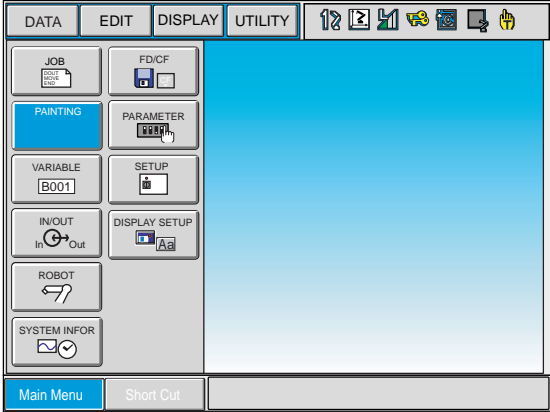
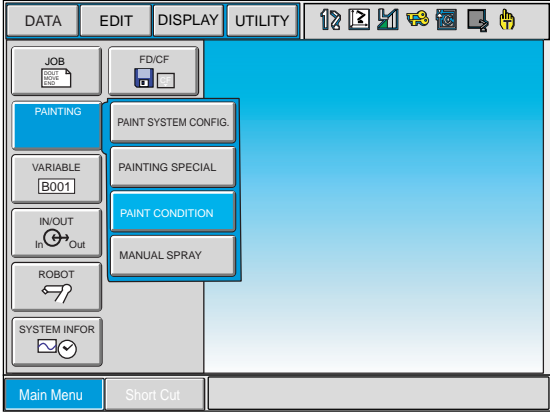
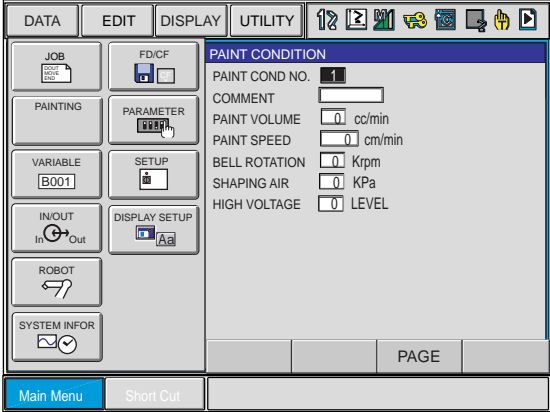
	Operation	Explanation
1	Select {PAINTING} under the main menu.	 <p>The screenshot shows a software interface with a top menu bar containing 'DATA', 'EDIT', 'DISPLAY', and 'UTILITY'. Below this is a grid of function buttons: 'JOB', 'FD/CF', 'PAINTING', 'PARAMETER', 'VARIABLE [B001]', 'SETUP', 'IN/OUT', 'DISPLAY SETUP', 'ROBOT', and 'SYSTEM INFOR'. The 'PAINTING' button is highlighted in blue. At the bottom, there are 'Main Menu' and 'Short Cut' buttons.</p>
2	Select {PAINT CONDITION}.	<p>The PAINT CONDITION window appears.</p>  <p>The screenshot shows the same main menu as above, but with a sub-menu open over the 'PAINTING' button. The sub-menu options are 'PAINT SYSTEM CONFIG.', 'PAINTING SPECIAL', 'PAINT CONDITION', and 'MANUAL SPRAY'. The 'PAINT CONDITION' option is highlighted in blue.</p>
3	Move the cursor to the address area.	 <p>The screenshot shows the 'PAINT CONDITION' window. The title bar reads 'PAINT CONDITION'. The content area contains several fields: 'PAINT COND NO.' with the value '1', 'COMMENT', 'PAINT VOLUME' (0 cc/min), 'PAINT SPEED' (0 cm/min), 'BELL ROTATION' (0 Krpm), 'SHAPING AIR' (0 KPa), and 'HIGH VOLTAGE' (0 LEVEL). A 'PAGE' button is visible at the bottom right of the window. The 'PAINTING' button in the main menu is still highlighted.</p>

9.8 Editing Painting Condition Files

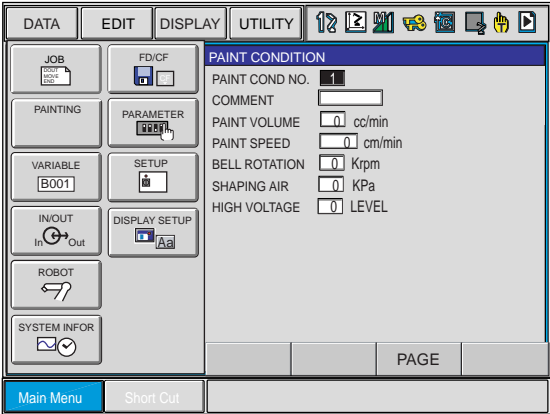
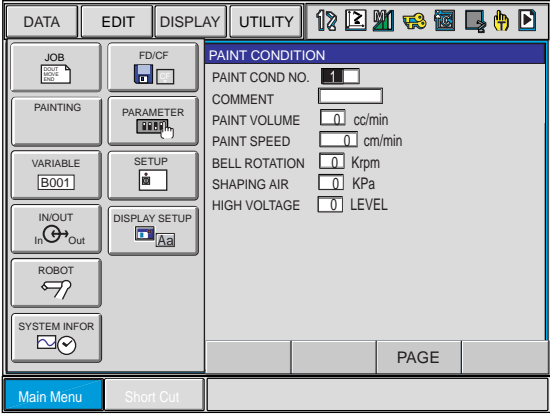
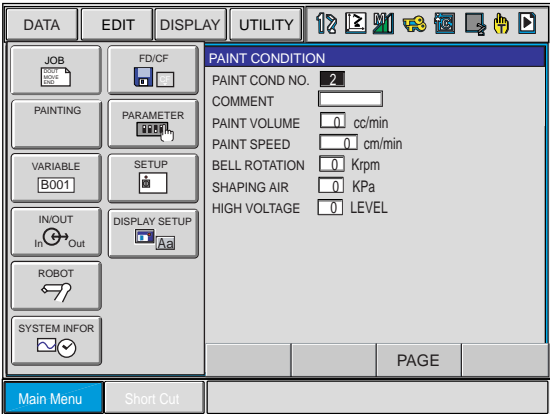
Operation	Explanation
<p>4 Set each item in the PAINT CONDITION window.</p>	<p>Move the cursor to the item to be set and press [SELECT].</p>  <p>Use character input keys and the Numeric keys to input the setting and press [ENTER].</p> 
<p>5 Press [ENTER].</p>	<p>When [ENTER] is pressed, the setting is registered in the painting condition file.</p>  <p>To cancel the setting, press [CANCEL]. The window returns to the JOB CONTENT window.</p>

9.9 Painting System Setting File

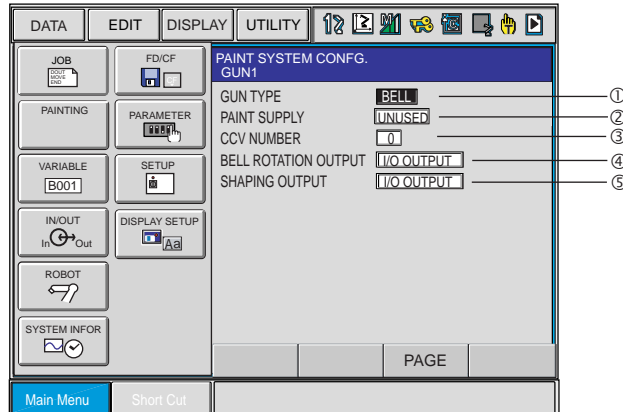

① GUN TYPE

Sets the gun type.

“SPRAY” or “BELL” can be selected.

② PAINT SUPPLY

Sets the paint supplying device.

“UNUSED” or “FGP” can be selected, however, normally select “UNUSED.”

- When “UNUSED” is selected

The paint supplying device is controlled by the paint control panel. Therefore, control of the amount of discharge from the NX100 is controlled by the I/O output.

- When “FGP” is selected

The paint supplying device, FGP, is controlled by the NX100. The amount of discharge is controlled by the servo.

③ CCV NUMBER (Setting range: 0 to 52)

Sets the number of CCVs (the number of painting colors) to be connected. When a CCV is connected to the paint control panel, set the CCV number to zero.

④ BELL ROTATION OUTPUT

Sets the output method to control the number of bell rotations.

“I/O OUTPUT,” “LEVEL,” “CURRENT,” “VOLTAGE (0 - 5V),” or “VOLTAGE (0 - 10V)” can be selected.

- When “I/O OUTPUT” is selected

The paint control panel controls the number of bell rotations. The set number of bell rotations (krpm) is output for the output bit specified in the painting system characteristics setting file.

- When “LEVEL” is selected

The paint control panel controls the number of bell rotations. The level value that was set is output for the output bit specified in the painting system characteristics setting file.

⑤ **SHAPING OUTPUT**

Sets the output method to control shaping.

“I/O OUTPUT,” “LEVEL,” “CURRENT,” “VOLTAGE (0 - 5V),” or “VOLTAGE (0 - 10V)” can be selected.

- When “I/O OUTPUT” is selected

The paint control panel controls shaping. The shaping air pressure (kPa) that was set is output for the output bit specified in the painting system characteristics setting file.

- When “LEVEL” is selected

The paint control panel controls shaping. The level value that was set is output for the output bit specified in the painting system characteristics setting file.

9.9.1 Calling Up Painting System Setting Files

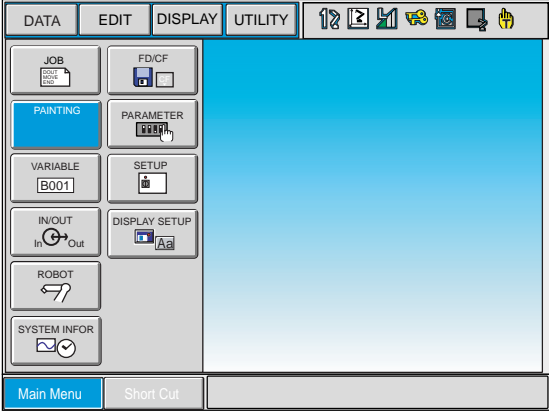
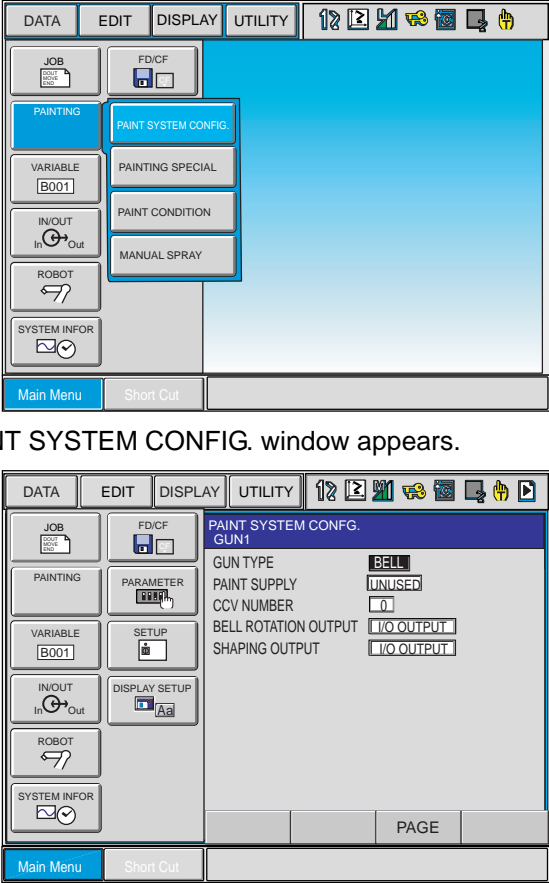
	Operation	Explanation
1	Select {PAINTING} under the main menu.	
2	Select {PAINT SYSTEM CON-FIG.}.	 <p>The PAINT SYSTEM CONFIG. window appears.</p>

9.9.2 Editing Painting System Setting Files

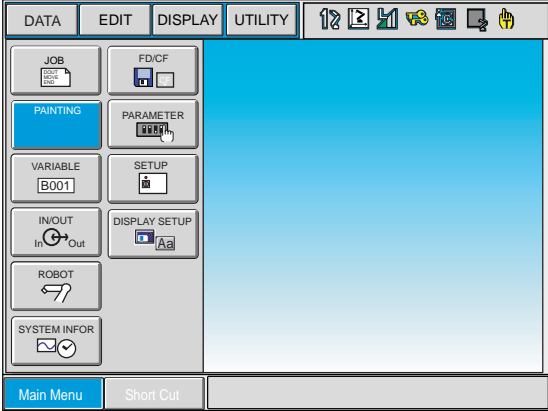
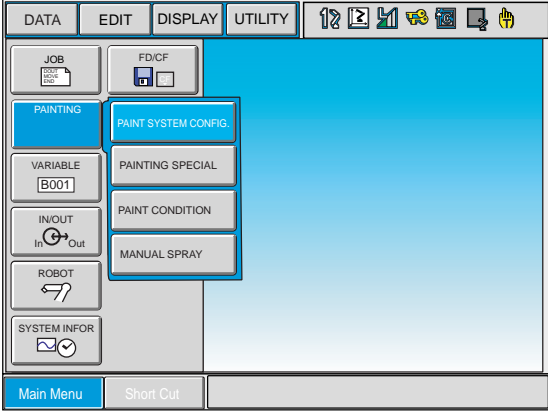

Be sure to edit the painting system setting file in management mode.

	Operation	Explanation
1	Select {PAINTING} under the main menu.	 <p>The screenshot shows a software interface with a menu bar (DATA, EDIT, DISPLAY, UTILITY) and a toolbar. The main menu is displayed with several options: JOB, FD/CF, PAINTING (highlighted in blue), PARAMETER, VARIABLE (B001), SETUP, IN/OUT, DISPLAY SETUP, ROBOT, and SYSTEM INFOR. At the bottom, there are 'Main Menu' and 'Short Cut' buttons.</p>
2	Select {PAINT SYSTEM CONFIG.}.	<p>The PAINT SYSTEM CONFIG. window appears.</p>  <p>The screenshot shows the same main menu as above, but with a sub-menu open under the PAINTING option. The sub-menu contains: PAINT SYSTEM CONFIG. (highlighted in blue), PAINTING SPECIAL, PAINT CONDITION, and MANUAL SPRAY. The rest of the interface remains the same.</p>

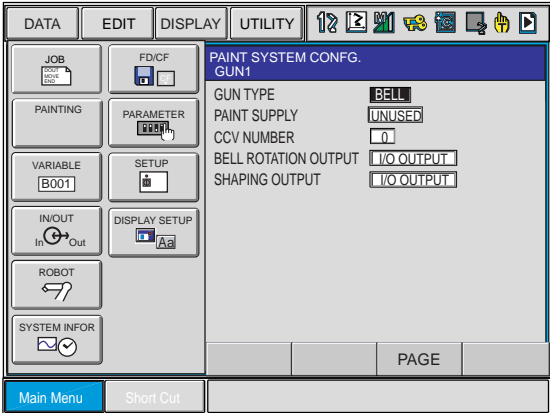
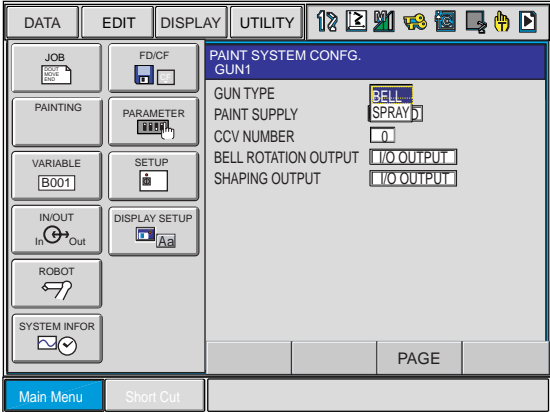
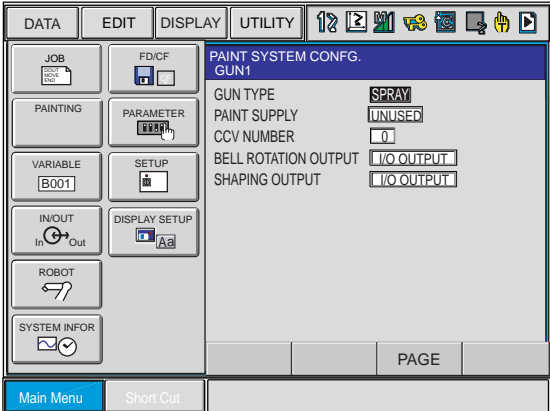
	Operation	Explanation
3	Move the cursor to the address area.	
4	Set each item in the PAINT SYSTEM CONFIG. window.	<p data-bbox="662 779 1358 808">Move the cursor to the item to be set and press [SELECT].</p>  <p data-bbox="662 1243 1422 1305">Use character input keys and the Numeric keys to input the setting and press [ENTER].</p>
5	Press [ENTER].	<p data-bbox="662 1323 1434 1379">When [ENTER] is pressed, the setting is registered in the painting system setting file.</p>  <p data-bbox="662 1816 1434 1872">To cancel the setting, press [CANCEL]. The window returns to the JOB CONTENT window.</p>

9.10 Painting System Characteristics Setting File

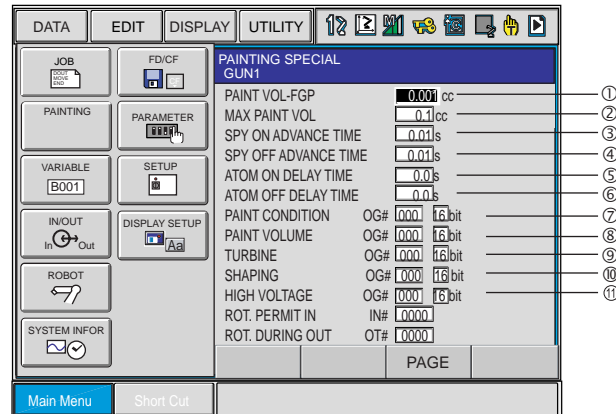

① PAINT VOL-FGP

The setting differs depending on the gun type registered in the settings for the painting system.

- When “UNUSED” is selected
The setting does not affect the manipulator’s motion.
- When “FGP” is selected
The FGP capacity (the amount of discharge per rotation) is set in units of cc.

② MAX PAINT VOL

The setting differs depending on the gun type registered in the settings for the painting system.

- When “UNUSED” is selected
The setting does not affect the manipulator’s motion.
- When “FGP” is selected
The maximum allowable amount of discharge of FGP is set in units of cc.

③ SPY ON ADVANCE TIME

Sets the shifting time of the advanced signal output for when the spray signal is turned ON. The advance time for outputting spray is set in the register corresponding to the number of the gun when the SPYON instruction is carried out.

④ SPY OFF ADVANCE TIME

Sets the shifting time of the advanced signal output for when the spray signal is turned OFF. The advance time for outputting spray is set in the register corresponding to the gun number when the SPYOF instruction is carried out.

⑤ ATOM ON DELAY TIME

Sets the timing of the advanced signal output for turning ON the atomization pressure signal for when the spray signal is turned ON, and the timing of the delayed signal output for turning OFF the atomization pressure signal for when the spray signal is turned OFF.

When the SPYON instruction is carried out, the delay time of the atomization pressure signal is set in the register corresponding to the number of the gun.

⑥ ATOM OFF DELAY TIME

Sets the timing of the advanced signal output for turning ON the atomization pressure signal for when the spray signal is turned ON, and the timing of the delayed signal output for turning OFF the atomization pressure signal for when the spray signal is turned OFF.

When the SPYOF instruction is carried out, the delay time of the atomization pressure signal is set in the register corresponding to the number of gun.

⑦ PAINT CONDITION OUTPUT DESTINATION

Sets the output destination of the painting conditions and also the number of output bits.

⑧ PAINT VOLUME OUTPUT DESTINATION

Sets the output destination of the amount of discharge and also the number of output bits.

⑨ TURBINE

Sets the output destination of the number of rotations (turbine) and also the number of output bits.

- When "I/O OUTPUT" is selected

Sets the output destination of the number of bell rotations and also the number of output bits.

- When "LEVEL" is selected

Sets the output destination of the level of the number of bell rotations and also the number of output bits.

⑩ SHAPING

Sets the output destination of the shape (pattern) and also the number of output bits.

- When "I/O OUTPUT" is selected

Sets the output destination of the shaping and also the number of output bits.

- When "LEVEL" is selected

Sets the destination of the shaping level and also the number of output bits.

⑪ HIGH VOLTAGE

Sets the output destination of high voltage and also the number of output bits.

9.10.1 Editing Painting System Characteristics Setting Files

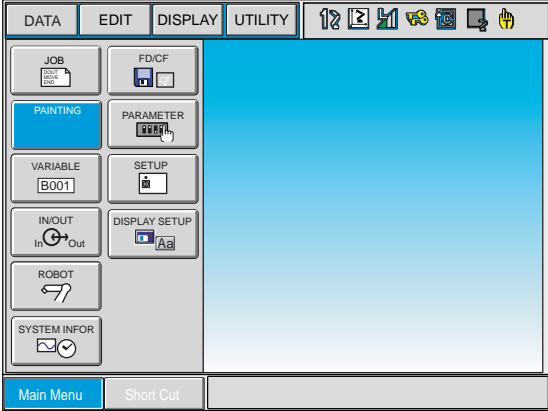
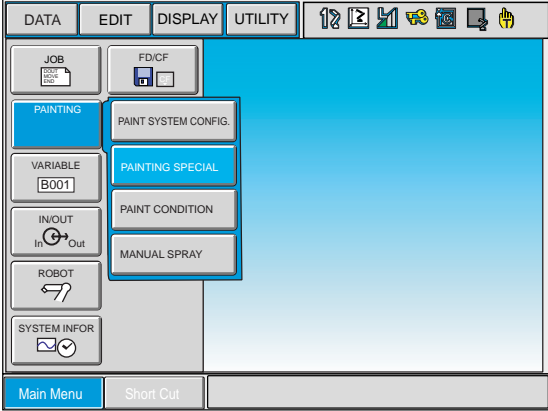

Be sure to edit the painting system characteristics setting file in management mode.

	Operation	Explanation
1	Select {PAINTING} under the main menu.	 <p>The screenshot shows a software interface with a menu bar (DATA, EDIT, DISPLAY, UTILITY) and a toolbar. The main menu is displayed with several options: JOB, FD/CF, PAINTING (highlighted in blue), PARAMETER, VARIABLE B001, SETUP, IN/OUT, DISPLAY SETUP, ROBOT, and SYSTEM INFOR. At the bottom, there are buttons for 'Main Menu' and 'Short Cut'.</p>
2	Select {PAINTING SPECIAL}.	<p>The PAINTING SPECIAL window appears.</p>  <p>The screenshot shows the same main menu as above, but the 'PAINTING' option is expanded to show a sub-menu with the following items: PAINT SYSTEM CONFIG, PAINTING SPECIAL (highlighted in blue), PAINT CONDITION, and MANUAL SPRAY. The 'Main Menu' and 'Short Cut' buttons remain at the bottom.</p>

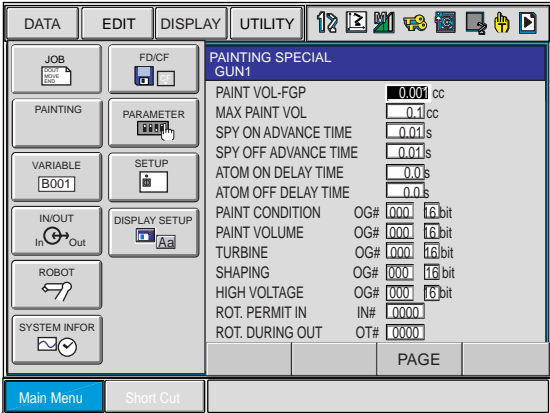
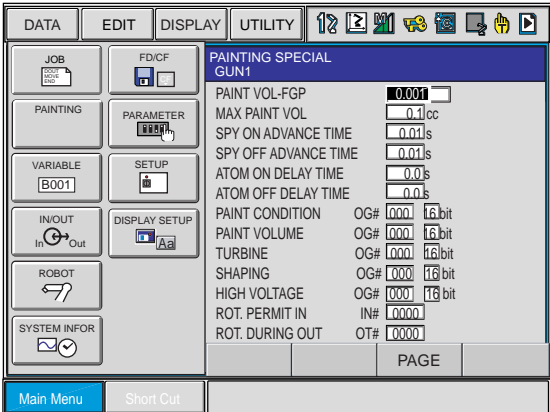
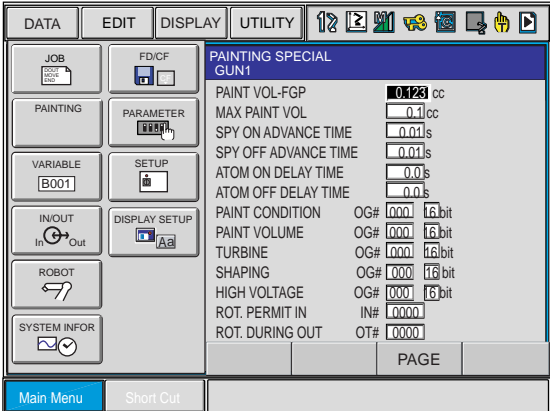
	Operation	Explanation
3	Move the cursor to the address area.	 <p>The screenshot shows the 'PAINTING SPECIAL GUN1' window with various parameters. The 'PAINT VOL-FGP' parameter is highlighted with a cursor, and its value '0.001' is shown in a text box. Other parameters include MAX PAINT VOL, SPY ON ADVANCE TIME, SPY OFF ADVANCE TIME, ATOM ON DELAY TIME, ATOM OFF DELAY TIME, PAINT CONDITION, PAINT VOLUME, TURBINE, SHAPING, HIGH VOLTAGE, ROT. PERMIT IN, and ROT. DURING OUT.</p>
4	Set each item in the PAINTING SPECIAL window.	<p>Move the cursor to the item to be set and press [SELECT].</p>  <p>The screenshot shows the 'PAINTING SPECIAL GUN1' window with the cursor positioned over the '0.001' value for PAINT VOL-FGP. The value is now enclosed in a text box, indicating it is ready for input.</p> <p>Use character input keys and the Numeric keys to input the setting and press [ENTER].</p>
5	Press [ENTER].	<p>When [ENTER] is pressed, the setting is registered in the painting system characteristics setting file.</p>  <p>The screenshot shows the 'PAINTING SPECIAL GUN1' window with the value '0.0123' entered for PAINT VOL-FGP. The cursor is now positioned at the end of the value.</p> <p>To cancel the setting, press [CANCEL]. The window returns to the JOB CONTENT window.</p>



If the gun type setting is BELL in a painting system setting file, "ATOM ON DELAY TIME" and "ATOM OFF DELAY TIME" in a painting system characteristics setting file is not displayed in the window.

9.10.2 ON Timing of the Work Start Instruction for the SPYON Instruction

The graph shows the ON timing of the work start instruction of the Specific Output Signals when the SPYON instruction is carried out. The ON timing depends on the relationship between the anticipation time of the SPYON instruction, the advance time for turning ON the spray, and the delay time for turning ON the atomizing.

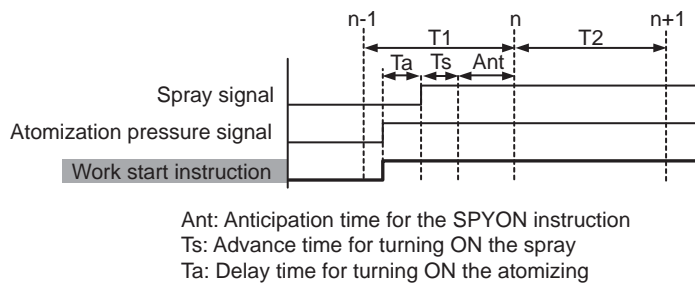

9.10.3 OFF Timing of the Work Start Instruction for the SPYOF Instruction

The graph shows the OFF timing of the work start instruction of the Specific Output Signals when the SPYOF instruction is carried out. The OFF timing depends on the relationship between the anticipation time of the SPYOF instruction, the advance time for turning OFF the spray, and the delay time for turning OFF the atomizing.

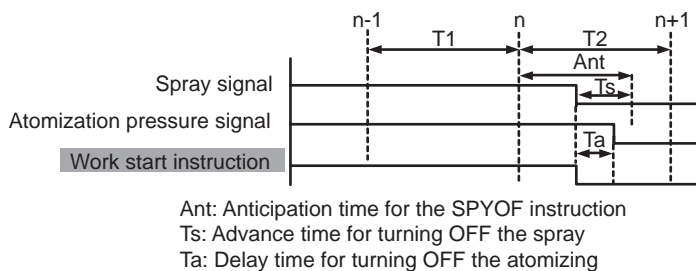

9.10.4 Notes on the ON/OFF Timing of the Work Start Instruction

When Executing the SPYON Instruction

- If the total of the anticipation time, the advance time for turning ON the spray, and the delay time for turning ON the atomizing of the SPYON instruction that has been set is longer than the time required by the manipulator to reach step n from step $n-1$, the timing of when the work start instruction turns ON can be explained by the following graph.

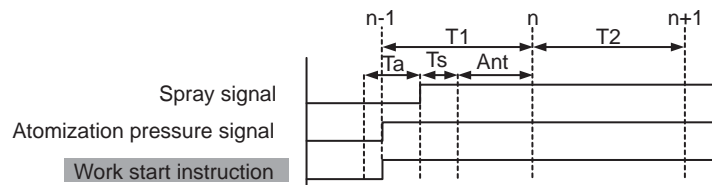

- If the total of the anticipation time, the advance time for turning ON the spray, and the delay time for turning ON the atomizing of the SPYON instruction that has been set is longer than the time required by the manipulator to reach step $n+1$ from step n , the timing of when the work start instruction turns ON can be explained by the following graph.

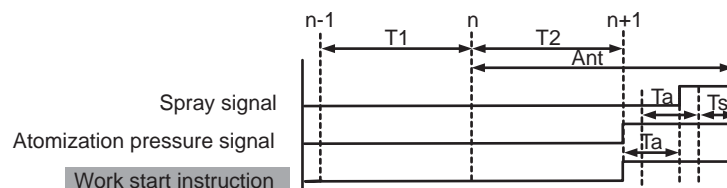

When Executing the SPYOF Instruction

- If the total of the anticipation time, the advance time for turning OFF the spray, and the delay time for turning OFF the atomizing of the SPYOF instruction that has been set is longer than the time required by the manipulator to reach step n from step $n-1$, the timing of when the work start instruction turns OFF can be explained by the following graph.

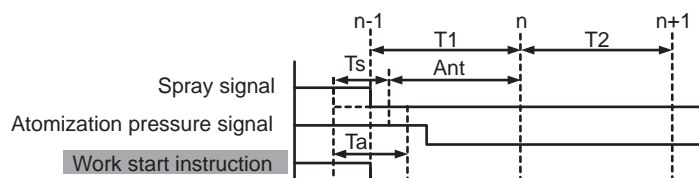

- If the total of the anticipation time, the advance time for turning OFF the spray, and the delay time for turning OFF the atomizing of the SPYOF instruction that has been set is longer than the time required by the manipulator to reach step $n+1$ from step n , the timing of when the work start instruction turns OFF can be explained by the following graph.

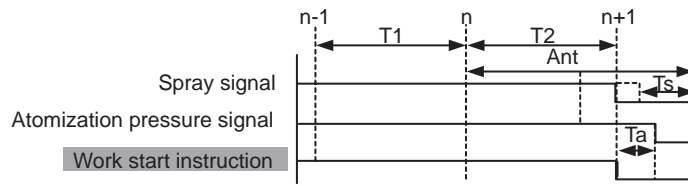

If NWAIT is not added to the move instruction before the SPYON/SPYOFF instruction, the anticipation output function is not executed. Therefore, spray ON/OFF cannot be controlled at the accurate timing.

Be sure to add NWAIT to the move instruction before the SPYON/SPYOFF instruction so that spray ON/OFF timing can be controlled accurately.

9.11 Work Instruction List

The following table lists the instructions related to the painting application.

- The parentheses indicate data such as alphanumeric characters.
- For instructions which have more than one item in one frame, select only one.

Painting Instruction

SPYON (Spray ON)	Function	Turns ON the work start instruction of the Specific Output Signals for the specified painting gun.	
	Item	GUNNO = (Gun No.)	1 to 4 Applied when several guns are provided.
		ANT = (Anticipation time)	-327.68 to 327.67 seconds
	Example of Use	SPYON SPYON GUNNO=2 SPYON ANT=1.00 SPYON GUN=1 ANT=-2.00	
SPYOF (Spray OFF)	Function	Turns OFF the work start instruction of the Specific Output Signals for the specified painting gun.	
	Item	GUNNO = (Gun No.)	1 to 4 Applied when several guns are provided
		ANT = (Anticipation time)	-327.68 to 327.67 seconds
	Example of Use	SPYOF SPYOF GUNNO=2 SPYOF ANT=1.00 SPYOF GUN=1 ANT=-2.00	

PAINTSET (Paint Set)	Function	Sets the painting conditions for the paint control panel.	
	Item	GUNNO = (Gun No.)	1 to 4 Applied when several guns are provided.
		PCF# ((Painting condition file No.))	1 to 128
		PF = (Amount of discharge)	0 to 999 cc/min
		PFL = (Level for the amount of discharge)	1 to 128
		BR = (Number of bell rotations)	0 to 999 krpm
		BRL = (Level of number of bell rotations)	1 to 128
		SH = (Shaping air pressure)	0 to 999 kPa
		SHL = (Level of shaping air pressure)	1 to 128
		HVL = (Level of high voltage)	0 to 3
		PV = (Painting operation speed)	0.1 to 1500.0 mm/s
Example of Use	PAINTSET PCF#(1) PAINTSET PF=200 BR=500 SH=500 PAINTSET PCF#(100) PV=1000		

10 Table of Basic Instructions

- <> indicates numerical or alphabetical data.
- If multiple items are shown in one section, select one of the items.

10.1 Move Instructions

MOVJ	Function	Moves to a taught point with joint interpolation type.	
	Additional Item	Position data, Base axis position data, Station axis position data	These data do not appear on the screen.
		VJ=<play speed>	VJ: 0.01 to 100.00%
		PL=<position level>	PL:0 to 8
		NWAIT	
		UNTIL statement	
		ACC=(acceleration adjustment ratio)	ACC: 20 to 100%
		DEC=(deceleration adjustment ratio)	DEC: 20 to 100%
Example	MOVJ VJ=50.00 PL=2 NWAIT UNTIL IN#(16)=ON		

10.1 Move Instructions

MOVL	Function	Moves to a taught point with linear interpolation type.	
	Additional Item	Position data, Base axis position data, Station axis position data	These data do not appear on the screen.
		V=<play speed>, VR=<play speed of the posture>, VE=<play speed of external axis>	V:0.1 to 1500.0 mm/s 1 to 9000.0 cm/min VR:0.1 to 180.0 deg/s VE:0.01 to 100.00%
		PL=<position level>	PL:0 to 8
		CR=(corner radius)	CR: 1.0 to 6553.5mm
		NWAIT	
		UNTIL statement	
		ACC=(acceleration adjustment ratio)	ACC: 20 to 100%
		DEC=(deceleration adjustment ratio)	DEC: 20 to 100%
Example	MOVL V=138 PL=0 NWAIT UNTIL IN#(16)=ON		
MOV C	Function	Moves to a taught point with circular interpolation type.	
	Additional Item	Position data, Base axis position data, Station axis position data	These data do not appear on the screen.
		V=<play speed>, VR=<play speed of the posture>, VE=<play speed of external axis>	Same as MOVL.
		PL=<position level>	PL:0 to 8
		NWAIT	
		ACC=(acceleration adjustment ratio)	ACC: 20 to 100%
		DEC=(deceleration adjustment ratio)	DEC: 20 to 100%
	Example	MOV C V=138 PL=0 NWAIT	

MOVS	Function	Moves to a taught point with spline interpolation type.	
	Additional Item	Position data, Base axis position data, Station axis position data	These data do not appear on the screen.
		V=<play speed>, VR=<play speed of the posture>, VE=<play speed of external axis>	Same as MOVL.
		PL=<position level>	PL:0 to 8
		NWAIT	
		ACC=(acceleration adjustment ratio)	ACC: 20 to 100%
		DEC=(deceleration adjustment ratio)	DEC: 20 to 100%
Example	MOVS V=120 PL=0		
IMOV	Function	Moves the specified increment from the current position with linear interpolation type.	
	Additional Item	P<variable number>, BP<variable number>, EX<variable number>	
		V=<play speed>, VR=<play speed of the posture>, VE=<play speed of external axis>	Same as MOVL.
		PL=<position level>	PL:0 to 8
		NWAIT	
		BF,RF,TF,UF# (<user coordinate number>)	BF: base coordinates RF: robot coordinates TF: tool coordinates UF: user coordinates
		UNTIL statement	
		ACC=(acceleration adjustment ratio)	ACC: 20 to 100%
		DEC=(deceleration adjustment ratio)	DEC: 20 to 100%
		Example	IMOV P000 V=138 PL=1 RF

10.1 Move Instructions

REFP	Function	Defines a reference point (e.g. wall point for weaving).	
	Additional Item	<reference point number>	wall point 1 for weaving :1 wall point 2 for weaving :2
		Position data, Base axis position data, Station axis position data	These data do not appear on the screen.
	Example	REFP 1	
SPEED	Function	Sets play speed.	
	Additional Item	VJ=<joint speed>, V=<TCP speed>, VR=<play speed of the posture>, VE=<play speed of external axis>	VJ:Same as MOVJ. V,VR,VE: Same as MOVL.
	Example	SPEED VJ=50.00	

10.2 I/O Instructions

DOUT	Function	Turns the external output signals ON and OFF.	
	Additional Item	OT# (<output number>), OGH# (<output group number>), OG# (<output group number>)	
		Number of addressed output signals: OT#(xx)=1;OGH#(xx)=4(per group); OG#(xx)=8(per group)	
		OGH#(xx) is not subject to parity check; only the binary specification is allowed.	
	FINE	With a high degree of accuracy	
Example	DOUT OT#(12) ON		
PULSE	Function	Outputs a pulse signal as an external output signal.	
	Additional Item	OT# (<output number>), OGH# (<output group number>), OG# (<output group number>)	
		T=<time (seconds)>	0.01 to 655.35 s 0.30 s unless otherwise specified
	Example	PULSE OT# (10) T=0.60	

DIN	Function	Sets input signals in variables.	
	Additional Item	B<variable number>	
		IN# (<input number>), IGH# (<input group number>), IG# (<input group number>), OT# (<output number>), OGH# (<output group number>), OG# (<output group number>), SIN# (<system input number>), SOUT# (<system output number>)	
		Number of addressed input signals: IN#(xx)=1;IGH#(xx)=4(per group); IG#(xx)=8(per group)	
	Number of addressed output signals: OT#(xx)=1;OGH#(xx)=4(per group); OG#(xx)=8(per group)		
	IGH#(xx) and OGH#(xx) are not subject to parity check; only the binary specification is allowed.		
Example	DIN B016 IN#(16) DIN B002 IG#(2)		
WAIT	Function	Waits until the external input signal status matches the specified status.	
	Additional Item	IN# (<input number>), IGH# (<input group number>), IG# (<input group number>), OT# (<user output number>), OGH# (<output group number>), SIN# (<system input number>), SOUT# (<system output number>)	
		<status>,B<variable number>	
		T=<time (seconds)>	0.01 to 655.35 s
Example	WAIT IN# (12)=ON T=10.00 WAIT IN# (12)=B002		
AOUT	Function	Outputs the specified voltage to the general-purpose analog output port.	
	Additional Item	AO# (<output port number>)	1 to 40
		<output voltage(V)>	-14.0 to 14.0
Example	AOUT AO# (2) 12.7		

ARATION	Function	Starts the analog output corresponding to the speed.	
	Additional Item	AO#(<output port number>)	1 to 40
		BV = <basic voltage>	-14.00 to 14.00
		V = <basic speed>	0.1 to 150.0 mm/s 1 to 9000 cm/min
		OFV = <offset voltage>	-14.00 to 14.00
Example	ARATION AO#(1) BV=10.00 V=200.0 OFV=2.00		
ARATIOF	Function	Ends the analog output corresponding to the speed.	
	Additional Item	AO#(<output port number>)	1 to 40
	Example	ARATIOF AO#(1)	

10.3 Control Instructions

JUMP	Function	Jumps to the specified label or job.	
	Additional Item	* <label character string>,JOB:<job name>, IG# (<input group number>), B<variable number>, I<variable number>,D<variable number>	
		UF# (user coordinates number)	
		IF statement	
Example	JUMP JOB:TEST1 IF IN#(14)=OFF		
*(label)	Function	Indicates a jump destination.	
	Additional Item	<jump destination>	8 characters or less
	Example	*123	
CALL	Function	Calls the specified job.	
	Additional Item	JOB:<job name>,IG# (<input group number>), B<variable number>,I<variable number>, D<variable number>	
		UF# (user coordinates number)	
		IF statement	
Example	CALL JOB:TEST1 IF IN# (24)=ON CALL IG#(2) (The job is called by the patterns of input signal. In this example, Job 0 cannot be called.)		
RET	Function	Returns to the call source job.	
	Additional Item	IF statement	
	Example	RET IF IN#(12)=OFF	
END	Function	Declares the end of a job.	
	Additional Item		
	Example	END	

NOP	Function	No operation.	
	Additional Item		
	Example	NOP	
TIMER	Function	Stops for the specified time.	
	Additional Item	T=<time (seconds)>	0.01 to 655.35 s
	Example	TIMER T=12.50	
IF statement	Function	Evaluates the specified condition and makes a judgment accordingly. Described after an instruction that specifies a certain action. Format:<Item1>=,<>,<=,>=,<,><Item2>	
	Additional Item	<Item1>	
		<Item2>	
Example	JUMP *12 IF IN#(12)=OFF		
UNTIL statement	Function	Monitors the specified input signal during an action and stops the action when the specified signal status is observed. Described after an instruction that specifies a certain action.	
	Additional Item	IN# (<input number>)	
		<status>	
Example	MOVL V=300 UNTIL IN#(10)=ON		
PAUSE	Function	Instructs a pause.	
	Additional Item	IF statement	
	Example	PAUSE IF IN#(12)=OFF	
' (comment)	Function	Displays a comment.	
	Additional Item	<comment>	32 characters or less
	Example	'Draws 100mm size square.	

10.3 Control Instructions

CWAIT	Function	Waits for execution of the instruction on the next line. Used with the NWAIT tag which is an additional item of a move instruction.	
	Additional Item		
	Example	MOVL V=100 NWAIT DOUT OT#(1) ON CWAIT DOUT OT#(1) OFF MOVL V=100	
ADVINIT	Function	Initializes the prereading instruction processing. Used to adjust the access timing for variable data.	
	Additional Item		
	Example	ADVINIT	
ADVSTOP	Function	Stops the prereading instruction processing. Used to adjust the access timing for variable data.	
	Additional Item		
	Example	ADVINIT	

10.4 Shift Instructions

SFTON	Function	Starts a shift operation.		
	Additional Item	P<variable number>, BP<variable number>, EX<variable number>, BF,RF,TF, UF#(<user coordinate number>)	BF: base coordinates RF: robot coordinates TF: tool coordinates UF: user coordinates	
	Example	SFTON P001 UF#(1)		
SFTOF	Function	Stops a shift operation.		
	Additional Item			
	Example	SFTOF		
MSHIFT	Function	Obtains the shift value in the specified coordinate system from Data 2 and 3, and stores the obtained element values in Data 1. Format:MSHIFT <Data1><Coordinate><Data2><Data3>		
	Additional Item	Data1	PX<variable number>	
		Coordinate	BF,RF,TF, UF# (<user coordinate number>), MTF	BF: base coordinates RF: robot coordinates TF: tool coordinates UF: user coordinates MTF: tool coordinates for the master
		Data2	PX<variable number>	
		Data3	PX<variable number>	
	Example	MSHIFT PX000 RF PX001 PX002		

10.5 Operating Instructions

ADD	Function	Adds Data1 and Data2, and stores the result in Data1. Format:ADD<Data1><Data2>		
	Additional Item	Data1	B<variable number>, I<variable number>, D<variable number>, R<variable number>, P<variable number>, BP<variable number>, EX<variable number>	Data1 must always be a variable.
		Data2	Constant, B<variable number>, I<variable number>, D<variable number>, R<variable number>, P<variable number>, BP<variable number>, EX<variable number>	
	Example	ADD I012 I013		
SUB	Function	Subtracts Data2 from Data1, and stores the result in Data1. Format:SUB<Data1><Data2>		
	Additional Item	Data1	B<variable number>, I<variable number>, D<variable number>, R<variable number>, P<variable number>, BP<variable number>, EX<variable number>	Data1 must always be a variable.
		Data2	Constant, B<variable number>, I<variable number>, D<variable number>, R<variable number>, P<variable number>, BP<variable number>, EX<variable number>	
	Example	SUB I012 I013		

MUL	Function	<p>Multiplies Data1 by Data2, and stores the result in Data1. Format: MUL<Data1><Data2></p> <p>Data1 can be an element in a position variable. Pxxx(0):all axis data, Pxxx(1):X-axis data, Pxxx(2):Y-axis data, Pxxx(3):Z-axis data, Pxxx(4):Tx-axis data, Pxxx(5):Ty-axis data, Pxxx(6):Tz-axis data</p>		
	Additional Item	Data1	B<variable number>, I<variable number>, D<variable number>, R<variable number>, P<variable number> (<element number>), BP<variable number> (<element number>), EX<variable number> (<element number>)	Data1 must always be a variable.
		Data2	Constant, B<variable number>, I<variable number>, D<variable number>, R<variable number>	
	Example	MUL I012 I013 MUL P000 (3) 2 (Multiply the Z-axis data by 2.)		
DIV	Function	<p>Divides Data1 by Data2, and stores the result in Data1. Format: DIV<Data1><Data2></p> <p>Data1 can be an element in a position variable. Pxxx(0):all axis data, Pxxx(1):X-axis data, Pxxx(2):Y-axis data, Pxxx(3):Z-axis data, Pxxx(4):Tx-axis data, Pxxx(5):Ty-axis data, Pxxx(6):Tz-axis data</p>		
	Additional Item	Data1	B<variable number>, I<variable number>, D<variable number>, R<variable number>, P<variable number> (<element number>), BP<variable number> (<element number>), EX<variable number> (<element number>)	Data1 must always be a variable.
		Data2	Constant, B<variable number>, I<variable number>, D<variable number>, R<variable number>	
	Example	DIV I012 I013 DIV P000 (3) 2 (Divide the Z-axis data by 2.)		

10.5 Operating Instructions

INC	Function	Increments the value of the specified variable by 1.	
	Additional Item	B<variable number>,I<variable number>, D<variable number>	
	Example	INC I043	
DEC	Function	Decrements the value of the specified variable by 1.	
	Additional Item	B<variable number>,I<variable number>, D<variable number>	
	Example	DEC I043	
AND	Function	Obtains the AND of Data1 and Data2, and stores the result in Data1. Format:AND<Data1><Data2>	
	Additional Item	Data1	B<variable number>
		Data2	B<variable number>, Constant
	Example	AND B012 B020	
OR	Function	Obtains the OR of Data1 and Data2, and stores the result in Data1. Format:OR<Data1><Data2>	
	Additional Item	Data1	B<variable number>
		Data2	B<variable number>, Constant
	Example	OR B012 B020	
NOT	Function	Obtains the NOT of Data2, and stores the result in Data1. Format:NOT<Data1><Data2>	
	Additional Item	Data1	B<variable number>
		Data2	B<variable number>, Constant
	Example	NOT B012 B020	
XOR	Function	Obtains the exclusive OR of Data1 and Data2, and stores the result in Data1. Format:XOR<Data1><Data2>	
	Additional Item	Data1	B<variable number>
		Data2	B<variable number>, Constant
	Example	XOR B012 B020	

SET	Function	Sets Data2 to Data1. Format:SET<Data1><Data2>		
	Additional Item	Data1	B<variable number>, I<variable number>, D<variable number>, R<variable number>, P<variable number>, S<variable number>, BP<variable number>, EX<variable number>	Data1 must always be a variable.
		Data2	Constant, B<variable number>, I<variable number>, D<variable number>, R<variable number>, S<variable number>, EXPRESS	
	Example	SET I012 I020		
SETE	Function	Sets data to an element in a position variable.		
	Additional Item	Data 1	P<variable number> (<element number>), BP<variable number> (<element number>), EX<variable number> (<element number>)	
		Data 2	D<variable number>, <double-precision integer type constant>	
	Example	SETE P012 (3) D005		
GETE	Function	Extracts an element in a position variable.		
	Additional Item	D<variable number>		
		P<variable number> (<element number>), BP<variable number> (<element number>), EX<variable number> (<element number>)		
	Example	GETE D006 P012 (4)		

10.5 Operating Instructions

GETS	Function	Sets a system variable to the specified variable.	
	Additional Item	B<variable number>,I<variable number>, D<variable number>,R<variable number>, PX<variable number>	
		\$B<variable number>,\$I<variable number>, \$D<variable number>,\$R<variable number>, \$PX<variable number>, \$ERRNO, Constant, B<variable number>	System variable
Example	GETS B000 \$B000 GETS I001 \$I[1] GETS PX003 \$PX001		
CNVRT	Function	Converts the position variable (Data2) into a position variable of the specified coordinate system, and stores the converted variable in Data1. Format:CNVRT<Data1><Data2><coordinate>	
	Additional Item	Data1	PX<variable number>
		Data2	PX<variable number>
		BF,RF,TF,UF# (<user coordinate number>),MTF	BF: base coordinates RF: robot coordinates TF: tool coordinates UF: user coordinates MTF:tool coordinates for the master
Example	CNVRT PX000 PX001 BF		

CLEAR	Function	Starting with the variable number in Data1, clears (sets to zero) as many variables as specified by a number in Data2. Format: CLEAR<Data1><Data2>		
	Additional Item	Data1	B<variable number>,I<variable number>, D<variable number>,R<variable number>, \$B<variable number>,\$I<variable number>, \$D<variable number>,\$R<variable number>,	
		Data2	<number of variables>, ALL,STACK	ALL:Clears variables of the variable number in Data1 and of all the variable numbers that follow. STACK:Clears all variables in the job call stack.
	Example	CLEAR B000 ALL CLEAR STACK		
SIN	Function	Obtains the sine of Data2, and stores the result in Data1. Format: SIN<Data1><Data2>		
	Additional Item	Data1	R<variable number>	Data1 must always be a real type variable.
		Data2	<constant>,R<variable number>	
	Example	SIN R000 R001 (Sets the sine of R001 to R000.)		
COS	Function	Obtains the cosine of Data2, and stores the result in Data1. Format: COS<Data1><Data2>		
	Additional Item	Data1	R<variable number>	Data1 must always be a real type variable.
		Data2	<constant>,R<variable number>	
	Example	COS R000 R001 (Sets the cosine of R001 to R000.)		

ATAN	Function	Obtains the arc tangent of Data2, and stores the result in Data1. Format: ATAN<Data1><Data2>		
	Additional Item	Data1	R<variable number>	Data1 must always be a real type variable.
		Data2	<constant>,R<variable number>	
	Example	ATAN R000 R001 (Sets the arc tangent of R001 to R000.)		
SQRT	Function	Obtains the square root of Data2, and stores the result in Data1. Format: SQRT<Data1><Data2>		
	Additional Item	Data1	R<variable number>	Data1 must always be a real type variable.
		Data2	<constant>,R<variable number>	
	Example	SQRT R000 R001 (Sets the square root of R001 to R000.)		
MFRAME	Function	Creates a user coordinate using the position data for the given three points as definition points. <Data1> indicates the definition point ORG position data, <Data2> the definition point XX position data, and <Data3> the definition point XY position data. Format: MFRAME <user coordinate> <Data1> <Data2> <Data3>		
	Additional Item	UF#(<user coordinate number>)		1 to 24
		Data1	PX <variable number>	
		Data2	PX <variable number>	
		Data3	PX <variable number>	
Example	MFRAME UF#(1) PX000 PX001 PX002			
MULMAT	Function	Obtains the matrix product of Data2 and Data3, and stores the result in Data1. Format: MULMAT <Data1> <Data2> <Data3>		
	Additional Item	Data1	P <variable number>	
		Data2	P <variable number>	
		Data3	P <variable number>	
Example	MULMAT P000 P001 P002			

INVMAT	Function	Obtains the inverse matrix of Data2, and stores the result in Data1. Format: INVMAT <Data1> <Data2>		
	Additional Item	Data1	P <variable number>	
		Data2	P <variable number>	
Example	INVMAT P000 P001			
SETFILE	Function	Changes the contents data of a condition file into the numeric data of Data1. The contents data of a condition file to be changed is specified by the element number.		
	Additional Item	Contents data of a condition file	WEV#(<condition file number>)(<element number>)	
		Data1	Constant, D<variable number>	
Example	SETFILE WEV#(1)(1) D000			
GETFILE	Function	Stores the contents data of a condition file in Data1. The contents data of a condition file to be obtained is specified by the element number.		
	Additional Item	Data1	D <variable number>	
		Contents data of a condition file	WEV#(<condition file number>)(<element number>)	
Example	GETFILE D000 WEV#(1)(1)			
GETPOS	Function	Stores the position data of Data2 (step number) in Data1.		
	Additional Item	Data1	PX <variable number>	
		Data2	STEP# (<step number>)	
Example	GETPOS PX000 STEP#(1)			
VAL	Function	Converts the numeric value of the character string (ASCII) of Data2 into the real number, and stores the result in Data1. Format: VAL <Data1> <Data2>		
	Additional Item	Data1	B <variable number>, I <variable number>, D <variable number>, R <variable number>	
		Data2	Character string, S <variable number>	
Example	VAL B000 "123"			

ASC	Function	Obtains the character code of the first letter of the character string (ASCII) of Data2, and stores the result in Data1. Format:ASC<Data1><Data2>		
	Additional Item	Data1	B <variable number>, I <variable number>, D <variable number>	
		Data2	Character string, S <variable number>	
Example	ASC B000 "ABC"			
CHR\$	Function	Obtains the character (ASCII) with the character code of Data2, and stores the result in Data1. Format:CHR\$<Data1><Data2>		
	Additional Item	Data1	S <variable number>	
		Data2	Constant, B <variable number>	
Example	CHR\$ S000 65			
MID\$	Function	Obtains the character string (ASCII) of any length (Data 3, 4) from the character string (ASCII) of Data2, and stores the result in Data1. Format:MID\$<Data1><Data2><Data3><Data4>		
	Additional Item	Data1	S <variable number>	
		Data2	Character string, S <variable number>	
		Data3	Constant, B <variable number>, I <variable number>, D <variable number>	
		Data4	Constant, B <variable number>, I <variable number>, D <variable number>	
Example	MID\$ S000 "123ABC456" 4 3			
LEN	Function	Obtains the total number of bytes of the character string (ASCII) of Data2, and stores the result in Data1. Format:LEN<Data1><Data2>		
	Additional Item	Data1	B <variable number>, I <variable number>, D <variable number>	
		Data2	Character string, S <variable number>	
Example	LEN B000 "ABCDEF"			

CAT\$	Function	Combines the character string (ASCII) of Data2 and Data3, and stores the result in Data1. Format:CAT\$<Data1><Data2><Data3>		
	Additional Item	Data1	S <variable number>	
		Data2	Character string, S <variable number>	
		Data3	Character string, S <variable number>	
Example	CAT\$ S000 "ABC" "DEF"			

11 Error

11.1 Error Message List

Error warns the operator not to advance to the next operation caused by a wrong operation or the access method when using the programming pendant or an external equipment (computer, PLC, etc.).

When an error occurs, confirm the content of the error then release the error.

To release the error, perform either of the following operations:

- Press [CANCEL] on programming pendant.
- Input alarm/error reset signal (system input).



An error is different from an alarm because it does not stop the robot even if it occurred while the robot was operated (during playback).

Main Menu

ShortCut



Cannot insert/modify/delete for axis detachment

11.1.1 System and General Operation

Error No.	Data	Error Message	Contents
10	-	Turn off servo power and perform corrective action	It cannot be operated while servo power supply is ON.
20	-	Depress TEACH	Out of specified operation mode
30	-	Illegal setting for number of variables	Parameter setting error
40	-	Undefined robot position variables	Position variable cannot be used.
60	-	Undefined points (ORG, XX, XY)	Not registered user coordinates basic 3 points (ORG, XX, XY)
70	-	Program and current tool different	The tool number registered with teaching position data does not match the tool number selected at the programming pendant.
80	-	Same position in the 3 points	
100	-	On overrun recovery status	
110	-	Turn ON servo power	
120	-	Set to PLAY mode	
130	-	No start using external signal	
140	-	No start using P.P.	
180	-	TEACH mode select signal ON	
190	-	Set variable number	
200	-	Defined group axis	
210	-	Undefined coordinated robots	
212	-	Cannot register group combination	
230	-	While releasing soft limit	
240	-	Undefined robot	
270	-	Undefined gun condition file	
280	-	Lack of number of I/O points	
290	-	Cannot set same No.	
300	-	Undefined user frame	
310	-	Cannot register Master JOB	
320	-	Cannot operate CHECK-RUN	
330	-	Cannot operate MACHINE LOCK	

11.1 Error Message List

Error No.	Data	Error Message	Contents
340	-	Cannot operate Master JOB	
350	-	Cannot initialize	
380	-	Position not checked	Second home position was not checked.
390	-	Can specify servo off by safety relay	
410	-	Time could not be measured	Time could not be measured for TRT function.
420	-	Incorrect number of taught points	The number of the taught points for tool calibration is incorrect.
430	-	Register start reserved JOB	
460	-	Excess time for measuring	
500	-	Undefined robot calibration data	
510	-	Undefined axis	
520	-	Cannot select two coordinated combination	
530	-	Start reservation mode	
550	-	Start reserved JOB change prohibit is set	
560	-	Cannot teach position while soft limit released	
590	-	Register group axis combination	[SYNCHRO] was pressed for coordinated job which was not registered as group.
600	-	Out of setting data range	
610	-	Cannot use the user coordinate	
620	-	Select JOB (robot)	
650	-	Incorrect measured data	
660	-	Wrong data type of position variable	
680	-	Defined data	
	XXX		File No.
700	-	Wrong CMOS memory board type	
760	-	Error in start condition set	
770	-	During robot operation	
800	-	The gun of designation is not connected	

Error No.	Data	Error Message	Contents
801	-	The group axis of designation is not connection	
810	-	Servo power supply is limited	
820	-	Modification range over	
930	-	Undefined conveyor calibration data	
940	-	Forced pressure signal ON	
950	-	Negative correction distance	
960	-	I/O axis mode requesting	
970	-	ERRSVCPU signal error	

11.1.2 Editing

Error No.	Data	Error Message	Contents
1010	-	EDIT LOCK mode	
1020	-	Enter correct value	
1030	-	Unauthorized ID No.	
1050	-	Enter correct date	
1060	-	Enter correct clock	
1070	-	Enter an ID number in 4-8 figures	
1080	-	Negative value can't be set	

11.1.3 Job Defined Data

Error No.	Data	Error Message	Contents
2010	-	Incorrect character	
2020	-	Name not entered	
2030	-	Undefined JOB name	
2040	-	Defined JOB name	
2050	-	Address not found	
2070	-	Set robot exactly to taught position	
2080	-	Press INSERT or MODIFY	
2090	-	Only modifying move instruction possible	
2100	-	JOB cannot be edited.	
2110	-	Over soft limit	
2120	-	Cannot insert/alter/delete with servo off	
2150	-	Inserting is not possible from this point	
2160	-	Cannot modify or delete this position	
2170	-	Press INSERT to record same step as previous step	
2180	-	Cannot insert data	
2210	-	Illegal data setting	
2220	-	Display edit instruction	
2240	-	Excessive instruction equation	

Error No.	Data	Error Message	Contents
2250	-	Unmatched number of parentheses in equation	
2260	-	Wrong group axis selection	
2270	-	Cannot insert any more instruction in JOB	
2280	*	JOB memory is full	
	1		Lack of position file memories
	2		Lack of JOB registering memories
	3		Lack of instruction file memories
	4		Lack of memory pool
	5		Lack of pass condition file for multi-layer
2290	-	Undefined master JOB	
2291	*	Undefined SUB Master JOB	
	1		Sub-master 1
	2		Sub-master 2
	3		Sub-master 3
	4		Sub-master 4
	5		Sub-master 5
	6		Sub-master 6
	7		Sub-master 7
	8		Sub-master 8
2292	-	Undefined MASTER START JOB	
2293	*	Undefined SUB START JOB	
	1		Sub-master 1
	2		Sub-master 2
	3		Sub-master 3
	4		Sub-master 4
	5		Sub-master 5
	6		Sub-master 6
	7		Sub-master 7
	8		Sub-master 8

11.1 Error Message List

Error No.	Data	Error Message	Contents
2300	-	Cannot teach JOB without group-axis specification	
2310	*	Same label exists	
	XXX		Line No.
2340	-	Pasted data not found	
2360	-	Cannot create editing area	
2370	-	Cannot cut/copy NOP and END instructions	
2390	-	Wrong group axis selection	
2400	-	Cannot move in cut & paste editing	
2430	-	Reverse data not found	
2440	-	Move C-and W-axis to basic position	Laser cutting
2450	-	Relative JOB not permitted	
2470	-	Wrong JOB type	
2480	-	Wrong JOB coordinates setting	
2500	-	Cannot convert the JOB	
2510	-	Cannot correct position in the JOB	
2520	-	Enter JOB name	
2530	-	Illegal step number	
2540	-	Enter step number	
2550	-	Duplicated step number	
2551	-	Duplicated line number	
2560	-	Cannot correct steps of position variables and REFP	
2570	-	The step does not contain speed	
2580	-	The step dose not contain PL/CONT	
2590	-	Soft limit range over	
2600	-	Cannot teach position in concurrent JOB	
2610	-	Wrong JOB kind	
2620	-	Cannot correct play speed in the JOB	
2630	-	Conveyor position not reset	

Error No.	Data	Error Message	Contents
2640	-	Incorrect JOB name	
2670	-	Undefined target JOB	
2710	-	Relative job can't be shifted with pulse type	
2730	-	Cannot use robot macro JOB	
2740	-	Cannot use concurrent macro JOB	
2750	-	Cannot use JOB with group-axis specification	
2760	-	Cannot insert/modify/delete for group axis detachment	
2761	-	Axis is separated. Cannot add, modify, or delete.	
2770	-	Cannot reverse data of SVSPOTMOV instruction	
2780	-	Arithmetic error	

11.1.4 External Memory Equipment

Error No.	Data	Error Message	Contents
3010	-	Floppy disk drive cable not connected	
3020	-	Floppy disk not inserted into floppy disk drive	
3030	-	Floppy disk protection is ON	
3040	-	File not saved on floppy disk or Compact Flash	
3050	-	File saved on floppy disk or Compact Flash	
3060	-	Out of memory on floppy disk or Compact Flash	
3070	-	Number of files on floppy disk or Compact Flash is full	
3080	-	I/O error on floppy disk or Compact Flash	
3090	*	Transmission error with floppy disk or Compact Flash	
	1		Framing error
	2		Overrun error
	3		Parity error
	4		Data code error
	5		Data read error
	6		Data write error
	7		Data time out
	8		Serial I/O error
9		Error other than described above	
3110	-	Syntax error	
3120	*	HEX code error	
	1		Specification error of data decode
	2		Specification error of EOF record
	3		Record type error
	4		Total check error of record
3130	-	Verify error	

Error No.	Data	Error Message	Contents
3140	-	Wrong pseudo instruction	
3150	*	Concurrent I/O record error	
	1		Format error
	2		Ladder program is too long.
	3		Exceed the range of the data
	4		Specification error of channel No.
	5		Specification error of relay No.
	6		Timer value error
	7		Specification error of timer No.
3160	-	Cannot load illegal system data	
3170	*	Condition file data error	
	1		Format error
	2		Specified file No. is omitted.
	3		Specified tool No. is omitted.
	4		User file is not registered.

11.1 Error Message List

Error No.	Data	Error Message	Contents
3190	*	Error in JOB data record	
	1		Record on the number of position data (NPOS) is wrong for the format.
	2		Record on the user coordinate No. (USER) is wrong for the format.
	3		Record on the tool No. (TOOL) is wrong for the format.
	4		Record on the position data section is wrong for the format.
	5		Record on the robot type of XYZ data (RCONF) is wrong for the format.
	6		Date (DATE) record is wrong for the format.
	7		Comment (COMM) record is wrong for the format.
	8		Record on the JOB attribute data (ATTR) is wrong for the format.
	9		Control group (GROUP) record is wrong for the format.
	10		Local variable (LVAR) record is wrong for the format.
	11		JOB argument (JARGS) record is wrong for the format.
	12		Record on the teaching coordinates for relative job (FRAME) is wrong for the format.
	13		Position data coordinates do not match relative job coordinates.
3200	-	NOP or END instruction not found	
3210	-	Position No. storage area not found	
3220	*	Syntax error in instruction data	
	2		Interior control error
	3		Undefined instruction/tag
	4		Instruction/tag shortage
	5		Disuse instruction/tag
	6		Sub instruction

Error No.	Data	Error Message	Contents
3220	7		No instruction
	8		Invalid instruction
	9		Invalid tag
	10		Invalid character
	11		Undefined intermediate code
	12		Intermediate code shortage
	13		Syntax stack overflow
	14		Syntax stack underflow
	15		Array type tag incomplete Tag [ARRAY]
	16		Element type tag incomplete Tag [ELEMENT]
	17		Macro JOB unregistered
	18		Input format error
	19		Data size over
	20		MIN value over
	21		MAX value over
	22		Operation expression error
	23		Job call argument setting error
	24		Macro job call argument setting error
	25		Position vector setting error
	26		System error
	27		Soft key designate error
	28		Numerical input buffer overflow
	29		Real type data precision error
	30		Element format error
	35		BOOL TYPE data error
	36		CHAR data error
	37		BYTETYPE, BINARY / HEXADECI- MAL BYTE TYPE data error
	38		INTEGER TYPE, DECIMAL WORD TYPE data error

11.1 Error Message List

Error No.	Data	Error Message	Contents
3220	39		BINARY/HEXADECIMAL WORD TYPE data error
	40		DOUBLE PRECISION INTEGER TYPE, DECIMAL DWORD TYPE data error
	41		BINARY/HEXADECIMAL WORD TYPE data error
	42		REAL TYPE data error
	43		LADDER SPECIAL TYPE data error
	44		JCL text
	45		Invalid text
	46		LABEL NAME data error
	47		JOB NAME data error
	48		STRING data error
	49		COMMENT data error
	58		Invalid instruction/tag detection
3230	-	Syntax not matched	
3240	-	Undefined application	
3250	-	Cannot load this file	
3260	-	Excess input data	
3270	-	Cannot verify this file	
3280	-	Wrong welding condition (STANDARD/ ENHANCED)	
3290	-	Serial port not defined	
3300	-	Serial port being used	
3310	-	Protocol being used	
3350	-	Not enough memory	
3360	-	Invalid folder	
3370	-	Incorrect folder name	
3450	-	Cannot load macro JOB at current security mode	Load in management mode.

Error No.	Data	Error Message	Contents
3460	*	Cannot backup Compact Flash	
	1		Insufficient Compact Flash memory.
	2		Not accessible to Compact Flash.
3470	-	Database not found	
3480	-	Database access error	
3490	-	Same database exists	
3500	-	Check Compact Flash insertion	
3510	-	Cannot delete folder. Check attribute and inside file	
3520	-	Same folder exists	
3530	-	Cannot load at current security mode	

11.1.5 Concurrent I/O

Error No.	Data	Error Message	Contents
4010	*	Illegal relay No.	
	XXX		Line No.
4030	*	Illegal instruction	
	XXX		Line No.
4040	*	Relay/register No. duplicated in OUT/ GOUT or arithmetic instruction	Multiple outputs are instructed to the relay or register.
	XXX		Line No.
4050	*	The relay is not used	
	XXX		Line No.
4060	*	Excess STR [-NOT] instructions	
	XXX		Line No.
4070	*	Excess AND [OR] STR instructions	
	XXX		Line No.
4080	*	Syntax error in CNT instructions	
	XXX		Line No.
4090	*	Enter STR [-NOT] at head of block	Need STR [-NOT]
	XXX		Line No.
4120	-	Concurrent I/O memory is full	Exceeds memory capacity (10000 steps)
4130	-	END instruction not found	END instruction not found
4140	-	Wrong ladder program	Position and number of PART instruction are wrong.
4150	*	Wrong use of GSTR, GOUT commands	GSTR and GOUT is not used together.
	XXX		Line No.
4220	-	Excess TMR/CNT or arithmetic instruc- tions	More than 100 TMR, CNT or arithmetic instruction used
4230	-	Syntax error in TMR/CNT instructions	

11.1.6 Maintenance Mode

Error No.	Data	Error Message	Contents
8010	-	Too many axes	
8020	-	Too many I/O points	
8030	-	Too many boards (XFB01B (MASTER))	
8031	-	Too many boards (MSC01B)	
8040	-	Memory error (ControlNet output condition)	
8041	-	Memory error (UNIWIRED CONNECT DAT	
8050	-	Robot model is not registered	
8060	-	Cannot get UNIWIRED connection data	

Symbols

* (label)	10-8
' (comment)	10-9

A

ADD	10-10, 10-12, 10-19
additional items	3-4
ALARM HISTORY	1-21
alarm history data	7-7
ALL CMOS AREA	7-6
alphanumeric input	1-17
ANALOG MONITOR	1-21
AND	10-14
AOUT	10-6
application parameter	7-7
ARATIOF	10-7
ARATION	10-7
arc end condition data	7-6
arc start condition data	7-6
AREA key	1-5
ARM CONTROL	1-21
ASSIST key	1-9
ATAN	10-18
AUTO BACKUP SET	1-22
axis keys	1-2, 1-6

B

BACK SPACE key	1-9
base axis	1-12
base reverse paste	3-51
basic axis	2-6, 2-7
BATCH CMOS	7-6
batch selection	7-43
BATCH USER MEMORY	7-6
B-axis	2-5
BWD key	1-7, 3-19
byte type	3-64

C

CALL	9-27, 10-8
CANCEL key	1-7
cartesian coordinates	1-12, 2-2, 2-6
character input	1-15
character string type	3-64
check mode operation	4-12
circular interpolation	3-7
CLEAR	10-17
CIO parameter	7-7
CNVRT	10-16
COMMAND POSITION	1-21

COMMAND POSITION window	3-37
comments	3-4
concurrent I/O program	7-7
Continuous (operation cycle)	1-13
continuous circular arcs	3-7
continuous spline curves	3-8
Control	1-12
Control Group	1-12
control groups	3-3
control instructions	3-40
Converter parameter	7-7
COORD key	1-5
coordinate home position parameter	7-7
coordinate system	1-12
copy	3-51, 3-54
copying jobs	5-2
COS	10-17
CREATE NEW JOB	1-20
CURRENT POSITION	1-21
cursor	3-4
cursor key	1-2, 1-4
cut	3-51, 3-54
Cycle (operation cycle)	1-13
cycle time	4-5
cylindrical coordinates	1-12, 2-2, 2-7

D

DATE/TIME	1-22
DEC	10-14, 10-21
DELETE	1-21
DELETE key	1-7
deleting a file	7-42
deleting a job	5-6, 7-41
deleting additional items	3-50
deleting instructions	3-44
DEVICE	1-21
DIN	10-6
direct open	6-1
DIRECT OPEN key	1-5
DIV	10-13, 10-20
double precision integer type	3-64
DOUT	10-5
DROP AMOUNT	1-21
dry-run speed operations	4-11

E

edit lock on individual job units	5-12
edit mode	1-13, 1-19
editing comments	5-11
editing condition files	3-63
editing interpolation type	3-62
editing play speed	3-58
emergency stop	4-14
emergency stop button	1-4, 3-1
Enable switch	1-2, 1-4
END	10-8

ENTER key 1-2, 1-7
error message list 11-1
EX.AXIS key 1-6
External Axis 2-13
external memory devices 7-1

F

FD/PC CARD 1-21
file management 7-10
FILE/ GENERAL DATA 7-6
flip/no flip 3-76
FOLDER 1-21
FORMAT 1-21
function definition parameter 7-7
Function Keys 9-1
function keys 1-2
FWD key 1-7, 3-19

G

general-purpose display area 1-2, 1-10
GETE 10-15
GETS 10-16
group operation axis 1-12
GRP COMBINATION 1-22

H

high speed 1-13
HIGH SPEED key 1-5
hold at the station 4-31
hold by external input signal (system input) ... 4-30
hold by HOLD key 4-30
HOLD key 1-8
hold operation 4-13
HOME POSITION 1-21
home position calibrating data 7-7
human interface display area 1-10, 1-14

I

I/O DATA 7-7
I/O instructions 3-40
I/O MSG HISTORY 1-21
I/O name data 7-7
IF 10-9
IMOV 10-3
IN/OUT 1-20
INC 10-14, 10-20
inching 1-13
individual selection 7-43

INFORM LIST key 1-7
INSERT key 1-7
inserting additional items 3-49
inserting instructions 3-41
insertion slot for compact flash 1-2
instruction group 3-39
instruction search 3-86
integer type 3-64
INTERFERENCE 1-21
INTERLOCK key 1-8
interpolation type 3-5, 3-11
INVMAT 10-19

J

JOB 1-20, 7-6
JOB CAPACITY 1-20
JOB CAPACITY window 3-38
JOB CONTENT window 3-36
JOB HEADER window 3-34
job stack 4-32
joint coordinates 1-12, 2-2, 2-5
joint interpolation 3-5
JUMP 10-8

K

KEY ALLOCATION 1-22
keypads 1-15

L

label search 3-85
L-axis 2-5
LIMIT RELEASE 1-21
limited speed operations 4-10
line number 3-4
line search 3-84
linear interpolation 3-6
LOAD 1-21
loading a condition file or general data 7-29
loading a job 7-27
loading a parameter 7-31
loading all CMOS data 7-37
loading all data in CMOS area 7-38
loading all user's programs 7-36
loading I/O data 7-33
loading system data 7-34
local variables 3-80
low speed 1-13
low speed operation 4-10

M

machine lock operation	4-11
main menu area	1-10, 1-12
MAIN MENU key	1-4, 1-9
major alarms	4-17
major axes	2-5
management mode.....	1-13, 1-19
manipulator coordinate systems.....	2-1
MANIPULATOR TYPE	1-21
manipulator type.....	3-76
manual speed	1-13, 3-21
MANUAL SPEED keys	1-2, 1-5
MASTER JOB	1-20
master job	4-2
medium speed	1-13
menu area	1-2, 1-10, 1-14
MFRAME.....	10-18
minor alarms	4-17
mirror shift function	6-43
Mode.....	1-13
mode switch.....	1-8
modification of speed type.....	3-58
MODIFY key	1-7
modifying additional items	3-48
modifying additional numeric data	3-47
modifying instructions	3-44
modifying job names.....	5-8
MONITORING TIME.....	1-21
motion function parameter.....	7-7
motion time.....	4-5
MOTION TYPE key	1-2, 1-6
motor gun dry spot pressure data.....	7-6
motor gun pressure power data	7-6
MOV C.....	10-2
move instructions	3-9, 3-40
MOV J.....	10-1
MOV L	10-2
MOV S	10-3
MSHIFT.....	10-11
MUL.....	10-10, 10-13, 10-19, 10-20
MULMAT	10-18

N

NOP.....	10-9
NOT	10-14
Numeric keys	1-2, 1-8

O

OPE ORIGIN POS	1-21
OPERATE COND.....	1-22, 4-23
operating instructions.....	3-40
operation control parameter.....	7-7
operation cycle.....	1-13, 4-6
operation mode	1-13, 1-19

OR.....	10-14
override speed settings.....	4-5
OVERRUN&S-SENSOR	1-21

P

Page	1-13
page	1-13
PAGE key	1-2, 1-5
Painting Application	9-1
PAINTSET.....	9-21
PAM function	6-35
parallel shift function.....	6-3
parallel shift job conversion function.....	6-16
PARAMETER	1-22, 7-7
PARAMETER BATCH	7-7
paste.....	3-51, 3-55
PAUSE	10-9
play mode	1-18
play speed.....	3-5, 3-12
playback.....	4-1
playback time.....	4-5
position level.....	3-12
position type	3-64
POWER ON/OFF POS	1-21
Power Source characteristic data.....	7-6
Power Source characteristic definition data.....	7-6
programming pendant.....	1-2
programming pendant display	1-10
PULSE	10-5
pulse mirror-shift function	6-43

R

R-axis	2-5
r-axis.....	2-7
real type	3-64
reference point instructions	3-15
REFP	10-4
registering a job	3-2
related job (job+condition)	7-6
relative modification.....	3-58
remote mode	1-18
RES. START(CNCT)	1-22, 4-24
RES. START(JOB).....	1-20
RES. STATUS	1-20, 4-28
RESERVE JOB NAME	1-22
reserved start.....	4-22
RESET RESERVATION	4-29
restart	4-13
RET	10-8
reverse paste.....	3-51, 3-56
ROBOT	1-21
robot axis	1-12
ROBOT CALIB.....	1-21
ROBOT key	1-6
robot matching parameter	7-7
robot-coordinates mirror-shift function	6-43

S

SAVE	1-21
saving a condition file or general data	7-17
saving a job	7-11, 7-12, 7-13, 7-15
saving a parameter	7-19
saving all CMOS data	7-25
saving all data in CMOS area	7-26
saving all user's programs	7-24
saving I/O data	7-21
saving system data	7-22
S-axis	2-5
SECOND HOME POS	1-21
second home position	7-7
security mode	1-13, 1-19
SELECT JOB	1-20
SELECT key	1-2, 1-4
selecting the range	3-53
sensor parameter	7-7
SERVO MONITOR	1-21
SERVO ON READY key	1-9
servo parameter	7-7
servo power block parameter	7-7
servomotor parameter	7-7
SERVOPACK parameter	7-7
SET	10-15
SET SPEED	1-22
SETE	10-15
SETUP	1-22
SFTOF	10-11
SFTON	10-11
shift instructions	3-40, 6-7
SHIFT key	1-8
shift value	6-5
shock detection level data	7-6
short/full open position data	7-6
SIN	10-17
single circular arc	3-7
single job	7-6
single spline curve	3-8
special playback operations	4-9
SPEED	10-4
speed override	4-18
spline interpolation	3-8
spot gun characteristic data	7-6
spot welding Power Source characteristic data	7-6
SPYOF	9-15
SPYON	9-9
SQRT	10-18
START key	1-8, 3-1
start No.	4-5
state under execution	1-13
station axis	1-12
status display area	1-10, 1-12
Step (operation cycle)	1-13
step search	3-84
stop	4-13
stop by alarm	4-16
SUB	10-10, 10-12, 10-19, 10-20
SV monitor signals	7-7
symbol input	1-17
SYSTEM DATA	7-7
system definition parameter	7-7

SYSTEM INFO	1-21
system information	7-7
system matching parameter	7-7

T

tag search	3-87
T-axis	2-5
teach lock	3-1
teach mode	1-18
teaching	3-1
TEACHING COND	1-22
test operations	3-22, 3-57
TEST START key	1-6
theta(q)-axis	2-7
TIMER	10-9
timer instruction	3-16
TOOL	1-21
tool coordinates	1-12, 2-2, 2-8
tool data	7-6
tool number	2-9, 3-11
transmission(general) parameter	7-7
TRT	3-60

U

U-axis	2-5
undo	3-31
UNTIL	10-9
USER COORDINATE	1-21
user coordinate data	7-6
user coordinate number	2-12
user coordinates	1-12, 2-2, 2-10
USER ID	1-22
User Variables	3-64
user variables	3-64
user word registration	7-7
user-coordinates mirror-shift function	6-43

V

VARIABLE	1-20
variable data	7-6
variable name	7-7
VERIFY	1-21
verifying a file	7-40
verifying a job	7-38
verifying data	7-38
VERSION	1-21

W

WAIT.....	10-6
Weak Battery of Memory.....	1-13
weaving data	7-6
weaving prohibit	4-12
work instructions	3-40
wrist axis	2-5, 2-6, 2-7
WRONG DATA LOG	1-22

X

X-axis.....	2-6
XOR.....	10-14

Y

Y-axis.....	2-6
-------------	-----

Z

Z-axis.....	2-6, 2-7
-------------	----------

NX100

OPERATOR'S MANUAL

FOR PAINTING

HEAD OFFICE

2-1 Kurosakishiroishi, Yahatanishi-ku, Kitakyushu 806-0004 Japan
Phone +81-93-645-7745 Fax +81-93-645-7746

YASKAWA America Inc. MOTOMAN Robotics Division
805 Liberty Lane, West Carrollton, OH 45449, U.S.A.
Phone +1-937-847-6200 Fax +1-937-847-6277

YASKAWA Nordic AB
Franska vagen 10, Box 4004, 390 04 Kalmar, Sweden
Phone +46-480-417800 Fax +46-480-417999

YASKAWA Europe GmbH Robotics Division
Kammerfeld strasse 1, 85391 Allershausen, Germany
Phone +49-8166-90-100 Fax +49-8166-90-103

YASKAWA Electric Korea Co., Ltd.
7F, Doore Bldg.; 24, Yeoido-Dong Youngdungpo-ku, Seoul, KOREA
Phone +82-2-784-7844 Fax +82-2-784-8495

YASKAWA Electric (Singapore) PTE Ltd.
151 Lorong Chuan, #04-02A, New Tech Park, Singapore 556741
Phone +65-6282-3003 Fax +65-6289-3003

YASKAWA Electric (Thailand) Co., Ltd.
252/246, 4th Floor. Muang Thai-Phatra Office Tower II Rachadaphisek Road, Huaykwang Bangkok, 10320 Thailand
Phone +66-2-693-2200 Fax +66-2-693-4200

Shougang MOTOMAN Robot Co. Ltd.
No.7, Yongchang-North Road, Beijing E&T Development Area, China 100176
Phone +86-10-6788-2858 Fax +86-10-6788-2878

MOTOMAN Motherson Robotics Ltd.
Plot No.195-196, 1st Floor, Sec.4 IMT Manesar, Gurgaon 122050, Haryana
Phone +91-124-475-8500 Fax +91-124-414-8016

Specifications are subject to change without notice
for ongoing product modifications and improvements.

YASKAWA ELECTRIC CORPORATION



MANUAL NO. RE-CSO-A036 
© Printed in Japan July 2010 03-10